

LEMAN[®]

PROFESSIONAL CUTTING SOLUTIONS

OVER
40
YEARS



Depuis plus de 40 ans, LEMAN renouvelle sans cesse son expertise pour proposer la meilleure sélection d'outils coupants aux professionnels du bâtiment.

Répondre à leurs besoins grâce à des gammes efficaces, quelle que soit la configuration rencontrée, est notre priorité.

QUALITÉ

PROFESSIONNALISME

Nos produits sont conformes aux normes en vigueur et font l'objet de certifications volontaires pour garantir leurs caractéristiques techniques et la sécurité des utilisateurs.

Nos gammes sont déclinées sur 2 niveaux de qualité :

EXPERT  pour les travaux spécialisés et de haute technicité,
CLASSIC  pour les travaux courants et polyvalents.

Pour assurer une parfaite fiabilité de nos gammes, nous nous engageons à sélectionner les fabrications et les origines de nos produits au meilleur rapport qualité / prix.

PROXIMITÉ

RÉACTIVITÉ

Une entreprise à taille humaine, souple & réactive :

- Des offres promotionnelles et attractives toute l'année.
- Disponibilité de nos produits en 24/48h maximum.
- SAV

L'expérience au service de l'utilisateur :

- 8000 réfs. en stock.
- 5 vendeurs conseils sédentaires
- 10 technico-commerciaux sur le terrain
- Vidéos et services en ligne



CHOIX

CONSEILS D'EXPERT

Pour que chaque utilisateur identifie facilement et de façon fiable la solution la plus adaptée à son besoin, nos produits évoluent pour assurer une lisibilité et une identification facile de leurs destinations.



Une gamme complète pour tous types de découpes mécanisées : disques diamant, disques à tronçonner, lames de scie circulaire, trépan.... et un large choix d'outils complémentaires à découvrir sur leman-sa.com.

-  BOIS MASSIF
-  PANNEAUX & DÉRIVÉS DU BOIS
-  ASPHALTE
-  MAÇONNERIE
-  CARRELAGE
-  MÉTAL
-  MULTI-MATÉRIAUX
-  PIERRE & TUILE
-  PLÂTRE & MATÉRIAUX TENDRES
-  ACCESSOIRES





COUPE ET SCIAGE

PERÇAGE ET FAÇONNAGE

SURFAÇAGE

VISSAGE ET ACCESSOIRES

MACHINES

SOMMAIRE



OUTILS DIAMANTÉS	P. 4
DISQUES À TRONÇONNER	P. 34
TRÉPANS	P. 50
LAMES DE SCIE CIRCULAIRE	P. 68
LAMES DE SCIE SAUTEUSE ET SCIE SABRE	P. 110
LAMES DE SCIE À RUBAN	P. 140

PERÇAGE	P. 152
PERÇAGE SPÉCIAL	P. 176
DÉFONÇAGE	P. 192
ALÉSAGE 30	P. 240
FERS ET PLAQUETTES	P. 286
MORTAISAGE	P. 306

DISQUES À LAMELLES ET MEULES	P. 326
ABRASIFS	P. 340
BROSSES	P. 382
MULTI-TOOLS	P. 406

VISSAGE	P. 416
TOURNAGE ET CISEAUX À BOIS	P. 432
SERRAGE ET SERVANTES	P. 444
ACCESSOIRES	P. 454

BOIS	P. 466
BÂTIMENT	P. 508
MÉTAL	P. 530
OUTDOOR	P. 538



info@leman-sa.com



GUIDE DE CHOIX

P. 6

INFOS TECHNIQUES

P. 8

-  ASPHALTE P. 9
-  MAÇONNERIE P. 11
-  CARRELAGE P. 23
-  MÉTAL P. 27
-  MULTI-MATÉRIAUX P. 28
-  PIERRE/TUILE P. 30

EXPERT  pour les travaux spécialisés et de haute technicité.

CLASSIC  pour les travaux courants et polyvalents.



GUIDE DE CHOIX

- Utilisation optimale
- Utilisation adaptée
- Utilisation possible

Gamme	Page	Qualité	Applications	Ø (mm)	Asphalte	Béton frais	Béton armé	Béton	Brique, Parpaing	Mortier de jointement
DIA.00120	9	EXPERT	Tronçonnage	300 à 450				
DIA.00220	9	EXPERT	Tronçonnage	230 à 400				
DIA.00410	10	EXPERT	Tronçonnage	115 à 450	
DIA.00310	10	CLASSIC	Tronçonnage	300 à 400	
DIA.00745	11	EXPERT	Tronçonnage	230			
DIA.00815	11	EXPERT	Tronçonnage	230			
DIA.00740	12	EXPERT	Tronçonnage	115 à 450			
DIA.00720	12	EXPERT	Tronçonnage	115 à 400			
DIA.XL00710	13	EXPERT	Tronçonnage	115 à 125			
DIA.00055	13	CLASSIC	Tronçonnage	115 à 230			
DIA.00770	14	CLASSIC	Tronçonnage	115 à 350			
DIA.00077	14	CLASSIC	Tronçonnage	115 à 230				
DIA.00780	15	EXPERT	Rainurage	125 à 150			
DIA.01250	15	EXPERT	Déjointoyage	125				
DIA.00012	16	CLASSIC	Déjointoyage	115 à 125				
DIA.02500	17	EXPERT	Ponçage	125				
DIA.01500	17	EXPERT	Ponçage	125 à 180				
DIA.01100	18	EXPERT	Ponçage	100 à 180				
DIA.00097	18	CLASSIC	Ponçage	100 à 180				
DIA.05200	19	EXPERT	Perçage	32 à 250			
DIA.00561	21	EXPERT	Perçage	35 à 82			
DIA.00052	22	CLASSIC	Perçage	32 à 127				
DIA.00995	23	EXPERT	Tronçonnage	115 à 125						
DIA.00980	23	EXPERT	Tronçonnage	115 à 230						
DIA.00910	24	EXPERT	Tronçonnage	115 à 350						
DIA.XL00910	24	EXPERT	Tronçonnage	115 à 125						
DIA.00930	25	CLASSIC	Tronçonnage	115 à 230						
DIA.00960	25	EXPERT	Tronçonnage	115 à 250						
DIA.00920	26	EXPERT	Tronçonnage	115 à 350						
DIA.00090	26	CLASSIC	Tronçonnage	115 à 230						
DIA.00950	27	EXPERT	Tronçonnage	115 à 350						
DIA.00970	27	EXPERT	Tronço / Ponçage	115 à 230						
DIA.00900	28	EXPERT	Tronçonnage	230 à 350						
DIA.00095	28	CLASSIC	Tronçonnage	125					..	
DIA.01750	29	EXPERT	Ponçage	125						
DIA.01400	29	EXPERT	Ponçage	125						
DIA.01800	30	CLASSIC	Ponçage	115 à 180				.	..	
DIA.00730	30	EXPERT	Tronçonnage	115 à 400			
DIA.00630	31	EXPERT	Tronçonnage	125 à 160			
DIA.00635	31	EXPERT	Tronçonnage	115 à 180				
DIA.00850	32	EXPERT	Tronço / Ponçage	115 à 230					.	
DIA.00895	32	EXPERT	Tronçonnage	115 à 230			
DIA.00890	33	EXPERT	Tronçonnage	115 à 300			
DIA.00088	33	CLASSIC	Tronçonnage	115 à 230					..	

OUTILS DIAMANTÉS

 ASPHALTE

 CARRELAGE

 MULTI-MATÉRIAUX

 MAÇONNERIE

 MÉTAL

 PIERRE/TUILE

	Granit, Pierre naturelle	Marbre	Grès cérame	Carrelage, Faïence	Tuile	Tuile Ste Foy	Acier	Bois	PVC	Epoxy	Colle	Peinture, Vernis
	..						.					
	.											
					
	..											
					
	..											
	..						.					
	..											
	.											
	..											

	..											
								
								
								
								
								
									
				...								
									
			
										
			
									
							
							
	..	.										
	..	.										
									
			
						
						
						

NORME ET CERTIFICATION

La réglementation en vigueur impose le respect de normes et de marquages sur les disques.

Nos produits sont conformes aux normes en vigueur et font l'objet de certifications volontaires pour garantir leurs caractéristiques techniques et la sécurité des utilisateurs.

Norme Européenne EN 13236

EN13236

Décret Français

n°2003-158 / décret Raffarin



CONSEILS D'UTILISATION

- Porter des équipements de protection individuels (lunettes, masque, gants, casque antibruit).
- Examiner tous les produits avant utilisation pour déceler des dommages ou défauts éventuels.
- Toujours utiliser un carter de protection.
- S'assurer que l'alésage du disque a le même diamètre que celui de la broche de la machine.
- Toujours monter le disque dans le sens de rotation indiqué par la flèche gravée sur le disque.
- Toujours faire tourner le disque à vide quelques secondes avant son utilisation.
- Ne pas forcer lors de la coupe, le poids de la machine est suffisant.
- S'assurer que la pièce à travailler est bien positionnée et correctement maintenue.
- Faire en sorte que le disque ne chauffe pas et couper avec des intervalles de pause pour le refroidissement.
- Couper toujours en ligne droite, n'effectuez jamais de coupe en courbe, sauf disque spécifique.
- Ne jamais poncer avec un disque qui n'est pas prévu pour ce travail.
- Il est important d'utiliser le disque adapté à la tâche et de respecter la vitesse maximale autorisée.

ASPHALTE



DIA.00120
DISQUE DIAMANT ASPHALTE

HAUT RENDEMENT ET LONGÉVITÉ

- Disque à segments soudés laser.
- Segments inclinés pour la protection contre l'usure de la tôle.
- Coupe précise et rapide.
- Forte concentration de grains diamant.

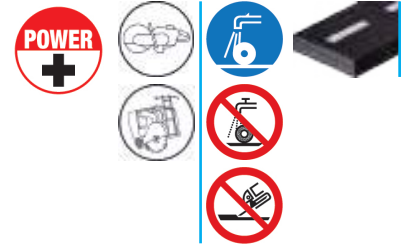

EN13236

ASPHALTE, MATÉRIAUX ABRASIFS, BÉTON FRAIS

Ø	Ø	Ø	Ø	Ø	Ø	Ø	REF	Ø	€
300	20	3,0	18	37	15,0	6400	120301	3661589003652	193,10
300	25,4/22,23	3,0	18	37	15,0	6400	120305	3661589003676	193,10
350	20	3,2	21	37	15,0	5500	120351	3661589003683	245,84
350	25,4	3,2	21	37	15,0	5500	120355	3661589003690	245,84
400	25,4	3,4	24	38	15,0	4800	120405	3661589003706	288,16
450	25,4	3,6	28	37	15,0	4250	120455	3661589003713	336,19



DIA.00220
DISQUE DIAMANT ASPHALTE

BON RENDEMENT

- Disque à segments soudés laser.
- Segments inclinés pour la protection contre l'usure de la tôle.
- Bonne qualité de coupe et durée de vie.

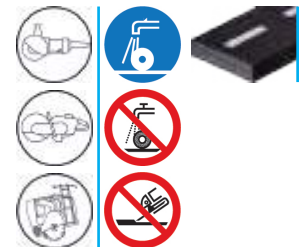

EN13236

ASPHALTE, MATÉRIAUX ABRASIFS, BÉTON FRAIS

Ø	Ø	Ø	Ø	Ø	Ø	Ø	REF	Ø	€
230	22,23	2,6	16	38	10,0	6650	220230	3661589031013	102,02
300	20	3,0	18	38	10,0	6400	220301	3661589003805	147,79
300	25,4/22,23	3,0	18	38	10,0	6400	220305	3661589003829	147,79
350	20	3,2	21	39	10,0	5500	220351	3661589003836	179,68
350	25,4	3,2	21	39	10,0	5500	220355	3661589003843	179,68
400	25,4	3,4	24	39	10,0	4800	220405	3661589003850	233,91

ASPHALTE



DIA.00410

DISQUE DIAMANT ASPHALTE, BÉTON ARMÉ

PERFORMANCE ET POLYVALENCE

- Disque à segments turbo monobloc alternés, soudés laser.
- Tôle perforée, segments de protection.
- Grande vitesse de coupe et longévité.
- Performant dans de nombreux matériaux.

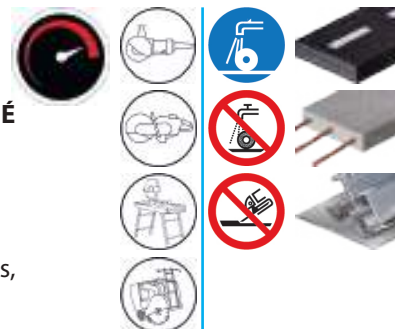

EN13236

ASPHALTE, MATÉRIAUX ABRASIFS, BÉTON ARMÉ, PIERRE NATURELLE, GRANIT, ACIER

Ø	Ø	Ø	Ø	Ø	Ø	Ø	REF	REF	€
115	22,23	2,3	8	32	12,0	13300	410115	3661589004536	73,54
125	22,23	2,3	9	32	12,0	12250	410125	3661589004543	78,80
230	22,23	2,6	16	38	12,0	6650	410230	3661589004550	152,34
300	20	3,0	20	39	12,0	6400	410301	3661589003935	185,33
300	25,4/22,23	3,0	20	39	12,0	6400	410305	3661589003959	185,33
350	20	3,2	24	38	12,0	5500	410351	3661589003966	210,71
350	25,4	3,2	24	38	12,0	5500	410355	3661589003973	210,71
400	20	3,5	28	38	12,0	4800	410401	3661589003980	277,99
400	25,4	3,5	28	38	12,0	4800	410405	3661589003997	277,99
450	25,4	4,0	32	38	12,0	4250	410455	3661589004000	306,40



DIA.00310

DISQUE DIAMANT ASPHALTE, BÉTON ARMÉ

IDÉAL POUR LE BTP

- Disque à segments soudés laser.
- Tôle perforée, segments de protection.
- Bonne vitesse de coupe et longévité.
- Performant dans de nombreux matériaux.

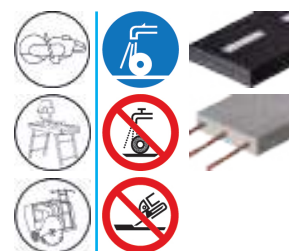

EN13236

ASPHALTE, MATÉRIAUX ABRASIFS, BÉTON ARMÉ, PIERRE NATURELLE, GRANIT

Ø	Ø	Ø	Ø	Ø	Ø	Ø	REF	REF	€
300	20	3,2	16	50	10,0	6400	310301	3661589003867	137,10
300	25,4/22,23	3,2	16	50	10,0	6400	310305	3661589003881	137,10
350	20	3,2	19	50	10,0	5500	310351	3661589003898	160,74
350	25,4	3,2	19	50	10,0	5500	310355	3661589003904	160,74
400	25,4	3,2	22	50	10,0	4800	310405	3661589003911	226,93

MAÇONNERIE



DIA.00745

DISQUE DIAMANT 3D BÉTON ARMÉ, ACIER

HAUT RENDEMENT ET LONGÉVITÉ

- Disque segments courts, soudés laser.
- Technologie 3D : répartition homogène des grains diamant.
- Très grande vitesse de coupe et longévité.
- Grande régularité de coupe : le disque coupe aussi bien en début qu'en fin de vie.



EN13236

BÉTON ARMÉ, BÉTON, PARPAING, BRIQUE, PIERRE NATURELLE, GRANIT, ACIER

							REF		€
230	22,23	2,6	28	20	12,0	6650	745230	3661589099440	178,00



DIA.00815

DISQUE DIAMANT SILENCIEUX BÉTON ARMÉ

SILENCIEUX ET CONFORTABLE

- Disque segments turbo, soudés laser.
- Tôle sandwich silencieuse.
- Réduction du bruit et des vibrations
- Grand confort d'utilisation et impact sonore réduit.
- Très grande vitesse de coupe et longévité.



EN13236

BÉTON ARMÉ, BÉTON, PARPAING, BRIQUE, PIERRE NATURELLE, GRANIT

							REF		€
230	22,23	2,6	15	38	15,0	6650	815230	3661589039040	167,00

MAÇONNERIE



DIA.00740

DISQUE DIAMANT BÉTON ARMÉ

RAPIDITÉ ET RÉGULARITÉ

- Disque segments turbo, soudés laser.
- Tôle ventilée perforée pour un meilleur refroidissement.
- Segments profilés pour réduire les frottements.
- Très grande vitesse de coupe et longévité.
- Forte concentration de grains diamant.

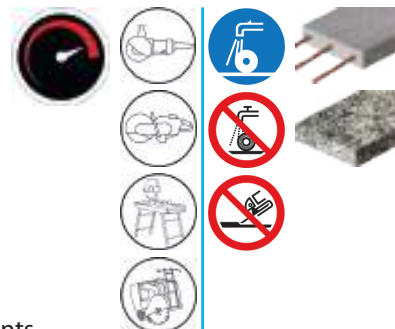

BÉTON ARMÉ, BÉTON, PARPAING, BRIQUE, PIERRE NATURELLE, GRANIT

EN13236

Ø	Ø	Ø	Ø	Ø	Ø	Ø	REF	Ø	€
115	22,23	2,4	8	32	13,0	13300	740115	3661589076403	73,54
125	22,23	2,4	9	32	13,0	12250	740125	3661589076410	78,80
230	22,23	2,6	15	40	13,0	6650	740230	3661589076427	152,34
300	20	3,0	20	40	13,0	6400	740301	3661589076434	205,92
300	25,4/22,23	3,0	20	40	13,0	6400	740305	3661589076441	205,92
350	20	3,2	24	40	13,0	5500	740351	3661589076458	229,03
350	25,4	3,2	24	40	13,0	5500	740355	3661589076465	229,03
400	25,4	3,5	28	40	13,0	4800	740405	3661589076472	304,46
450	25,4	3,5	30	40	13,0	4250	740455	3661589076489	380,32



DIA.00720

DISQUE DIAMANT BÉTON ARMÉ, ACIER

BON RENDEMENT

- Disque à segments soudés laser.
- Tôle ventilée perforée pour un meilleur refroidissement.
- Bonne vitesse de coupe et longévité.
- Monté sur flasque Alu M14 ou Al.22,23.



BÉTON ARMÉ, BÉTON, PARPAING, BRIQUE, PIERRE NATURELLE, GRANIT, ACIER

EN13236

Ø	Ø	Ø	Ø	Ø	Ø	Ø	REF	Ø	€
115	22,23	2,4	9	30	10,0	13300	720115	3661589004567	68,92
125	22,23	2,4	10	30	10,0	12250	720125	3661589004574	73,54
230	22,23	2,6	16	38	10,0	6650	720230	3661589004581	142,68
230	M14	2,6	16	38	10,0	6650	720236	3661589081179	149,68
300	20	3,0	21	40	10,0	6400	720301	3661589004062	178,71
300	25,4/22,23	3,0	21	40	10,0	6400	720305	3661589004086	178,71
350	20	3,2	24	40	10,0	5500	720351	3661589004093	196,67
350	25,4	3,2	24	40	10,0	5500	720355	3661589004109	196,67
400	25,4	3,2	27	40	10,0	4800	720405	3661589004116	272,37

MAÇONNERIE



DIA.XL00710

DISQUE DIAMANT BÉTON, BÉTON ARMÉ

SYSTÈME RAPIDE XLOCK



- Système X-LOCK pour un changement rapide et facile sans clé.
- Disque à segments soudés laser.
- Bonne vitesse de coupe et longévité.



EN13236

BÉTON ARMÉ, BÉTON, PARPAING, BRIQUE, PIERRE NATURELLE, GRANIT

Ø	Ø	Ø	Ø	Ø	Ø	Ø	REF	Ø	€
115	XLOCK	2,4	9	35	10,0	13300	XL710115	3661589101297	60,10
125	XLOCK	2,4	10	35	10,0	12250	XL710125	3661589101303	62,00



DIA.00055

DISQUE DIAMANT BÉTON ARMÉ, ACIER

PRÉCISION



- Disque à segments soudés laser.
- Tôle ventilée perforée pour un meilleur refroidissement.
- Tôle avec flasque renforcée.
- Coupe plus précise et sans vibration.



EN13236

BÉTON ARMÉ, BÉTON, PARPAING, BRIQUE, PIERRE NATURELLE, GRANIT, ACIER

Ø	Ø	Ø	Ø	Ø	Ø	Ø	REF	Ø	€
115	22,23	2,0	8	31	10,0	13300	55115	3510780551151	57,22
125	22,23	2,0	9	31	10,0	12250	55125	3510780551250	59,72
230	22,23	2,5	16	38	10,0	6650	55230	3510780552301	113,26

MAÇONNERIE



DIA.00770

DISQUE DIAMANT BÉTON, BÉTON ARMÉ

RAPIDE ET EFFICACE

- Disque segments turbo frittés.
- Tôle ventilée perforée pour un meilleur refroidissement.
- Grande vitesse de coupe.
- Excellent rapport qualité/prix.



BÉTON ARMÉ, BÉTON, PARPAING, BRIQUE, PIERRE NATURELLE, GRANIT

EN13236

Ø	Ø	Ø	Ø	Ø	Ø	Ø	REF	Ø	€
115	22,23	2,0	9	32	12,0	13300	770115	3661589004628	34,67
125	22,23	2,0	10	32	12,0	12250	770125	3661589004635	40,45
230	22,23	2,6	18	34	12,0	6650	770230	3661589004666	83,21
300	20	3,0	22	40	12,0	6400	770301	3661589084538	111,68
300	25,4/22,23	3,0	22	40	12,0	6400	770305	3661589084545	111,68
350	20	3,2	24	40	12,0	5500	770351	3661589084552	144,98
350	25,4	3,2	24	40	12,0	5500	770355	3661589084569	144,98



DIA.00077

DISQUE DIAMANT MAÇONNERIE

IDÉAL POUR LES TRAVAUX DE MAÇONNERIE

- Disque segments turbo frittés.
- Tôle ventilée perforée pour un meilleur refroidissement.
- Excellent rapport qualité/prix.

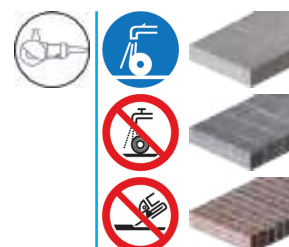

BÉTON, PARPAING, BRIQUE

EN13236

Ø	Ø	Ø	Ø	Ø	Ø	Ø	REF	Ø	€
115	22,23	2,4	9	32	10,0	13300	771154	3510780116060	21,96
125	22,23	2,0	9	31	10,0	12250	771254	3510780116077	27,74
230	22,23	2,8	18	33	10,0	6650	772304	3510780116084	60,10

MAÇONNERIE



DIA.00780

DISQUE DIAMANT A RAINURER BÉTON

SPÉCIAL RAINUREUSE

- Disque à segments soudés laser.
- Exécution de travail rapide.
- Bonne vitesse de coupe et longévité.

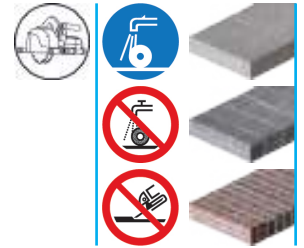

EN13236

BÉTON, PARPAING, BRIQUE									
Ø	Ø	Ø	Ø	Ø	Ø	Ø	REF	Ø	€
125	22,23	2,2	10	32	12,0	12250	780125	3661589004840	64,72
140	22,23	2,4	11	42	12,0	10930	780140	3661589004857	84,36
150	22,23	2,4	12	42	12,0	10200	780150	3661589004864	91,30



DIA.01250

DISQUE DIAMANT À DÉJOINTOYER MORTIER

SPÉCIAL JOINTS DURS ET TENDRES

- Disque à segments alternés, soudés laser.
- Élimination rapide et efficace des joints de mortier et ciment.
- Protection de la tôle par des pastilles carbure.
- Meilleur dégagement des matériaux.

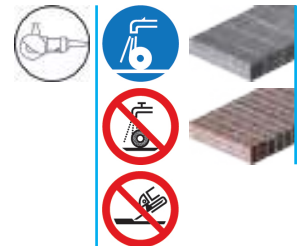

EN13236

PARPAING, BRIQUE, MORTIER CIMENT									
Ø	Ø	Ø	Ø	Ø	Ø	Ø	REF	Ø	€
125	22,23	6,5	10	32	7,0	12250	1250125	3661589004826	156,02

MAÇONNERIE



DIA.00012

DISQUE DIAMANT À DÉJOINTOYER MORTIER

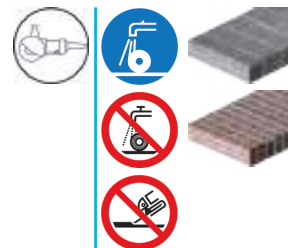

IDÉAL POUR RETIRER LES VIEUX JOINTS

- Disque segments frittés.
- Élimination rapide et efficace des joints de mortier et ciment.
- Disponible en deux épaisseurs différentes.

PARPAING, BRIQUE, MORTIER CIMENT

EN13236

Ø	Ø	Ø	Ø	Ø	Ø	Ø	REF	Ø	€
115	22,23	6,0	8	38	7,0	13300	1260115	3661589077868	54,63
115	22,23	8,0	8	38	7,0	13300	1280115	3661589077875	65,14
125	22,23	6,0	9	37	7,0	12250	1260125	3661589077899	74,59
125	22,23	8,0	9	37	7,0	12250	1280125	3661589077905	91,56

CLASSIC



DIA.00022

FRAISE À DÉJOINTOYER CARBURE MORTIER

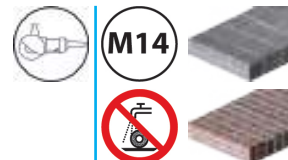

IDÉAL POUR JOINTS ÉTROITS

- Concrétion carbure de tungstène.
- Élimination rapide et efficace des joints de mortier et ciment.
- Toujours percer un trou avant utilisation.

PARPAING, BRIQUE, MORTIER CIMENT

Ø	LU	Ø	REF	Ø	€
6	50	M14	22.006	3661589077912	23,11
8	50	M14	22.008	3661589077929	26,48
10	50	M14	22.010	3661589077936	27,74

MAÇONNERIE



DIA.02500
PLATEAU DIAMANTÉ BÉTON

USAGE INTENSIF

- Plateau en forme de flèche très agressifs.
- Grande vitesse de travail.
- Forte concentration de grains diamant.
- Adapté aux surfaces difficiles à poncer.
- Ventilation optimale et dégagement des poussières.

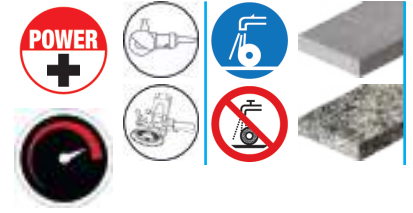

BÉTON, GRANIT, PIERRE NATURELLE



EN13236

Ø	Ø	Ø	Ø	Ø	Ø	REF	Ø	€
125	22,23	7,0	8	5,0	12250	2500125	3661589072023	148,78



DIA.01500
PLATEAU DIAMANTÉ BÉTON

LÉGER ET RAPIDE

- Plateau à segments virgules brasés.
- Légèreté et confort d'utilisation.
- Surfaçage ultra-rapide et régulier.
- Ventilation optimale et dégagement des poussières.



BÉTON, GRANIT, PIERRE NATURELLE



EN13236

Ø	Ø	Ø	Ø	Ø	Ø	REF	Ø	€	
125	22,23	7,5	8	18/30	6,5	12250	1500125	3661589005090	141,21
180	22,23	7,5	12	17/34	6,5	8500	1500178	3661589005113	180,29

MAÇONNERIE

EXPERT



DIA.01100
PLATEAU DIAMANTÉ BÉTON

HAUT RENDEMENT ET LONGÉVITÉ

- Plateau à double pistes.
- Grande longévité et endurance.
- Travail rapide et régulier.
- Trous d'évacuation des poussières.



EN13236

BÉTON, GRANIT, PIERRE NATURELLE

Ø	Ø	Ø	Ø	Ø	Ø	Ø	REF	Ø	€
100	22,23	7,0	8	30/20	5,0	15300	1100100	3661589005052	75,12
125	22,23	7,0	10	30/24	5,0	12250	1100125	3661589005069	101,70
180	22,23	7,0	12	35/28	5,0	8500	1100178	3661589005076	127,12

CLASSIC



DIA.00097
PLATEAU DIAMANTÉ BÉTON

BON RENDEMENT

- Plateau à double pistes.
- Bonne vitesse de travail et longévité.
- Trous d'évacuation des poussières.
- Excellent rapport qualité/prix.

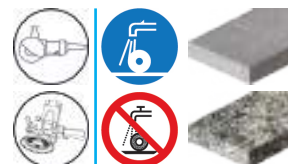

BÉTON, GRANIT, PIERRE NATURELLE

EN13236

Ø	Ø	Ø	Ø	Ø	Ø	Ø	REF	Ø	€
100	22,23	7,0	8	30/22	5,0	15300	971	3510780100014	60,10
115	22,23	7,0	9	30/22	5,0	13300	972	3510780100021	60,10
125	22,23	7,0	10	31/24	5,0	12250	974	3510780125024	74,59
180	22,23	7,0	12	40/30	5,0	8500	976	3510780180023	96,66

MAÇONNERIE

EXPERT



DIA.05200

COURONNE DIAMANTÉE BÉTON ARMÉ

USAGE INTENSIF

- Couronne à segments turbo, soudés laser.
- Raccord 1" 1/4 femelle.
- Excellente perforation et longévité.

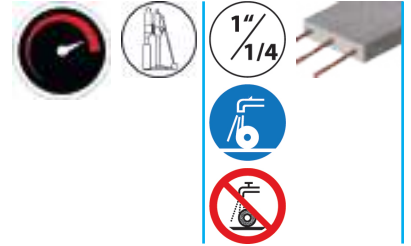

BÉTON, BÉTON ARMÉ

						REF		€
32	410	3,5	3	16	10,0	5200032	3661589039583	87,83
42	410	3,5	4	20	10,0	5200042	3661589039590	91,30
52	410	3,5	5	24	10,0	5200052	3661589005403	93,62
56	410	3,5	5	24	10,0	5200056	3661589005410	110,95
62	410	3,5	6	24	10,0	5200062	3661589048844	114,41
66	410	3,5	6	24	10,0	5200066	3661589046628	115,57
68	410	3,5	6	24	10,0	5200068	3661589005434	127,12
70	410	3,5	6	24	10,0	5200072	3661589048851	134,06
82	410	3,5	8	24	10,0	5200082	3661589005458	153,70
92	410	3,5	8	24	10,0	5200092	3661589031099	186,07
102	410	4,0	9	24	10,0	5200102	3661589005472	195,31
108	410	4,0	9	24	10,0	5200108	3661589031105	204,56
112	410	4,0	10	24	10,0	5200112	3661589005496	221,89
122	410	4,0	11	24	10,0	5200122	3661589005502	239,23
127	410	4,0	11	24	10,0	5200127	3661589031112	250,79
132	410	4,0	11	24	10,0	5200132	3661589005519	255,41
152	410	4,0	12	24	10,0	5200152	3661589005526	299,32
162	410	4,0	13	24	10,0	5200162	3661589005540	333,99
167	410	4,0	13	24	10,0	5200167	3661589031129	346,70
182	410	4,8	14	24	10,0	5200182	3661589031136	374,44
202	410	4,8	15	24	10,0	5200200	3661589005571	410,26
250	410	4,8	18	24	10,0	5200250	3661589005595	532,77

MAÇONNERIE



DIA.06100.5

ADAPTATEURS

	REF		€
1/2" Gaz mâle / 1"1/4 mâle	610052	3661589000569	37,83
1/2" Gaz femelle / 1"1/4 femelle	610054	3661589000552	37,83



DIA.06100.7



ADAPTATEURS

	REF		€
Type DDBI 1"1/4 mâle / 1/2" femelle	610070	3661589000545	148,22
Type DDBU 1"1/4 mâle / 1/2" femelle	610071	3661589031143	148,22



DIA.06300



RALLONGE POUR COURONNE

		REF		€
1"1/4 mâle / femelle	300	630083	3661589000620	72,81
1"1/4 mâle / femelle	400	630084	3661589000637	75,12
1"1/4 mâle / femelle	500	630085	3661589000644	78,59



DIA.06400

RALLONGE POUR COURONNE

		REF		€
Raccord 1/2" gaz mâle / femelle	400	640094	3661589006080	75,12



DIA.05100



BAGUE ANTI-BLOCAGE POUR COURONNE

			REF		€
40	32	2,0	5100432	3661589025579	10,40



DIA.05100.2

BAGUES RÉDUCTION

		REF		€
25,4/20	2,2	5100420	3661589005151	3,47
25,4/22,23	2,2	5100422	3661589005168	3,47
22,23/20	2,2	5100220	3661589005175	3,47



DIA.05100.9

BAGUES RÉDUCTION

		REF		€
25,4/20	9,0	5100429	3661589005182	5,78

MAÇONNERIE



DIA.00561
COURONNE DIAMANTÉE M14 BÉTON

RAPIDE ET CONFORTABLE SUR MEULEUSE

- Couronne à segments turbo, soudés laser.
- Perçage facile, rapide et sans effort.
- Protection latérale diamantée.
- Risques de blocage limités.
- Hautes performances.



BÉTON, PARPAING, BRIQUE

Ø	LU	Ø	Ø	Ø	REF	Ø	€
35	80	M14	4	10,0	5614035	3661589092120	75,20
50	80	M14	4	10,0	5614050	3661589092137	115,38
68	80	M14	4	10,0	5614068	3661589092144	134,95
82	80	M14	4	10,0	5614082	3661589092151	153,50

CLASSIC



DIA.VAL52
COFFRET DE 5 COURONNES DIAMANTÉES
MATÉRIAUX DE CONSTRUCTION

IDÉAL DANS LES MATÉRIAUX DE CONSTRUCTION

- Couronnes à segments turbo, soudés laser.
- Perçage rapide et net.
- Perçage en rotation uniquement.



PARPAING, BRIQUE, BÉTON CELLULAIRE

- 1 clé plate de 24 mm pour démontage couronnes.
- 1 Prolongation 100 mm - Hexagonal.
- 1 Prolongation 240 mm - Hexagonal.
- 1 Prolongation 100 mm - SDS plus
- 1 Prolongation 240 mm - SDS plus
- 1 Foret de centrage 10 x 220 mm.

Ø	LU	REF	Ø	€
32/52/68/82/102	170	VAL5200.05	3661589039033	448,82

MAÇONNERIE

CLASSIC



DIA.00052

COURONNE DIAMANTÉE MATÉRIAUX DE CONSTRUCTION

IDÉAL DANS LES MATÉRIAUX DE CONSTRUCTION

- Couronne à segments turbo, soudés laser.
- Perçage rapide et net.
- Perçage en rotation uniquement.

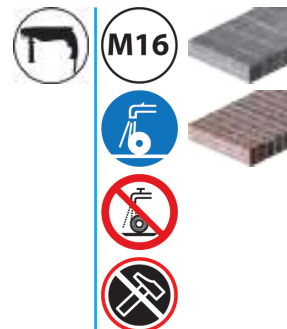

PARPAING, BRIQUE, BÉTON CELLULAIRE

Ø	LU					REF		€
32	170	M16	3,5	16	10,0	5216032	3661589039538	69,75
52	170	M16	3,5	20	10,0	5216052	3661589039545	83,50
68	170	M16	3,5	24	10,0	5216068	3661589039552	96,27
82	170	M16	3,5	24	10,0	5216082	3661589039569	105,12
102	170	M16	3,5	24	10,0	5216102	3661589039576	112,97
127	170	M16	3,5	24	10,0	5216127	3661589062840	141,82

CLASSIC



DIA.00520

KIT ADAPTATEUR POUR PERFORATEUR SDS+

	REF		€
100	520010	3661589062857	24,28
240	520011	3661589066220	30,05

CLASSIC



DIA.00521

FORET CENTRAGE 10X220MM

	REF		€
220	520001	3661589039484	8,10

CARRELAGE



EN13236



DIA.00995

DISQUE DIAMANT GRÈS CÉRAME

HAUT RENDEMENT ET LONGÉVITÉ

- Disque à jante continue cannelée extra-fin.
- Hautes performances dans les carreaux les plus durs.
- Flasque renforcée pour une coupe plus précise et sans vibration.
- Très grande vitesse de coupe et longévité.
- Excellente finition.



CARRELAGE, GRÈS CÉRAME, PIERRE NATURELLE, GRANIT, MARBRE

					REF		€
115	22,23	1,4	11,0	13300	995115	3661589099457	54,50
125	22,23	1,4	11,0	12250	995125	3661589099464	60,96



EN13236



DIA.00980

DISQUE DIAMANT GRÈS CÉRAME

RAPIDITÉ ET PRÉCISION

- Disque à jante continue en croisillons extra-fin.
- Flasque renforcée pour une coupe plus précise et sans vibration.
- Grande vitesse de coupe et longévité.
- Coupe nette et sans éclat.



CARRELAGE, GRÈS CÉRAME, PIERRE NATURELLE, GRANIT, MARBRE

					REF		€
115	22,23	1,4	10,0	13300	980115	3661589056757	52,01
125	22,23	1,4	10,0	12250	980125	3661589056764	58,31
230	22,23	1,6	10,0	6650	980230	3661589078162	148,13

CARRELAGE



EN13236



DIA.00910

DISQUE DIAMANT GRÈS CÉRAME

PERFORMANCE ET RAPIDITÉ

- Disque à jante continue cannelée extra-fin.
- Haut rendement et durée de vie.
- Coupe propre et rapide.



CARRELAGE, GRÈS CÉRAME, PIERRE NATURELLE, GRANIT, MARBRE

Ø	Ø	Ø	Ø	Ø	REF	REF	€
115	22,23	1,4	7,0	13300	910115	3661589004949	48,33
125	22,23	1,4	7,0	12250	910125	3661589004956	54,01
180	30/25,4/22,23	1,4	7,0	8500	910180	3661589004420	80,78
200	30/25,4/22,23	1,6	7,0	7650	910200	3661589004437	96,90
230	30/25,4/22,23	1,6	7,0	6650	910230	3661589004444	111,26
250	30/25,4	1,6	7,0	6100	910250	3661589004451	147,08
300	30/25,4	2,0	7,0	6400	910300	3661589004468	218,42
350	30/25,4	2,0	7,0	5500	910350	3661589004475	284,17



EN13236



DIA.XL00910

DISQUE DIAMANT GRÈS CÉRAME

SYSTÈME RAPIDE XLOCK

- Système X-LOCK pour un changement rapide et facile sans clé.
- Disque à jante continue cannelée extra-fin.
- Flasque renforcée pour une coupe plus précise et sans vibration.
- Haut rendement et durée de vie.



CARRELAGE, GRÈS CÉRAME, PIERRE NATURELLE, GRANIT, MARBRE

Ø	Ø	Ø	Ø	Ø	REF	REF	€
115	XLOCK	1,4	7,0	13300	XL910115	3661589101426	50,76
125	XLOCK	1,4	7,0	12250	XL910125	3661589101440	56,70

CARRELAGE



DIA.00930

DISQUE DIAMANT GRÈS CÉRAME

BON RENDEMENT ET PRÉCISION

- Disque à jante continue cannelée extra-fin.
- Flasque renforcée pour une coupe plus précise et sans vibration.
- Bonne tenue de coupe et finition.
- Excellent rapport qualité/prix.



EN13236

CARRELAGE, GRÈS CÉRAME, PIERRE NATURELLE, GRANIT, MARBRE

Ø	Ø	Ø	Ø	Ø	REF	REF	€
115	22,23	1,4	8,0	13300	930115	3661589029867	36,77
125	22,23	1,4	8,0	12250	930125	3661589029874	40,97
230	22,23	1,8	8,0	6650	930230	3661589029881	99,81



DIA.00960

DISQUE DIAMANT CARRELAGE

HAUT RENDEMENT ET LONGÉVITÉ

- Disque à jante lisse segmentée.
- Rendement élevé et très bonne durée de vie.
- Finition de haute qualité.
- Forte concentration de grains diamant.
- Privilégier une coupe à eau.

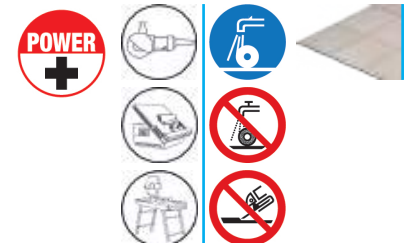

EN13236

FAÏENCE, CARRELAGE, MARBRE

Ø	Ø	Ø	Ø	Ø	REF	REF	€
115	22,23	1,6	7,0	13300	960115	3661589036483	40,45
125	22,23	1,6	7,0	12250	960125	3661589036490	45,07
180	30/25,4/22,23	1,8	10,0	8500	960180	3661589039316	63,04
200	30/25,4/22,23	1,8	10,0	7650	960200	3661589039347	74,59
230	30/25,4/22,23	1,8	10,0	6650	960230	3661589039354	89,30
250	30/25,4	1,8	10,0	6100	960250	3661589039361	107,16

CARRELAGE



EN13236



DIA.00920

DISQUE DIAMANT CARRELAGE

FINITION SANS ÉCLAT

- Disque à jante continue lisse.
- Tôle ventilée perforée pour un meilleur refroidissement.
- Bonne tenue de coupe et finition.



FAÏENCE, CARRELAGE

Ø	Ø	Ø	Ø	Ø	REF	REF	€
115	22,23	1,4	7,0	13300	920115	3661589004963	21,96
125	22,23	1,4	7,0	12250	920125	3661589004970	24,28
180	30/25,4/22,23	1,6	7,0	8500	920180	3661589004994	42,77
200	30/25,4/22,23	1,8	7,0	7650	920200	3661589005007	42,77
230	22,23	1,8	7,0	6650	920230	3661589005014	47,39
300	30/25,4	2,2	7,0	6400	920300	3661589005038	129,22
350	30/25,4	2,2	7,0	5500	920350	3661589005045	161,79



EN13236



DIA.00090

DISQUE DIAMANT CARRELAGE

COUPE NETTE ET PRÉCISE

- Disque à jante continue lisse.
- Bonne tenue de coupe et finition.
- Excellent rapport qualité/prix.



FAÏENCE, CARRELAGE

Ø	Ø	Ø	Ø	Ø	REF	REF	€
115	22,23	1,9	5,0	13300	901154	3510780116152	15,02
125	22,23	1,9	5,0	12250	901254	3510780116169	19,66
180	30/25,4/22,23	2,4	5,0	8500	901804	3510780116237	36,77
230	22,23	2,5	5,0	6650	902304	3510780116176	40,97

MÉTAL



EN13236



DIA.00950 DISQUE DIAMANT MÉTAL

DURABLE ET EFFICACE

- Technologie vacuum brazed.
- Longévité multipliée en comparaison à des abrasifs standards.
- Ultra fin pour des découpes précises et propres.
- Résidus des étincelles, fragments et odeurs limités.

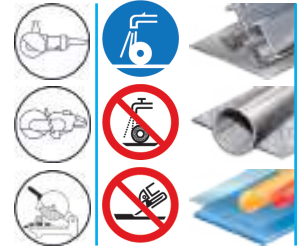

ACIER, ACIER INOXYDABLE, FONTE, MATIÈRES PLASTIQUES, PVC

Ø	Ø	Ø	Ø	Ø	REF	Ø	€
115	22,23	1,8	2,0	13300	950115	3661589053916	40,67
125	22,23	1,8	2,0	12250	950125	3661589053909	45,81
230	22,23	2,4	2,0	6650	950230	3661589053923	84,05
300	20	3,0	2,0	6400	950301	3661589099303	185,66
300	25,4/22,23	3,0	2,0	6400	950305	3661589099310	185,66
350	20	3,2	2,0	5500	950351	3661589099327	218,56
350	25,4	3,2	2,0	5500	950355	3661589099334	218,56



EN13236



DIA.00970 DISQUE DIAMANT COUPE ET PONCE MÉTAL

COUPE, PONCE, ÉBARBE

- Technologie vacuum brazed.
- Longévité multipliée en comparaison à des abrasifs standards.
- Disque réversible pour une durée de vie doublée.
- Résidus des étincelles, fragments et odeurs limités.



ACIER, ACIER INOXYDABLE, FONTE, MATIÈRES PLASTIQUES, PVC

Ø	Ø	Ø	Ø	Ø	REF	Ø	€
115	M14	2,5	30,0	13300	970115	3661589071965	77,33
125	M14	2,7	30,0	12250	970125	3661589071989	91,62
230	M14	3,0	60,0	6650	970230	3661589072016	155,49

MULTI-MATÉRIAUX



DIA.00900

DISQUE CARBURE MULTI-MATÉRIAUX

RÉSISTANT ET POLYVALENT

- Disque à segments au carbure de tungstène.
- Idéal pour les paysagistes, travaux de démolition.
- Très résistant et agressif.
- Réversible, le disque peut être utilisé dans les 2 sens de rotation.
- Performant dans de nombreux matériaux.



BOIS, RACINES ET BRANCHES D'ARBRE, BOIS DE PALETTE, BOIS CLOUTÉ, CONTREPLAQUÉ, AGGLOMÉRÉ, CAOUTCHOUC, FEUTRE BITUMÉ, PVC

EN13236

Ø	Ø	Ø	Ø	Ø	Ø	REF	REF	€
230	22,23	5,0	15	10,0	6650	900230	3661589099341	273,00
300	20	5,0	25	10,0	6400	900301	3661589099358	399,60
350	20	5,0	30	10,0	5500	900351	3661589099365	444,20
350	25,4	5,0	30	10,0	5500	900355	3661589099372	444,20



DIA.00095

DISQUE DIAMANT MULTI-MATÉRIAUX

RAPIDE, RÉSISTANT, EFFICACE

- Technologie vacuum brazed.
- Haute résistance aux températures élevées pendant la coupe.
- Réduction des formations d'étincelles.
- Multi usage pour la coupe de tout type de matériaux.



PARPAING, BRIQUE, BOIS, ACIER, PIERRE NATURELLE, TUILE, CARRELAGE, MATIÈRES PLASTIQUES, PVC

EN13236

Ø	Ø	Ø	Ø	Ø	Ø	REF	REF	€	
125	22,23	2,6	9	38	9,0	12250	951254	3661589088451	31,52

MULTI-MATÉRIAUX

EXPERT



EN13236



DIA.01750

PLATEAU DIAMANTÉ POLYCRISTALLIN

HAUT RENDEMENT ET LONGÉVITÉ

- Segments brasés en diamant polycristallin.
- Enlèvement rapide des colles, vernis, peintures, résines.
- Très résistant et agressif.
- Ventilation optimale et dégagement des poussières.
- Ne pas utiliser s'il y a un risque sur la présence de vis, clous, goujons...



COLLE, PEINTURE, VERNIS, RÉSINE, REVÊTEMENT ÉPOXY

					REF		€
125	22,23	6	4,0	12250	1750125	3661589099433	225,00

EXPERT



EN13236



DIA.01400

PLATEAU DIAMANTÉ ÉPOXY

LÉGER ET SILENCIEUX

- Technologie vacuum brazed.
- Tôle sandwich silencieuse.
- Légèreté et confort d'utilisation.
- Enlèvement des vernis, colles, peintures, matériaux thermoplastiques et de résine epoxy sur béton ou bois.
- Trous d'évacuation des poussières.



COLLE, PEINTURE, VERNIS, RÉSINE, REVÊTEMENT ÉPOXY

			REF		€
125	22,23	12250	1400125	3661589049919	135,96

MULTI-MATÉRIAUX



DIA.01800

PLATEAU CARBURE MULTI-MATÉRIAUX



TRÈS POLYVALENT

- Revêtement carbure de tungstène.
- Bonne vitesse de travail et longévité.
- Tôle bombée.
- Trous d'évacuation des poussières.
- Performant dans de nombreux matériaux.

BÉTON, BOIS, PEINTURE, VERNIS, COLLE, PLÂTRE, CAOUTCHOUC, MATIÈRES PLASTIQUES, PVC

EN13236

Ø	Ø	Ø	REF	REF	€
115	22,23	13300	1800115	3661589049131	36,77
125	22,23	12250	1800125	3661589071774	44,13
180	22,23	8500	1800180	3661589071781	68,29

PIERRE & TUILE



DIA.00730

DISQUE DIAMANT GRANIT, PIERRE NATURELLE

RAPIDITÉ ET RÉGULARITÉ



- Disque segments turbo, soudés laser.
- Segments courts pour un confort de travail et une meilleure pénétration.
- Très grande vitesse de coupe et longévité.
- Forte concentration de grains diamant.

BÉTON, PARPAING, BRIQUE, PIERRE NATURELLE, GRANIT

EN13236

Ø	Ø	Ø	Ø	Ø	Ø	Ø	REF	REF	€
115	22,23	2,3	8	32	12,0	13300	730115	3661589077745	74,42
125	22,23	2,3	9	32	12,0	12250	730125	3661589077752	79,28
230	22,23	2,6	28	20	12,0	6650	730230	3661589077769	154,06
300	20	3,0	36	20	12,0	6400	730301	3661589077776	218,86
300	25,4/22,23	3,0	36	20	12,0	6400	730305	3661589077783	218,86
350	20	3,2	42	20	12,0	5500	730351	3661589077790	279,17
350	25,4	3,2	42	20	12,0	5500	730355	3661589077806	279,17
400	25,4	3,5	48	20	12,0	4800	730405	3661589077813	344,90

PIERRE & TUILE



DIA.00630
DISQUE DIAMANT GRANIT, QUARTZ

SPÉCIAL QUARTZ

- Disque segments turbo, soudés laser.
- Pour meuleuse et scie plongeante.
- Idéal pour la découpe de plan de travail.



EN13236

BÉTON, GRANIT, PIERRE NATURELLE, QUARTZ							REF		€
Ø	Ø	Ø	Ø	Ø	Ø	Ø			
125	22,23	2,6	9	32	12,0	12250	630125	3661589084804	65,67
160	20	2,6	12	32	12,0	9550	630160	3661589084811	123,97



DIA.00635
DISQUE DIAMANT CONCAVE GRANIT, BÉTON

SPÉCIAL COUPE EN COURBE

- Disque à jante continue cannelée.
- Segments de protection.
- Spécialement adapté pour les coupes en courbe.
- Idéal pour les créations décoratives sur terrasse.
- Confort de travail et sans risque d'endommager le disque.



EN13236

BÉTON, PIERRE NATURELLE, GRANIT							REF		€
Ø	Ø	Ø	Ø	Ø	Ø	Ø			
125	22,23	2,8	9,0	12250	635125	3661589099389	105,30		
180	22,23	3,0	9,0	8500	635180	3661589099396	168,05		

PIERRE & TUILE



EN13236



DIA.00850

**DISQUE DIAMANT COUPE ET PONCE
PIERRE NATURELLE**

TRÈS POLYVALENT

- Disque monté sur flasque alu M14, avec 1 face diamantée par électrolyse.
- Pour ajuster, biseauter, chanfreiner et poncer.
- Bonne vitesse de coupe et longévité.



M14



**PARPAING, BRIQUE, PIERRE NATURELLE, GRANIT, MARBRE, TUILE, CARRELAGE,
MATIÈRES PLASTIQUES, PVC**

					REF		€
115	M14	2,0	3,0	13300	850115	3661589004482	72,49
125	M14	2,5	3,0	12250	850125	3661589004499	78,80
230	M14	2,8	3,0	6650	850230	3661589004505	144,98



EN13236



DIA.00895

DISQUE DIAMANT TUILE, PIERRE

PERFORMANCE ET RAPIDITÉ

- Disque turbo ventilé à jante continue segmentée.
- Coupe nette, propre et précise.
- Très grande vitesse de coupe et longévité.
- Forte concentration de grains diamant.



TUILE, TUILE DE SAINTE FOY, PARPAING, BRIQUE, PIERRE NATURELLE, GRANIT

					REF		€
115	22,23	2,2	9,0	13300	895115	3661589099402	63,00
125	22,23	2,2	9,0	12250	895125	3661589099419	77,76
230	22,23	2,8	9,0	6650	895230	3661589099426	133,00

PIERRE & TUILE



DIA.00890

DISQUE DIAMANT TUILE, PIERRE

SPÉCIAL TUILE

- Disque turbo ventilé à jante continue.
- Précis et polyvalent.
- Haute durée de vie et performance dans les matériaux abrasifs.
- Monté sur flasque Alu M14 ou Al.22,23.



EN13236

TUILE, TUILE DE SAINTE FOY, PARPAING, BRIQUE, PIERRE NATURELLE, GRANIT

Ø	Ø	Ø	Ø	Ø	REF	Ø	€
115	22,23	2,0	9,0	13300	890115	3661589004871	56,84
125	22,23	2,0	9,0	12250	890125	3661589004888	72,49
125	M14	2,0	9,0	12250	890126	3661589031150	83,00
230	22,23	2,6	9,0	6650	890230	3661589004895	106,96
230	M14	2,6	9,0	6650	890236	3661589031167	112,96
300	25,4/22,23/20	3,2	9,0	6400	890300	3661589004901	194,36



DIA.00088

DISQUE DIAMANT TUILE, BRIQUE

BONNE FINITION

- Disque à jante continue cannelée.
- Idéal pour les matériaux de construction fragile.
- Coupe nette, propre et rapide.
- Excellent rapport qualité/prix.

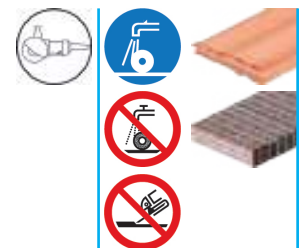

EN13236

TUILE, PARPAING, BRIQUE, PIERRE NATURELLE, GRANIT

Ø	Ø	Ø	Ø	Ø	REF	Ø	€
115	22,23	2,4	7,0	13300	881154	3510780116091	21,96
125	22,23	2,4	7,0	12250	881254	3510780116220	24,28
230	22,23	2,8	7,0	6650	882304	3510780116114	70,50



info@leman-sa.com



GUIDE DE CHOIX

P. 36

INFOS TECHNIQUES

P. 38

 **MÉTAL**

P. 39

 **MULTI-MATÉRIAUX**

P. 48

 **PIERRE**

P. 49

 **PLÂTRE ET MATÉRIAUX TENDRES**

P. 49

EXPERT  pour les travaux spécialisés et de haute technicité.

CLASSIC  pour les travaux courants et polyvalents.



GUIDE DE CHOIX

- Utilisation optimale
- Utilisation adaptée
- Utilisation possible

Gamme	Page	Qualité	Applications	Ø (mm)	Inox	Acier	Aluminium, Métaux non ferreux		
DAT.00195	39	EXPERT	Tronçonnage	115 à 125	•••	•••			
DAT.00185	39	EXPERT	Tronçonnage	115 à 230	•••	•••			
DAT.00179	40	EXPERT	Tronçonnage	125	•••	••			
DAT.01701	40	EXPERT	Tronçonnage	115 à 230	•••	••			
DAT.XL01701	41	EXPERT	Tronçonnage	115 à 125	•••	••			
DAT.00125	41	CLASSIC	Tronçonnage	115 à 230	•••	••			
DAT.00170	42	EXPERT	Tronçonnage	125 à 230	•••	••			
DAT.00129	42	CLASSIC	Tronçonnage / Ebarbage	125	•••	••			
DAT.00120	43	EXPERT	Ebarbage	125 à 230	•••	••			
DAT.01108	45	EXPERT	Tronçonnage	76		•••			
DAT.01601	44	EXPERT	Tronçonnage	115 à 230		•••			
DAT.00121	44	CLASSIC	Tronçonnage	115 à 230		•••			
DAT.00160	45	EXPERT	Tronçonnage	125 à 350		•••			
DAT.XL00160	46	EXPERT	Tronçonnage	115 à 125		•••			
DAT.00123	47	CLASSIC	Tronçonnage	115 à 350		•••			
DAT.01606	47	EXPERT	Ebarbage	115 à 230		•••			
DAT.00126	48	CLASSIC	Ebarbage	115 à 230		•••			
DAT.01104	46	EXPERT	Tronçonnage	300 à 350		•••			
DAT.00169	43	EXPERT	Tronçonnage	125			•••		
DAT.00124	48	CLASSIC	Tronçonnage	125	••	••	••		
DAT.012310	49	CLASSIC	Tronçonnage	115 à 230					
DAT.00017	49	CLASSIC	Tronçonnage	76 à 125					

NORME ET CERTIFICATION

La réglementation en vigueur impose le respect de normes et de marquages sur les disques.

Nos produits sont conformes aux normes en vigueur et font l'objet de certifications volontaires pour garantir leurs caractéristiques techniques et la sécurité des utilisateurs.

Norme Européenne EN 12413
Décret Français
n°2003-158 / décret Raffarin



- 1 Marque
- 2 Dimensions mm
- 3 Vitesse maximale d'utilisation m/s
- 4 Vitesse de rotation maximale admissible tr/min
- 5 Type d'utilisation
- 6 Déclaration de conformité
- 7 Restrictions d'emploi
- 8 Code de traçabilité / Date limite d'utilisation
- 9 Pictogrammes de sécurité
- 10 Spécification
- 11 N° de type ISO/forme

CONSEILS D'UTILISATION

- Porter des équipements de protection individuels (lunettes, masque, gants, casque antibruit).
- Manipuler les disques avec beaucoup de soins, ce sont des produits fragiles.
- Examiner tous les produits avant utilisation pour déceler des dommages ou défauts éventuels.
- Toujours utiliser un carter de protection.
- Toujours faire tourner le disque à vide quelques secondes avant son utilisation.
- Ne pas forcer lors de la coupe, le poids de la machine est suffisant.
- S'assurer que la pièce à travailler est bien positionnée et correctement maintenue.
- Les disques à tronçonner ne doivent jamais être utilisés pour ébarber, sauf disques spécifiques.
- Protéger et disposer convenablement les disques pour éviter dommages et déformations.
- Il est important d'utiliser le disque adapté à la tâche et de respecter la vitesse maximale autorisée.
- Ne jamais utiliser au delà de la date limite d'utilisation indiquée sur le disque.

MÉTAL



DAT.00195

TRONÇONNAGE FIN MOYEU DÉPORTÉ ZIRCONIUM INOX INDUSTRIE

- Destiné à l'industrie pour des travaux intensifs.
- Abrasif zirconium haute performance.
- Technologie anti-humidité pour une conservation des performances et une durée de vie prolongée.
- Idéal pour des coupes précises, rapides et sans bavure dans les tôles et profilés minces.
- Moyeu déporté métallique pour une plus grande rigidité, stabilité et plus de sécurité.



Z



EN12413

ACIER, ACIER INOXYDABLE

Ø	Ø	Ø	Ø	Ø	Ø	REF	Ø	Ø	€
115	22,23	1,0	13300	80	F42	1952110	25	3661589101891	3,32
125	22,23	1,0	12250	80	F42	1952120	25	3661589101907	3,46



DAT.00185

TRONÇONNAGE FIN INOX INDUSTRIE

- Destiné à l'industrie pour des travaux intensifs.
- Abrasif corindon supérieur.
- Technologie anti-humidité pour une conservation des performances et une durée de vie prolongée.
- Idéal pour les tôles et profilés minces.
- Grande vitesse de coupe.



A



EN12413

ACIER, ACIER INOXYDABLE

Ø	Ø	Ø	Ø	Ø	Ø	REF	Ø	Ø	€
115	22,23	1,0	13300	80	F41	1851110	25	3661589101853	3,16
125	22,23	1,0	12250	80	F41	1851120	25	3661589101860	3,30
125	22,23	1,6	12250	80	F41	1851121	25	3661589101877	3,12
230	22,23	2,0	6650	80	F41	1851232	25	3661589101884	6,28

MÉTAL



DAT.00179
TRONÇONNAGE EXTRA FIN INOX

- Idéal pour les coupes de précision dans les tôles minces.
- Durée de vie et performance supérieure.
- Ultra fin, pour une coupe plus nette, plus rapide et plus précise.
- Moins de bavure, moins de poussières et plus de confort.
- Optimisé pour les machines sur batterie.

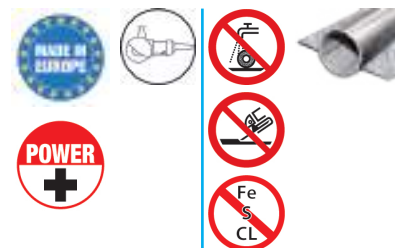

F41

A



EN12413

ACIER, ACIER INOXYDABLE

Ø	Ø	Ø	Ø	Ø	Ø	REF	Ø	Ø	€
125	22,23	0,75	12250	80	F41	1791120	25	3661589088017	3,10



DAT.01701
TRONÇONNAGE FIN INOX

- Idéal pour les tôles et profilés minces.
- Durée de vie maximale.
- Coupe facile et propre.
- Grande vitesse de coupe.

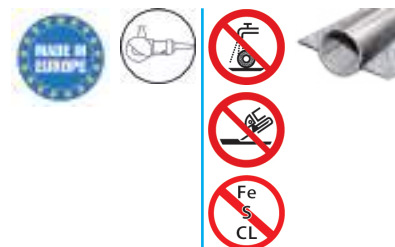

F41

A



EN12413

ACIER, ACIER INOXYDABLE

Ø	Ø	Ø	Ø	Ø	Ø	REF	Ø	Ø	€
115	22,23	1,0	13300	80	F41	1701110	25	3661589002280	2,40
115	22,23	1,6	13300	80	F41	1701111	25	3661589002211	2,30
125	22,23	1,0	12250	80	F41	1701120	25	3661589002297	2,54
125	22,23	1,6	12250	80	F41	1701121	25	3661589002228	2,37
180	22,23	1,6	8500	80	F41	1701181	25	3661589002235	4,73
230	22,23	2,0	6650	80	F41	1701232	25	3661589002242	4,81

DISQUES À TRONÇONNER

MÉTAL



DAT.XL01701 TRONÇONNAGE FIN INOX XLOCK

- Système X-LOCK pour un changement rapide et facile sans clé.
- Idéal pour les tôles et profilés minces.
- Durée de vie maximale.
- Coupe facile et propre.
- Grande vitesse de coupe.



A

ACIER, ACIER INOXYDABLE

EN12413

Ø	Ø	Ø	Ø	Ø	Ø	REF	Ø	Ø	€
115	XLOCK	1,0	13300	80	F41	XL1701110	25	3661589101242	2,66
125	XLOCK	1,0	12250	80	F41	XL1701120	25	3661589101259	2,80
125	XLOCK	1,6	12250	80	F41	XL1701121	25	3661589101266	2,62



DAT.00125 TRONÇONNAGE FIN INOX

- Idéal pour les tôles et profilés minces.
- Longue durée de vie.
- Grande vitesse de coupe.
- Coupe facile et propre.



A

ACIER, ACIER INOXYDABLE

EN12413

Ø	Ø	Ø	Ø	Ø	Ø	REF	Ø	Ø	€
115	22,23	1,0	13300	80	F41	115.10.25	25	3510780115124	2,10
115	22,23	1,6	13300	80	F41	115.16.25	25	3510780115162	1,80
125	22,23	1,0	12250	80	F41	125.10.25	25	3510780125123	2,20
125	22,23	1,6	12250	80	F41	125.16.25	25	3510780125161	1,90
230	22,23	2,0	6650	80	F41	230.20.25	25	3510780230186	4,24

MÉTAL



DAT.00170
TRONÇONNAGE INOX

- Tronçonnage de matériaux pleins, de profilés et de tubes.
- Durée de vie maximale.
- Haut rendement.
- Rigidité latérale élevée.

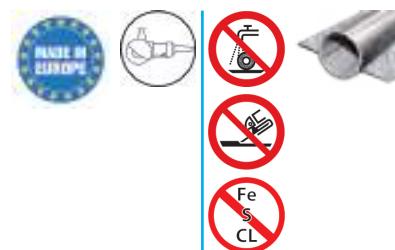

A



EN12413

ACIER, ACIER INOXYDABLE

Ø	Ø	Ø	Ø	Ø	Ø	REF	Ø	Ø	€
125	22,23	2,5	12250	80	F42	1702125	25	3661589002259	3,26
230	22,23	2,5	6650	80	F42	1702233	25	3661589002266	5,94



DAT.00129
TRONÇONNAGE 2 EN 1 INOX

- Tronçonner et réaliser des travaux d'ébarbage avec un seul disque.
- Gain de temps et de manipulation.
- Rapide et polyvalent.
- Travail confortable et finition soignée.
- Optimisé pour les machines sur batterie.



A



EN12413

ACIER, ACIER INOXYDABLE

Ø	Ø	Ø	Ø	Ø	Ø	REF	Ø	Ø	€
125	22,23	2,5	12250	80	F27	129.00.25	25	3661589036513	2,98

DISQUES À TRONÇONNER

MÉTAL



DAT.00120 ÉBARBAGE INOX

- Meule d'ébarbage haute performance.
- Durée de vie maximale.
- Taux d'enlèvement maximum.



A



EN12413

ACIER, ACIER INOXYDABLE

Ø	Ø	Ø	Ø	Ø	Ø	REF	Ø	Ø	€
125	22,23	7,0	12250	80	F27	1207125	10	3661589001894	3,90
230	22,23	7,0	6650	80	F27	1207230	10	3661589001917	8,67



DAT.00169 TRONÇONNAGE ALUMINIUM

- Idéal sur tous types de métaux non ferreux.
- Durée de vie maximale.
- Extra fin, coupe rapide et nette.
- Pas d'encrassement de la zone de coupe.



A



EN12413

ALUMINIUM

Ø	Ø	Ø	Ø	Ø	Ø	REF	Ø	Ø	€
125	22,23	1,2	12250	80	F41	1691121	25	3661589064356	2,73

MÉTAL



DAT.01601 TRONÇONNAGE FIN MÉTAL

- Idéal pour les tôles et profilés minces.
- Durée de vie maximale.
- Haut rendement.
- Coupe facile et rapide.



A



EN12413

ACIER

Ø	Ø	Ø	Ø	Ø	Ø	REF	Ø	Ø	€
115	22,23	1,0	13300	80	F41	1601110	25	3661589023056	2,31
115	22,23	1,6	13300	80	F41	1601111	25	3661589023063	2,21
125	22,23	1,0	12250	80	F41	1601120	25	3661589023070	2,41
125	22,23	1,6	12250	80	F41	1601121	25	3661589023087	2,25
230	22,23	2,0	6650	80	F41	1601232	25	3661589023094	5,78



DAT.00121 TRONÇONNAGE FIN MÉTAL

- Idéal pour les tôles et profilés minces.
- Longue durée de vie.
- Grande vitesse de coupe.
- Coupe facile et propre.

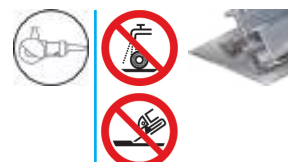

A

EN12413

ACIER

Ø	Ø	Ø	Ø	Ø	Ø	REF	Ø	Ø	€
115	22,23	1,0	13300	80	F41	110.00.25	25	3510780110006	2,02
125	22,23	1,0	12250	80	F41	120.00.25	25	3510780120005	2,12
125	22,23	1,6	12250	80	F41	121.00.25	25	3510780121002	1,83
230	22,23	1,8	6650	80	F41	231.00.25	25	3510780231008	4,10

DISQUES À TRONÇONNER

MÉTAL



DAT.01108 TRONÇONNAGE MINI MÉTAL

- Idéal pour les endroits difficiles d'accès.
- Longue durée de vie.
- Coupe précise et rapide.



ACIER

A



EN12413

Ø	Ø	Ø	Ø	Ø	Ø	REF	Ø	Ø	€
76	10	1,0	20100	80	F41	1108761	25	3661589001924	2,05
76	10	3,2	20100	80	F41	1108763	25	3661589001948	2,59



DAT.00160 TRONÇONNAGE MÉTAL

- Tronçonnage de matériaux pleins, de profilés et de tubes.
- Durée de vie maximale.
- Coupe facile et sans effort.
- Rigidité latérale élevée.
- 1603355 utilisable uniquement sur tronçonneuse de chantier jusqu'à 3KW.



ACIER

A



EN12413

Ø	Ø	Ø	Ø	Ø	Ø	REF	Ø	Ø	€
115	22,23	2,5	13300	80	F42	1602115	25	3661589001962	2,05
125	22,23	2,5	12250	80	F42	1602125	25	3661589001979	2,21
125	22,23	2,5	12250	80	F41	1605125	25	3661589002013	2,21
230	22,23	2,5	6650	80	F42	1602230	25	3661589001993	3,84
230	22,23	2,5	6650	80	F41	1605230	25	3661589002037	3,84
300	20	3,8	5100	80	F41	1604301	10	3661589002105	9,67
300	25,4	3,8	5100	80	F41	1604305	10	3661589002129	9,67
350	25,4	3,0	4400	80	F41	1603355	10	3661589002150	13,50
350	20	4,0	5500	100	F41	1604351	10	3661589031181	13,50
350	25,4	4,0	5500	100	F41	1604355	10	3661589002136	13,50

MÉTAL



DAT.XL00160 TRONÇONNAGE MÉTAL XLOCK

- Système X-LOCK pour un changement rapide et facile sans clé.
- Tronçonnage de matériaux pleins, de profilés et de tubes.
- Durée de vie maximale.
- Coupe facile et sans effort.
- Rigidité latérale élevée.



A



EN12413

ACIER

							REF			€
115	XLOCK	2,5	13300	80	F42	XL1602115	25	3661589101273	2,26	
125	XLOCK	2,5	12250	80	F42	XL1602125	25	3661589101280	2,44	



DAT.01104 TRONÇONNAGE RAILS

- Spécial rails de chemin de fer.
- Grande vitesse de coupe et longévité.
- Haut rendement.
- Rigidité latérale élevée.
- Utilisation uniquement sur tronçonneuse pour rails avec dispositif de blocage.

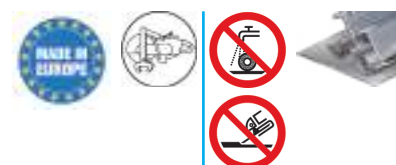

A



EN12413

ACIER

							REF			€
300	20	3,5	5100	80	F41	1104301	10	3661589001658	10,20	
350	25,4	4,0	5500	100	F41	1104355	10	3661589001689	13,40	

MÉTAL



DAT.00123 TRONÇONNAGE MÉTAL

- Tronçonnage de matériaux pleins, de profilés et de tubes.
- Longue durée de vie.
- Haute rigidité latérale.
- 353.28.25 utilisable uniquement sur tronçonneuse de chantier jusqu'à 3KW.

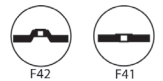
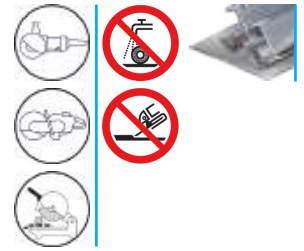

ACIER

A

EN12413

Ø	Ø	Ø	Ø	Ø	F41 F42	REF	Icon	Icon	€
115	22,23	3,0	13300	80	F42	113.00.25	25	3510780113007	1,50
125	22,23	3,0	12250	80	F42	123.00.25	25	3510780123006	1,68
180	22,23	3,0	8500	80	F42	173.00.25	25	3510780183000	2,85
230	22,23	3,0	6650	80	F42	233.00.25	25	3510780233002	3,00
300	20	3,8	5100	80	F41	304.05.25	10	3510780304054	7,50
300	22,23	3,8	5100	80	F41	305.05.25	10	3510780305051	7,50
300	25,4	3,8	5100	80	F41	303.05.25	10	3510780303057	7,50
350	25,4	3,0	4400	80	F41	353.28.25	10	3510780353281	10,50
350	25,4	4,0	5500	100	F41	353.05.25	10	3510780353052	10,50



DAT.01606 ÉBARBAGE MÉTAL

- Taux d'enlèvement maximum.
- Durée de vie maximale.
- Efficace, rapide et confortable.



ACIER

A

EN12413

Ø	Ø	Ø	Ø	Ø	F41 F42	REF	Icon	Icon	€
115	22,23	6,0	13300	80	F27	1606115	10	3661589002051	3,00
125	22,23	6,0	12250	80	F27	1606125	10	3661589002068	3,42
230	22,23	6,0	6650	80	F27	1606230	10	3661589002082	6,10

MÉTAL



DAT.00126 ÉBARBAGE MÉTAL

- Haute capacité d'enlèvement.
- Longue durée de vie.
- Rapide et confortable.



A

ACIER

EN12413

Ø	Ø	Ø	Ø	Ø	Ø	REF	Ø	Ø	€
115	22,23	6,0	13300	80	F27	116.00.25	10	3510780116008	2,53
125	22,23	6,0	12250	80	F27	126.00.25	10	3510780126007	2,85
180	22,23	6,0	8500	80	F27	176.00.25	10	3510780186001	4,73
230	22,23	6,0	6650	80	F27	236.00.25	10	3510780236003	5,10

MULTI-MATÉRIAUX



DAT.00124 TRONÇONNAGE MULTI-MATÉRIAUX

- Coupe tous types de matériaux.
- Longue durée de vie.
- Rapide et polyvalent.
- Gain de temps et de manipulation.

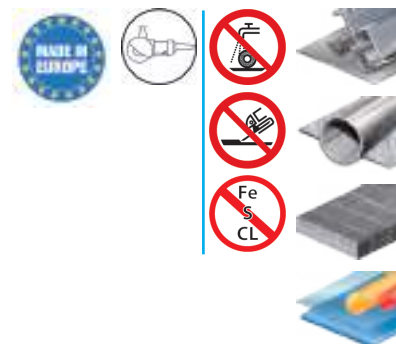

CARBURE
SILICIUM

ACIER, ACIER INOXYDABLE, ALUMINIUM, CARRELAGE, PIERRE, PARPAING, BRIQUE, PVC

EN12413

Ø	Ø	Ø	Ø	Ø	Ø	REF	Ø	Ø	€
125	22,23	1,6	12250	80	F41	124.16.25	25	3661589036520	2,15

DISQUES À TRONÇONNER

PIERRE



DAT.12310

TRONÇONNAGE MATÉRIAUX DE CONSTRUCTION, PIERRE

- Abrasif carbure de silicium.
- Longue durée de vie.
- Coupe sans effort.

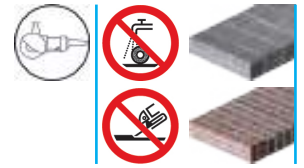

CARBURE SILICIUM

PIERRE, PARPAING, BRIQUE

EN12413

Ø	Ø	Ø	Ø	Ø	Ø	REF	Ø	Ø	€
115	22,23	3,0	13300	80	F42	113.10.25	25	3510780113106	1,90
125	22,23	3,0	12250	80	F42	123.10.25	25	3510780123105	2,05
230	22,23	3,0	6650	80	F42	233.10.25	25	3510780233101	3,26



PLÂTRE & MATÉRIAUX TENDRES



DAT.00017

TRONÇONNAGE CARBURE

- Rapide et polyvalent.
- Revêtement au carbure de tungstène.
- Utilisation facile et sûre.
- Extra fin, pour des coupes nettes et précises.



HM

BOIS, BOIS CLOUTÉ, PLÂTRE, PVC

Ø	Ø	Ø	Ø	Ø	Ø	REF	Ø	Ø	€
76	10	1,0	20100	80	F41	1707610	1	3661589092342	13,30
115	22,23	1,0	13300	80	F41	1711522	1	3661589092359	17,36
125	22,23	1,0	12250	80	F41	1712522	1	3661589092366	19,60



info@leman-sa.com

GUIDE DE CHOIX

P. 52

-  **MAÇONNERIE** P. 54
-  **CARRELAGE** P. 57
-  **MÉTAL** P. 61
-  **MULTI-MATÉRIAUX** P. 66
-  **PLÂTRE ET MATÉRIAUX TENDRES** P. 67

EXPERT  pour les travaux spécialisés et de haute technicité.

CLASSIC  pour les travaux courants et polyvalents.

GUIDE DE CHOIX

- Utilisation optimale
- Utilisation adaptée
- Utilisation possible

Gamme	Page	Machines	Qualité	Ø (mm)	Béton armé	Béton	Parpaing	Brique	Inox
TRE.00074	54	Perforateur SDS MAX	EXPERT	68 à 125	●	●●●	●●●	●●●	
TRE.00073	55	Perforateur SDS+	EXPERT	40 à 100		●●●	●●●	●●●	
TRE.00064	56	Perforateur SDS+	CLASSIC	40 à 100			●●●	●●●	
TRE.00066	58	Meuleuse / Visseuse / Perforateur SDS+	EXPERT	6 à 83					
TRE.00065	57	Visseuse	EXPERT	6 à 10					
TRE.00062	60	Visseuse	CLASSIC	6 à 127					
TRE.00037	61	Visseuse / Perforateur SDS+	EXPERT	22 à 83					●●●
TRE.00038	62	Visseuse / Perforateur SDS+	CLASSIC	16 à 200					
TRE.00080	66	Visseuse / Perforateur SDS+	CLASSIC	35 à 83				●●	
TRE.00500	67	Visseuse	CLASSIC	65 à 68					

TRÉPANS



MAÇONNERIE



MULTI-MATÉRIAUX



CARRELAGE



PLÂTRE ET MATÉRIAUX TENDRES



MÉTAL

	Alu, Métaux non ferreux	Acier	Plastique, PVC	Bois tendre	Bois dur	Plâtre	Granit, Pierre Naturelle	Marbre	Grès cérame	Carrelage, faïence
							...			
							...			
						
						
										...
				
				
						
						

MAÇONNERIE

EXPERT



HM

TRE.00074

**TRÉPAN CARBURE SDS MAX
CÔNE 1/8 BÉTON**

- Pour perforateur puissant de 900W à 1500W.
- Énergie d'impact jusqu'à 20 Joules.
- Robuste et performant.
- Haute résistance à l'usure.
- Goujure profonde qui réduit les frottements.



BÉTON, BRIQUE, PARPAING, PIERRE NATURELLE

Ø	L	Ø	REF		€
68	75	8	74.068	3661589083241	130,90
80	75	9	74.080	3661589083258	149,30
100	75	11	74.100	3661589083265	205,85
125	75	12	74.125	3661589083272	256,63

EXPERT



TRE.00742

PORTE TRÉPAN SDS MAX CÔNE 1/8



Ø	REF		€
220	74220	3661589083487	81,62
420	74420	3661589083494	98,76

EXPERT



TRE.00740

FORET CENTREUR POUR TRÉPAN CÔNE 1/8



Ø	Ø	REF		€
11	130	74000	3661589083470	10,72

EXPERT



TRE.00745

KIT D'EXTRACTION POUR TRÉPAN CÔNE 1/8



REF		€
74500	3661589083500	35,69

MAÇONNERIE

EXPERT 







TRE.00073
TRÉPAN CARBURE SDS+ M16 BÉTON



- Pour perceur intermédiaire de 700W à 950W.
- Robuste et performant.
- Haute résistance à l'usure.
- Goujure profonde qui réduit les frottements.

HM

BÉTON, BRIQUE, PARPAING, PIERRE NATURELLE



			REF		€
40	50	6	73.040	3661589083180	62,64
50	50	7	73.050	3661589083203	75,00
68	50	8	73.068	3661589083210	98,28
80	50	9	73.080	3661589083227	112,01
100	50	11	73.100	3661589083234	135,87

EXPERT 



TRE.00731
PORTE TRÉPAN SDS+ M16



	REF		€
100	73100	3661589083296	35,15
220	73220	3661589083302	51,08

EXPERT 



TRE.00730
FORET CENTREUR POUR TRÉPAN M16



		REF		€
8	100	73000	3661589083289	9,64

CLASSIC



HM

TRE.00064

KIT TRÉPAN CARBURE SDS+ BÉTON



- Pour perceuseur d'une puissance inférieure à 700W.
- Kit prêt à l'emploi, avec mandrin et foret de centrage.

BÉTON, BRIQUE, PARPAING

Ø	U	Ø	REF		€
40	60	5	64.040	3661589063342	33,22
45	60	5	64.045	3661589063311	34,85
50	60	6	64.050	3661589063328	37,02
65	60	8	64.065	3661589063335	42,31
68	60	8	64.068	3661589063359	42,64
80	60	8	64.080	3661589063366	49,35
100	60	12	64.100	3661589063373	58,01

CLASSIC



TRE.00640

FORET CENTREUR POUR TRÉPAN TYPE 64



Ø	Ø	REF		€
8	110	64000	3661589063403	7,58

CARRELAGE

EXPERT



DIAMANT

TRE.00065

TRÉPAN DIAMANTÉ 6 PANS GRÈS CÉRAME

- Technologie vacuum brazed.
- Grande résistance aux températures élevées pendant le perçage.
- Excellente performance et longévité.
- Trous précis et nets.



CARRELAGE, FAÏENCE, MARBRE, GRANIT, CÉRAMIQUE, GRÈS CÉRAME, PIERRE NATURELLE

			REF		€
6	32	10,0	65.006	3661589029515	23,56
8	32	10,0	65.008	3661589029522	23,84
10	32	10,0	65.010	3661589029539	24,62

CLASSIC



DIAMANT

TRE.06500

LOT DE 5 TRÉPANS DIAMANTÉS 6 PANS GRÈS CÉRAME

- Technologie vacuum brazed.
- Grande résistance aux températures élevées pendant le perçage.
- Excellente performance et longévité.
- Trous précis et nets.



CARRELAGE, FAÏENCE, MARBRE, GRANIT, CÉRAMIQUE, GRÈS CÉRAME, PIERRE NATURELLE

			REF		€
5/6/8/10/12	35	10,0	6500.05	3661589083050	77,92

CARRELAGE

EXPERT



TRE.00066 TRÉPAN DIAMANTÉ M14 GRÈS CÉRAME

- Rapide et confortable sur meuleuse.
- Technologie vacuum brazed.
- Grande résistance aux températures élevées pendant le perçage.
- Excellente performance et longévité.
- Trous précis et nets.



CARRELAGE, FAÏENCE, MARBRE, GRANIT, CÉRAMIQUE, GRÈS CÉRAME, PIERRE NATURELLE

DIAMANT

Ø	U	Ø	REF	Ø	€
6	35	10,0	66.006	3661589092229	24,80
8	35	10,0	66.008	3661589092236	25,10
10	35	10,0	66.010	3661589092243	25,92
12	35	10,0	66.012	3661589092250	27,96
20	35	10,0	66.020	3661589092267	37,84
27	35	10,0	66.027	3661589092274	49,60
35	35	10,0	66.035	3661589092281	61,94
44	35	10,0	66.044	3661589095398	79,20
55	35	10,0	66.055	3661589092298	89,00
68	35	10,0	66.068	3661589092304	99,30
72	35	10,0	66.072	3661589092311	105,20
83	35	10,0	66.083	3661589092328	120,30

EXPERT



TRE.00063 ADAPTATEUR POUR TRÉPAN DIAMANTÉ M14 TYPE 66



REF	Ø	€
RACCORD M14 / 6 PANS 63.002	3661589039668	30,00
RACCORD M14 / SDS+ 63.003	3661589039675	30,00

CARRELAGE

EXPERT



TRE.06605 COFFRET DE 5 TRÉPANS DIAMANTÉS M14 GRÈS CÉRAME

- Rapide et confortable sur meuleuse.
- Technologie vacuum brazed.
- Grande résistance aux températures élevées pendant le perçage.
- Excellente performance et longévité.
- Trous précis et nets.



CARRELAGE, FAÏENCE, MARBRE, GRANIT, CÉRAMIQUE, GRÈS CÉRAME, PIERRE NATURELLE

DIAMANT

Ø	U	Icon	REF	Icon	€
20/27/35/55/68	35	10,0	VAL66.05	3661589092335	309,00

CLASSIC



TRE.62001 GUIDE DE PERÇAGE INOX POUR TRÉPAN DIAMANTÉ

- Pour trépan diamanté de 4 à 76 mm.
- Fixation par ventouse.
- Pratique et facile d'utilisation.

Ø	REF	Icon	€
4 - 76	62.001	3510780113212	26,68

CARRELAGE

CLASSIC



DIAMANT

TRE.00062 TRÉPAN DIAMANTÉ 6 PANS CARRELAGE

- Trépan diamanté par électrolyse.
- Coupe nette et précise.
- Utilisation uniquement à eau.
- Chaque trépan est livré avec une éponge à imbiber d'eau (à partir du Ø 19 mm).

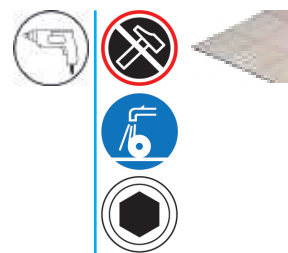

CARRELAGE, FAÏENCE

Ø	U	Ø	REF	REF	€
6	35	4,0	62.006	3661589001474	11,80
8	35	4,0	62.008	3661589001481	13,64
10	35	4,0	62.010	3661589001498	15,75
12	35	4,0	62.012	3661589001504	19,43
19	35	4,0	62.019	3510780113038	20,94
22	35	4,0	62.022	3510780113069	25,00
29	35	4,0	62.029	3661589001511	29,50
35	35	4,0	62.035	3510780113083	36,53
41	35	4,0	62.041	3510780113090	42,76
44	35	4,0	62.044	3510780113120	46,00
51	35	4,0	62.051	3510780113137	52,87
65	35	4,0	62.065	3510780113175	61,69
67	35	4,0	62.067	3510780113182	64,50
68	35	4,0	62.068	3661589075574	64,50
83	35	4,0	62.083	3661589088024	79,74
102	35	4,0	62.102	3661589081711	107,96
112	35	4,0	62.112	3661589081728	118,18
127	35	4,0	62.127	3661589081735	133,58

CLASSIC



DIAMANT

TRE.04071 COFFRET DE 10 TRÉPANS DIAMANTÉS 6 PANS CARRELAGE

- 10 trépan diamantés + 1 guide de perçage en inox.
- Trépan diamanté par électrolyse.
- Coupe nette et précise.
- Utilisation uniquement à eau.
- Chaque trépan est livré avec une éponge à imbiber d'eau (à partir du Ø 22 mm).

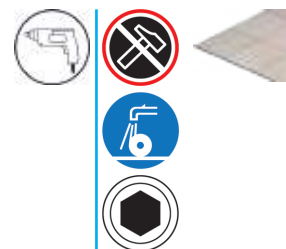

CARRELAGE, FAÏENCE

Ø	U	Ø	REF	REF	€
6/8/10/22/35/41/44/51/65/68	35	4,0	4071	3661589024787	226,16

MÉTAL

EXPERT



TRE.00037 TRÉPAN BI-MÉTAL COBALT 8%

- Denture HSS à 8% de cobalt.
- Grande résistance et longévité.
- Denture à pas variable pour une coupe plus rapide.
- Réduction des vibrations et une meilleure finition.
- Fond usiné en tôle épaisse.



BI-MÉTAL

HSS
CO8

ACIER INOXYDABLE, ACIER, ALUMINIUM, PVC, BOIS, PLÂTRE

Ø	U	REF		€
22	38	37.022	3661589095299	13,88
25	38	37.025	3661589095305	15,28
29	38	37.029	3661589095312	16,56
35	38	37.035	3661589095329	18,12
44	38	37.044	3661589095336	20,26
51	38	37.051	3661589095343	21,75
60	38	37.060	3661589095350	25,98
68	38	37.068	3661589095367	28,74
76	38	37.076	3661589095374	31,20
83	38	37.083	3661589095381	33,80

EXPERT



TRE.05806 COFFRET DE 6 TRÉPANS BI-MÉTAL COBALT 8%

- Grande résistance et longévité.
- 6 trépan bi-métal. Denture HSS à 8% de cobalt.
- 2 mandrins, 2 forets de centrage, 1 adaptateur.



BI-MÉTAL

HSS
CO8

ACIER INOXYDABLE, ACIER, ALUMINIUM, PVC, BOIS, PLÂTRE

Ø	U	REF		€
22/29/35/44/51/68	38	5806	3661589095411	96,00

CLASSIC



BI-MÉTAL HSS

TRE.00038
TRÉPAN BI-MÉTAL

- Grande polyvalence et précision.
- Denture à pas variable pour une coupe plus rapide.
- Réduction des vibrations et une meilleure finition.
- Fond usiné en tôle épaisse.

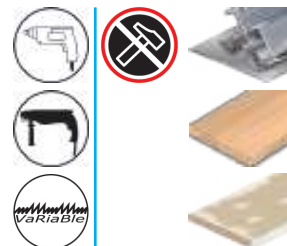

ACIER, ALUMINIUM, PVC, BOIS, PLÂTRE

Ø	U	REF		€
16	38	38.016	3510780380164	10,50
20	38	38.020	3510780380201	10,90
22	38	38.022	3510780380225	11,10
25	38	38.025	3510780380256	12,22
27	38	38.027	3510780380270	12,90
29	38	38.029	3510780380294	13,25
30	38	38.030	3510780380300	13,38
32	38	38.032	3510780380324	14,35
35	38	38.035	3510780380355	14,50
38	38	38.038	3510780380386	14,75
40	38	38.040	3510780380409	14,96
43	38	38.043	3510780380430	15,43
44	38	38.044	3510780380447	16,20
48	38	38.048	3510780380485	17,00
51	38	38.051	3510780380515	17,75
54	38	38.054	3510780380546	19,96
57	38	38.057	3510780380577	20,54
60	38	38.060	3510780380607	20,78
65	38	38.065	3510780380652	22,70
67	38	38.067	3510780380676	22,80
68	38	38.068	3510780380683	22,98
70	38	38.070	3510780380706	23,10
73	38	38.073	3510780380737	23,76
76	38	38.076	3510780380768	24,90
80	38	38.080	3510780380805	25,60
83	38	38.083	3510780380836	26,41
92	38	38.092	3510780380928	31,57
102	38	38.102	3510780381024	32,30
108	38	38.108	3510780381086	40,04
127	38	38.127	3510780103404	50,36
152	38	38.152	3661589067388	66,90
200	38	38.200	3661589067395	82,50

MÉTAL



TRE.03004 LOT DE 4 TRÉPANS BI-MÉTAL

- Grande polyvalence et précision.
- 4 trépan bi-métal.
- 1 mandrin, 1 foret de centrage, 1 adaptateur.

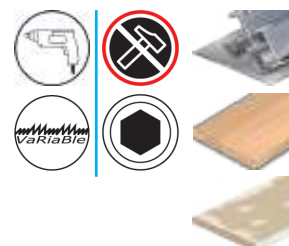

BI-MÉTAL HSS

ACIER, ALUMINIUM, PVC, BOIS, PLÂTRE

Ø	U	REF		€
22/35/44/68	38	3004	3661589060587	42,21



TRE.05006 COFFRET DE 6 TRÉPANS BI-MÉTAL

- Grande polyvalence et précision.
- 6 trépan bi-métal.
- 2 mandrins, 2 forets de centrage, 1 adaptateur.

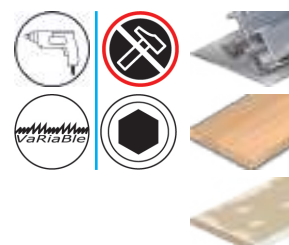

BI-MÉTAL HSS

ACIER, ALUMINIUM, PVC, BOIS, PLÂTRE

Ø	U	REF		€
22/29/35/44/51/68	38	5006	3661589095428	76,34



BI-MÉTAL HSS

TRE.05013
COFFRET DE 13 TRÉPANS BI-MÉTAL «INDUSTRIE»

- Grande polyvalence et précision.
- 13 trépan bi-métal.
- 2 mandrins, 3 forets de centrage.

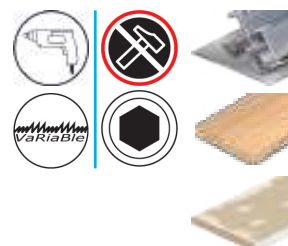

ACIER, ALUMINIUM, PVC, BOIS, PLÂTRE

		REF		€
16/22/25/29/35/38/43/51/65/ 67/68/76/102	38	5013	3661589025920	150,42



TRE.00060
EMPORTE-PIÈCES POUR INOX

- Découpe facile et précise à la main.
- Pour les tôles en acier et inox.
- Idéal pour les éviers en inox.

	REF		€
32	6030	3510780104609	30,79
35	6031	3661589038883	32,38



HSS

TRE.10080
MANDRIN 6 PANS POUR TRÉPAN Ø14 A 30 MM

- Entraînement par hexagone de 9,5 mm.
- Mandrin équipé d'un foret HSS Ø6,35 x 80 mm.



REF		€
10080	3510780100809	12,29



HSS

TRE.10030
MANDRIN SDS+ POUR TRÉPAN Ø14 A 30 MM

- Entraînement SDS+.
- Mandrin équipé d'un foret HSS Ø6,35 x 80 mm.
- Ne jamais utiliser la percussion.



REF		€
10030	3510780100304	15,48

MÉTAL

CLASSIC



HSS

TRE.10060 MANDRIN 6 PANS POUR TRÉPAN Ø32 A 210 MM

- Entraînement par hexagone de 9,5 mm.
- Mandrin équipé d'un foret HSS Ø6,35 x 100 mm.



REF		€
10060	3510780100601	26,52

CLASSIC



HSS

TRE.10070 MANDRIN 6 PANS POUR TRÉPAN Ø32 A 210 MM

- Entraînement par hexagone de 11,11 mm.
- Mandrin équipé d'un foret HSS Ø6,35 x 100 mm.



REF		€
10070	3510780100700	26,52

CLASSIC



HSS

TRE.10020 MANDRIN SDS+ POUR TRÉPAN Ø32 A 210 MM

- Entraînement SDS+ .
- Mandrin équipé d'un foret HSS Ø6,35 x 100 mm.
- Ne jamais utiliser la percussion.



REF		€
10020	3510780100205	28,09

CLASSIC



HSS

TRE.10090 MANDRIN AUTOMATIQUE POUR TRÉPAN Ø14 A 210 MM

- Remplacez et montez chaque trépan en un seul clic.
- Simple et rapide.
- Entraînement par hexagone de 8,5 mm.
- Livré avec 5 adaptateurs



REF		€
10090.05	3661589080721	48,71

CLASSIC



HSS

TRE.01000 FORET DE CENTRAGE HSS

- Foret de centrage HSS.
- Ø6.35 X 100 mm ou 80 mm.



	REF		€
80	800	3510780008006	2,71
100	1000	3510780010009	4,06

MULTI-MATÉRIAUX

CLASSIC



TRE.00080 TRÉPAN CARBURE MULTI-MATÉRIAUX

- Efficace dans de nombreux matériaux.
- Longévité et performances exceptionnelles.
- Un travail propre et rapide.
- Évacuation optimale des copeaux grâce à la conception des larges encoches.



HM

BOIS, PLÂTRE, BRIQUE, PVC

Ø	L	Flutes	REF	Code	€
35	60	1	80.035	3661589085344	12,99
44	60	2	80.044	3661589085351	14,62
51	60	3	80.051	3661589085368	17,54
60	60	3	80.060	3661589085375	19,00
68	60	3	80.068	3661589085382	22,25
76	60	4	80.076	3661589085399	24,36
83	60	4	80.083	3661589085405	26,52

CLASSIC



TRE.08000 COFFRET DE 5 TRÉPANS CARBURE MULTI-MATÉRIAUX

- 5 trépan, 1 mandrin, 1 foret pilote.
- Efficace dans de nombreux matériaux.
- Longévité et performances exceptionnelles.
- Un travail propre et rapide.
- Évacuation optimale des copeaux grâce à la conception des larges encoches.



HM

BOIS, PLÂTRE, BRIQUE, PVC

Ø	L	REF	Code	€
35/44/51/60/68	60	8000.05	3661589085498	127,69

MULTI-MATÉRIAUX



TRE.23864
LOT DE 2 TRÉPANS SDS+ Ø68
SPECIAL BOITIER ELECTRIQUE

- 1 trépan bi-métal, 1 mandrin, 1 foret de centrage.
- 1 trépan carbure.

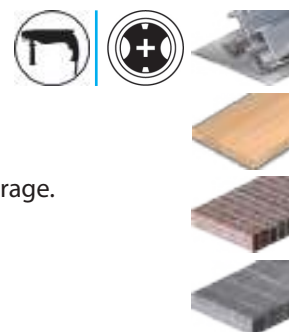

HM BI-MÉTAL

BÉTON, BRIQUE, PARPAING, ACIER, ALUMINIUM, PVC, BOIS, PLÂTRE

Ø	REF		€
68	2.3864068	3661589072818	59,42

PLÂTRE & MATÉRIAUX TENDRES



TRE.00500
SCIE CLOCHE BOIS, PLÂTRE

- Spécial boîtier électrique.
- Kit prêt à l'emploi, avec mandrin et foret de centrage.
- Lame en acier, support en aluminium moulé.



ACIER

BOIS, PLÂTRE

Ø		REF		€
65	40	50065	3510780500654	9,41
68	40	50067	3510780500678	9,74



info@leman-sa.com

GUIDE DE CHOIX P. 70

INFOS TECHNIQUES P. 72

 **BOIS MASSIF** P. 74

 **PANNEAUX & DÉRIVÉS DU BOIS** P. 85

 **MULTI-MATÉRIAUX** P. 94

 **MÉTAL** P. 99

 **ACCESSOIRES** P. 108

EXPERT  pour les travaux spécialisés et de haute technicité.

CLASSIC  pour les travaux courants et polyvalents.



GUIDE DE CHOIX

- Utilisation optimale
- Utilisation adaptée
- Utilisation possible

Série	Page	Machines	Qualité	Bois massif	Bois de chauffage	Bois de coffrage	Bois avec clous	Panneau MDF/HDF	Panneau contre-plaqué	Panneau latté
LSC.966KV	74	S	CLASSIC	●●●	●●●					
LSC.966NV/NVL	75	S	CLASSIC	●●●	●●●					
LSC.00222	76	S	CLASSIC	●●●	●●●					
LSC.00215	77	S	CLASSIC	●●●						
LSC.ET002	77	S	EXPERT	●●●				●	●	●
LSC.00328	78	S	CLASSIC	●●●				●	●	●
LSC.00360	79	S	CLASSIC	●●●				●●	●●	●●
LSC.00909	80	P	CLASSIC	●●●				●●	●●	●●
LSC.E64BAN	80	P	EXPERT	●●●				●●	●●	●●
LSC.964BAN/BA	81	P & S	CLASSIC	●●●				●●	●●	●●
LSC.964TK	81	P	CLASSIC	●●●				●●	●●	●●
LSC.E64TF	85	P	CLASSIC					●●●	●●	●●
LSC.964TF	85	P	CLASSIC					●●●	●●	●●
LSC.E0003	86	S	EXPERT	●●				●●	●●●	●●●
LSC.00338	87	S	CLASSIC	●●				●●	●●●	●●●
LSC.E04TF	88	S	EXPERT					●●	●●	●●
LSC.ET4TF	88	S	EXPERT					●●	●●	●●
LSC.338TF	89	S	CLASSIC					●●	●●	●●
LSC.00356	90	S	CLASSIC							
LSC.00357	90	S	CLASSIC							
LSC.E0005/N	91	S	EXPERT							
LSC.00354/N	92	S	CLASSIC							
LSC.E0009BA/TP	99	P & S	EXPERT							
LSC.E0011	100	P & S	EXPERT							
LSC.00120	101	P & S	CLASSIC							
LSC.ET007	100	S	EXPERT							
LSC.112AL	102	S	CLASSIC							
LSC.118AL	103	S	CLASSIC							
LSC.964AL	104	P	CLASSIC							
LSC.00355	94	P & S	CLASSIC							
LSC.00923	94	P & S	CLASSIC	●			●	●	●	●
LSC.223BA/TF	95	P	CLASSIC	●●●		●●●	●●		●	●
LSC.00224	96	P & S	CLASSIC			●●●	●●			
LSC.DI350PL/BA	97	P & S	CLASSIC					●		
LSC.E0123S/M/L	98	P & S	EXPERT	●			●	●	●	●

MATIÈRE OUTIL

CV

ACIER CHROME-VANADIUM

- Économique : coupes simples, non précises.
- Pour les bois massifs et le bois de chauffage.
- Affûtable manuellement

HM

CARBURE DE TUNGSTÈNE

- Plus répandu car plus résistant que l'acier.
- Beaucoup d'applications, selon la nuance de carbure & des angles d'affûtage.
- Se présente sous forme de plaquettes rapportées, brasées sur le corps de lame.

PCD

DIAMANT

- Sous forme de plaquettes rapportées.
- Destinée aux matériaux abrasifs, silicieux du Bâtiment.

CÉRAMÉTAL

CÉRAMIQUE-MÉTAL

- Nouvelle technologie, plus résistante aux matériaux durs et plus de longévité.

ALÉSAGE

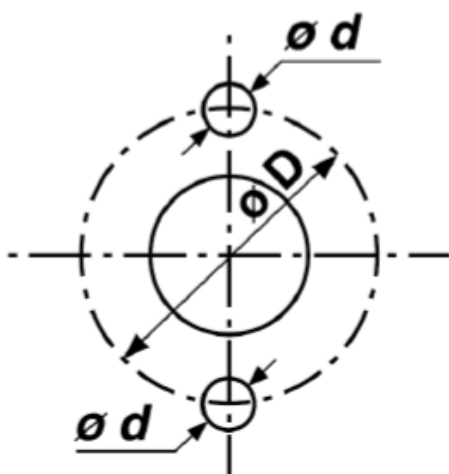

TROUS D'ERGOTS

- d** : Diamètre du trou d'ergot
D : Diamètre de l'entraxe

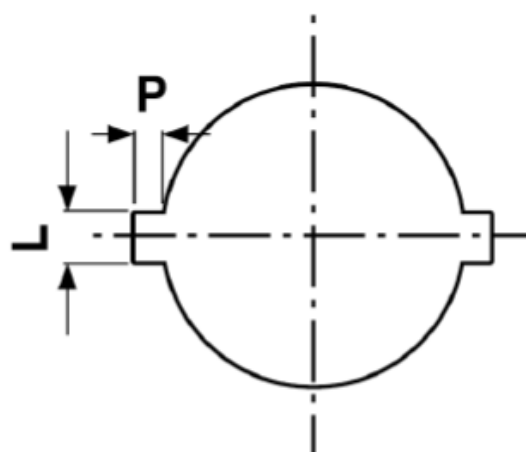

RAINURES DE CLAVETTE

- L** : Largeur de la rainure de clavette
P : Profondeur de la rainure de clavette

DENTURES

FZ



DENTURE PLATE

Pour le bois, en délignage, dans le sens du fil.
Pour du rainurage ou l'incision de mélaminés.

DMZ

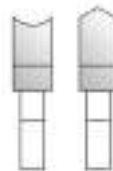

DENTURE GOUGE

Une dent en forme de pointe à laquelle succède une dent creuse.
Denture par excellence pour les panneaux mélaminés.

TFZ

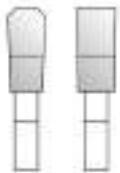

DENTURE TRAPÉZOÏDALE PLATE

Une dent en forme de trapèze à laquelle succède une dent plate.
Les dents trapézoïdales font l'ébauche de la coupe et les dents plates la finissent.
Pour les panneaux dérivés, ainsi que les aluminium et PVC.

FLAT 2

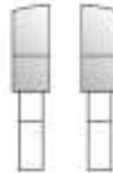

DENTURE PLATE AVEC CHANFREIN ALTERNÉE

Pour couper les métaux à sec, sur des machines appropriées, dites «dry-cutter», à vitesse de rotation basse.

WZ

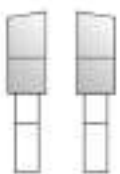

DENTURE BIAISE ALTERNÉE

Se présente avec un biseau alterné à droite & à gauche. Très répandue.
Pour le bois et les panneaux dérivés, également en multi-usages.
Pour certaines applications ciblées, par exemple le plexiglas.

TZ



DENTURE TRAPÉZOÏDALE

Toutes les dents ont la forme de trapèze.
Sur certaines lames de chantier, avec un carbure plus souple pour absorber les chocs.
Pour la découpe de palettes, de planches de coffrages avec clous ou gravillons.

KON



DENTURE CONIQUE

Utilisée sur les inciseurs pour mélaminés.
Sa forme géométrique réalise une incision plus ou moins épaisse en fonction de la lame principale utilisée.

V



DENTURE EN POINTE

Pour le rainurage en «V» et non la coupe.
Pour la réalisation visuelle d'un grain d'orge sur panneaux lattés imitant les volets traditionnels.



BOIS MASSIF

CLASSIC



LSC.966KV

LAME ACIER POUR LA DÉCOUPE DE BOIS DE CHAUFFAGE ET BOIS VERT

- Lame en acier pour la découpe de bois en section et de bois de chauffage.
- Denture crochet avoyée, affûtée.

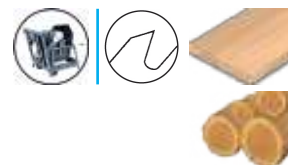

BOIS, BOIS DE CHAUFFAGE

CV

EN847-1

Trous d'ergots jusqu'au ø450 2/10/60

Trous d'ergots à partir du ø500 2/12/72

Ø	mm	mm	mm	mm	REF	REF	€
250	30	3,3/2,0	48	966.250.2048	3510789660229	26,57	
300	30	3,3/2,0	48	966.300.2048	3510789660236	30,41	
315	30	3,0/1,8	56	966.315.1856	3510789660243	30,41	
350	30	3,6/2,2	56	966.350.2256	3510789660250	36,69	
350	30	4,1/2,5	48	966.350.2548	3510789660267	44,32	
400	30	3,3/2,0	56	966.400.2056	3510789660274	49,35	
400	30	4,1/2,5	48	966.400.2548	3510789660281	56,93	
450	30	4,1/2,5	56	966.450.2556	3510789660311	84,19	
500	30	4,1/2,5	56	966.500.2556	3510789660816	85,65	
500	30	5,0/3,0	56	966.500.3056	3510789660335	103,46	
550	30	4,1/2,5	56	966.550.2556	3510789660342	106,70	
600	30	4,6/2,8	56	966.600.2856	3510789660823	107,57	
600	30	4,6/2,8	72	966.600.2872	3510789660359	110,38	
650	30	5,0/3,0	56	966.650.3056	3510789660373	166,38	
700	30	5,3/3,2	56	966.700.3256	3510789660380	195,33	

BOIS MASSIF

CLASSIC



LSC.966NV

LAME ACIER POUR LA DÉCOUPE DE BOIS DE CHAUFFAGE ET BOIS VERT

- Lame en acier pour la découpe de bois en section et de bois de chauffage.
- Denture couchée avoyée, affûtée.

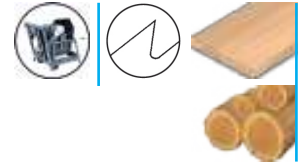

CV

EN847-1

BOIS, BOIS DE CHAUFFAGE

Trous d'ergots jusqu'au \varnothing 450 2/10/60
Trous d'ergots à partir du \varnothing 500 2/12/72

				REF		€
250	30	2,6/1,6	80	966.250.1680	3510789660427	43,56
300	30	3,3/2,0	100	966.300.2010	3510789660441	48,81
350	30	4,1/2,5	100	966.350.2510	3510789660489	67,65
400	30	4,1/2,5	80	966.400.2580	3510789660519	79,65
450	30	4,1/2,5	96	966.450.2596	3510789660540	84,88
500	30	4,1/2,5	80	966.500.2580	3510789660557	106,70
500	30	5,0/3,0	96	966.500.3096	3510789660571	113,30
550	30	4,1/2,5	96	966.550.2596	3510789660618	117,26
600	30	4,6/2,8	80	966.600.2880	3510789660632	149,82
600	30	4,6/2,8	96	966.600.2896	3510789660885	149,82

CLASSIC



LSC.966NVL

LAME ACIER POUR LA DÉCOUPE AU LAMIER

- Pour l'élagage.
- Denture couchée avoyée, affûtée.



CV

EN847-1

BOIS

Trous d'ergots 2/18/120

				REF		€
600	45	6,6/4,0	96	966.600.40.4596	3661589064646	205,61
700	45	6,6/4,0	96	966.700.40.4596	3661589064653	238,07
700	50	6,6/4,0	96	966.700.40.5096	3661589072870	238,07

BOIS MASSIF



LSC.00222

LAME DE DÉBIT DE BOIS MASSIF

- Lame de débit avec anti-recul.
- Spécialement conçue pour la coupe en long et en travers de tous les bois naturels, bois de chauffage.

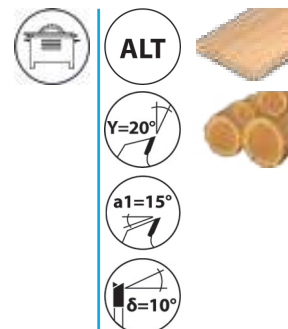

HM

EN847-1

BOIS, BOIS DE CHAUFFAGE

Trous d'ergots combinés 2/7/42 + 2/9/46,4 + 2/10/60
Trous d'ergots supplémentaires 2/12/72 à partir du ø 500

Ø	mm	mm	mm	mm	REF	IBS	€
200	30	3,2/2,2	18	222.200.3018	3510782221069	49,62	
250	30	3,2/2,2	18	220.250.3018	35107822201016	56,60	
250	30	3,2/2,2	24	222.250.3024	3510782221007	52,32	
300	30	3,2/2,2	24	220.300.3024	35107822201023	64,93	
300	30	3,2/2,2	28	222.300.3028	3510782221014	65,85	
315	30	3,2/2,2	24	222.315.3024	3510782221076	79,38	
350	30	3,5/2,5	24	220.350.3024	35107822201030	69,00	
350	30	3,5/2,5	32	222.350.3032	3510782221021	74,28	
380	30	3,5/2,5	28	222.380.3028	3510782221083	98,53	
400	30	3,5/2,5	28	220.400.3028	35107822201047	98,53	
400	30	3,5/2,5	36	222.400.3036	3510782221038	86,94	
420	30	3,5/2,5	30	222.420.3030	3510782221090	140,58	
450	30	4,0/2,8	32	220.450.3032	35107822201054	115,58	
500	30	4,0/2,8	36	220.500.3036	35107822201061	124,04	
550	30	4,0/2,8	36	220.550.3036	3661589078995	176,50	
600	30	4,0/2,8	40	220.600.3040	35107822201078	185,62	
650	30	4,2/3,2	44	220.650.3044	3661589079008	252,14	
700	30	4,4/3,2	46	220.700.3046	35107822201085	259,49	

LAMES DE SCIE CIRCULAIRE

BOIS MASSIF



LSC.00215

LAME DE DÉBIT DE BOIS MASSIF

- Lame de délignage anti-recul avec racleurs pour le débit de bois épais, vert et humide.

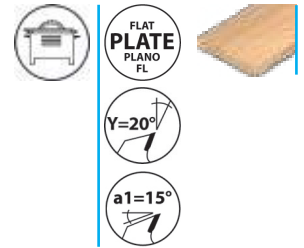

HM

EN847-1

BOIS

Trous d'ergots combinés 2/7/42 + 2/9/46,4 + 2/10/60

				REF		€
250	30	3,2/2,2	18+3	215.250.3018	3510782150017	80,63
300	30	3,2/2,2	18+3	215.300.3018	3510782150024	88,79
350	30	3,6/2,5	20+4	215.350.3020	3510782150031	109,30
400	30	4,0/2,8	24+4	215.400.3024	3510782150048	129,75



LSC.ET002

LAME DE MISE À FORMAT DE BOIS MASSIF ET PANNEAUX DÉRIVÉS DU BOIS

- Lame conçue pour la coupe en long de tous les bois naturels et panneaux de particules bruts.
- Tôle silencieuse avec découpes laser.
- Revêtement Téflon: réduction des frictions et protection préventive optimale contre la corrosion.

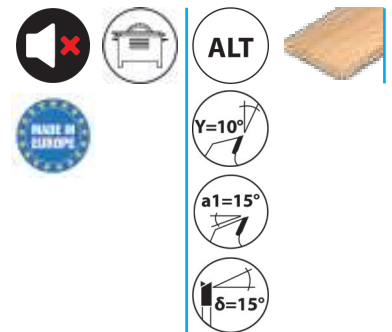

HM

TEFLON

EN847-1

BOIS

Trous d'ergots combinés 2/7/42 + 2/9/46,4 + 2/10/60

				REF		€
300	30	3,2/2,2	48	364AT30048	3510783640005	95,18

BOIS MASSIF



LSC.00328

LAME DE MISE À FORMAT DE BOIS MASSIF ET PANNEAUX DÉRIVÉS DU BOIS

- Utilisation universelle coupe en long et en travers pour les bois tendres, durs et exotiques ainsi que pour les panneaux plaqués une face ou stratifiés.

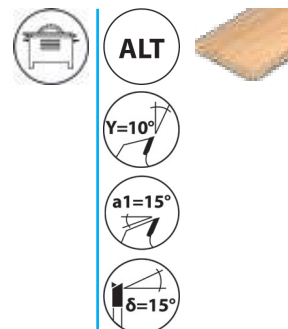

HM

EN847-1

BOIS

Trous d'ergots combinés 2/7/42 + 2/9/46,4 + 2/10/60

				REF		€
200	30	3,2/2,2	40	328.200.3040	3510783261170	66,24
250	30	3,2/2,2	30	326.250.3030	3510783261002	62,56
250	30	3,2/2,2	40	328.250.3040	3510783261019	64,80
250	30	3,2/2,2	48	334.250.3048	3510783261026	82,95
300	30	3,2/2,2	36	326.300.3036	3510783261040	71,14
300	30	3,2/2,2	48	328.300.3048	3510783261057	74,28
300	30	3,2/2,2	60	334.300.3060	3510783261064	82,74
315	30	3,2/2,2	48	328.315.3048	3510783261071	84,88
350	30	3,5/2,5	42	326.350.3042	3510783261088	96,21
350	30	3,5/2,5	54	328.350.3054	3510783261095	90,18
350	30	3,5/2,5	72	334.350.3072	3510783261101	117,80
400	30	3,5/2,5	48	326.400.3048	3510783261118	98,60
400	30	3,5/2,5	60	328.400.3060	3510783261125	102,84
400	30	3,5/2,5	84	334.400.3084	3510783261132	143,22
500	30	4,0/2,8	60	326.500.3060	3510783261156	204,37

BOIS MASSIF



LSC.00360

LAME POUR RAINURAGE DE BOIS ET
PANNEAUX DÉRIVÉS DU BOIS

- Montage sur toupie ou machine CNC.

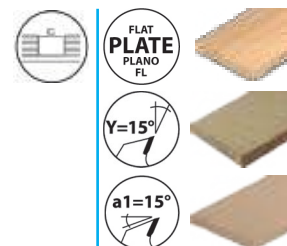

HM

EN847-1

BOIS, AGGLOMÉRÉ, MDF/HDF

				REF		€
100	20	4,0/2,8	12	360.100.4012	3510783601105	57,68
125	30	1,5/1,0	12	360.125.1512	3510783601167	57,68
125	30	2,0/1,4	12	360.125.2012	3510783601457	57,68
125	30	2,2/1,6	12	360.125.2212	3510783601181	57,68
125	30	2,5/2,0	12	360.125.2512	3510783601198	60,12
125	30	3,0/2,2	12	360.125.3012	3510783601204	74,67
125	30	3,5/2,5	12	360.125.3512	3510783601211	87,28
125	30	4,0/2,8	12	360.125.4012	3510783601228	100,15
125	30	5,0/2,8	12	360.125.5012	3510783601242	108,27
150	30	3,0/2,0	12	360.150.3012	3510783601259	90,58
150	30	4,0/2,8	12	360.150.4012	3510783601273	103,73
150	30	5,0/3,0	12	360.150.5012	3510783601303	123,47
150	30	6,0/4,0	12	360.150.6012	3510783601327	136,13
150	30	8,0/6,0	12	360.150.8012	3510783601358	177,90
180	30	4,0/3,0	12	360.180.4012	3510783601402	132,24
180	30	5,0/3,2	12	360.180.5012	3510783601419	146,57
180	30	6,0/4,0	12	360.180.6012	3510783601426	153,83
180	30	8,0/6,0	12	360.180.8012	3510783601433	195,76
125	50	3,0/2,2	12	361.125.3012	3510785402465	88,46
150	50	3,0/2,0	12	361.150.3012	3510785402502	90,58
150	50	4,0/2,8	12	361.150.4012	3510785402519	103,73

BOIS MASSIF



LSC.00909

LAME POUR RAINURAGE GRAIN D'ORGE EN V

- Denture V, rainurage grain d'orge.

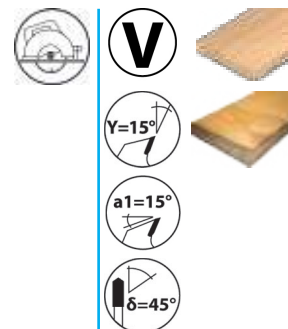

HM

EN847-1

BOIS, BOIS LATTÉ

Trous d'ergots 2/6/32

				REF		€
160	20	6,0/3,5	12	909.160.2012	3661589056856	108,21



LSC.E64BAN

LAME DE SCIE CIRCULAIRE POUR MACHINES PORTATIVES

- Lame haute performance pour la coupe du bois et panneaux dérivés.
- Denture alternée en attaque négative pour scie plongeante.

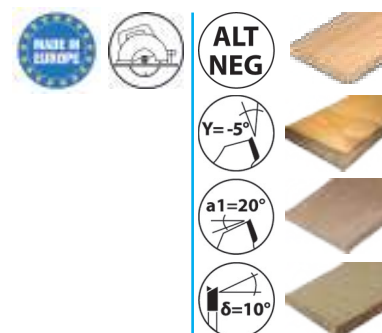

HM
MICROGRAIN

EN847-1

BOIS, BOIS LATTÉ, CONTREPLAQUÉ, AGGLOMÉRÉ

Epaisseur 2,2 sans rivet cuivre.

				REF		€
160	20	2,2/1,6	48	GOLD64.1602248	3661589079015	58,83
160	20	2,5/1,8	48	GOLD64.1602548	3510785433681	76,13

LAMES DE SCIE CIRCULAIRE

BOIS MASSIF



LSC.964BAN

LAME TOUTES SCIES POUR LE BOIS MASSIF

- Denture alternée pour bois.
- Lames jusqu'à 235 mm livrées avec bagues de réduction. Alésage 20 (20/16 + 20/12,7) et alésage 30 (30/16 + 30/20).

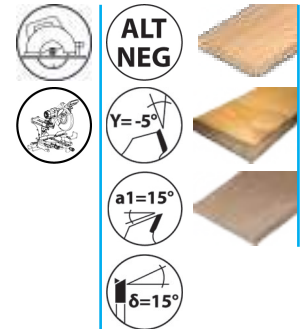

HM

EN847-1

BOIS, BOIS LATTÉ, CONTREPLAQUÉ

Ø	Alésage	Alésage	Z	REF	Code	€
160	20	2,5/1,6	48	964.160.2548	3510789642539	51,02
216	30	2,8/1,8	24	964.216.3024	3510789641723	44,59
216	30	2,8/1,8	48	964.216.3048	3510789641730	66,34
250	30	3,2/2,2	24	964.250.3024	3510789642478	82,47
250	30	3,2/2,2	48	964.250.3048	3510789642485	98,32
260	30	2,5/1,8	48	964.260.2548	3510789642713	102,58
260	30	2,5/1,8	60	964.260.2560	3510789642720	115,57
305	30	3,2/2,2	32	964.305.3032	3510789642591	85,92
305	30	3,2/2,2	60	964.305.3060	3510789642607	113,35

HM

EN847-1



LSC.964TK

LAME POUR LE BOIS MASSIF SUR MACHINES À BATTERIE

- Denture alternée pour bois.
- Épaisseur fine, limitant l'effort de coupe.
- Adaptée aux machines sans fil.
- Corps revêtu: réduction des frictions et protection préventive contre la corrosion.

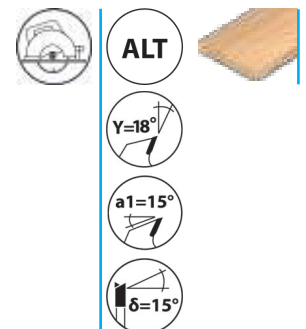

BOIS

Ø	Alésage	Alésage	Z	REF	Code	€
85	15	1,1/0,7	16	964TK.085.1516	3661589086693	26,50
136	20	1,6/1,0	24	964TK.136.2024	3661589086716	34,53
160	20	1,6/1,0	28	964TK.160.2028	3661589086723	38,29
190	30	1,6/1,0	32	964TK.190.3032	3661589086730	49,38

BOIS MASSIF



LSC.964BA

LAME TOUTES SCIÉS POUR LE BOIS MASSIF

- Denture alternée pour bois.
- Lames jusqu'à 235 mm livrées avec bagues de réduction. Alésage 20 (20/16 + 20/12,7) et alésage 30 (30/16 + 30/20).

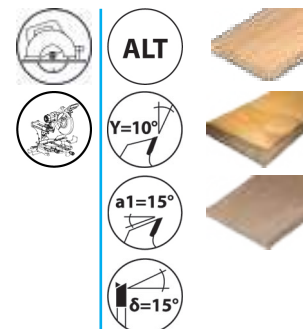

HM





EN847-1

BOIS, BOIS LATTÉ, CONTREPLAQUÉ





				REF		€
100	20	2,6/1,6	24	964.100.2024	3510789641006	30,68
120	20	1,8/1,2	24	964.120.2024	3510785435067	35,43
125	12,7	2,6/1,6	24	964.125.1224	3510789642256	33,12
125	20	2,6/1,6	24	964.125.2024	3510789641020	33,12
125	20	2,6/1,6	36	964.125.2036	3510789641037	40,85
130	16	2,6/1,6	24	964.130.1624	3510789641044	33,12
130	20	2,6/1,6	24	964.130.2024	3510789641068	33,12
130	20	2,6/1,6	36	964.130.2036	3510789641075	43,45
140	12,7	2,6/1,6	24	964.140.1224	3510789642218	33,12
140	20	2,6/1,6	24	964.140.2024	3510789641082	33,12
140	20	2,6/1,6	42	964.140.2042	3510789641099	56,17
150	20	2,6/1,6	24	964.150.2024	3510789641136	35,71
150	20	2,6/1,6	48	964.150.2048	3510789641150	49,73
150	30	2,6/1,6	24	964.150.3024	3510789641167	35,71
150	30	2,6/1,6	48	964.150.3048	3510789641181	49,73
160	16	2,6/1,6	24	964.160.1624	3510789641204	35,71
160	16	2,6/1,6	48	964.160.1648	3510789641228	49,73
160	20	1,8/1,2	24	964.160.1824	3510789641297	39,44
160	20	1,8/1,2	48	964.160.1848	3510789641396	53,36
160	20	2,2/1,6	24	964.160.2224	3661589043146	37,88
160	20	2,2/1,6	48	964.160.2248	3510789641990	54,87
160	20	2,2/1,6	60	964.160.2260	3661589086747	62,97
160	20	2,5/1,6	24	964.160.2024	3510789641235	35,71
160	20	2,5/1,6	48	964.160.2048	3510789641259	49,73
160	30	2,6/1,6	24	964.160.3024	3510789641273	35,71
160	30	2,6/1,6	48	964.160.3048	3510789641280	49,73
165	20	2,6/1,6	24	964.165.2024	3510785413768	39,39
165	20	2,6/1,6	48	964.165.2048	3510785413775	54,87
168	20	1,8/1,2	24	964.168.1824	3661589099778	39,44
168	20	1,8/1,2	48	964.168.1848	3661589099785	53,36

LAMES DE SCIE CIRCULAIRE

BOIS MASSIF

				REF		€
170	16	2,6/1,6	24	964.170.1624	3510789641303	37,02
170	16	2,6/1,6	48	964.170.1648	3510789642225	48,43
170	30	2,6/1,6	24	964.170.3024	3510789641365	37,02
170	30	2,6/1,6	48	964.170.3048	3510789641389	48,43
180	16	2,8/1,8	24	964.180.1624	3510789641402	38,26
180	16	2,8/1,8	48	964.180.1648	3510789641426	49,73
180	20	2,8/1,8	24	964.180.2024	3510789641433	38,26
180	20	2,8/1,8	48	964.180.2048	3510789641457	49,73
180	30	2,8/1,8	24	964.180.3024	3510789641471	38,26
180	30	2,8/1,8	48	964.180.3048	3510789641495	49,73
185	20	2,4/1,4	24	964.185.2424	3661589099792	38,26
185	20	2,4/1,4	48	964.185.2448	3661589099808	49,73
190	16	2,8/1,8	24	964.190.1624	3510789641501	39,56
190	16	2,8/1,8	48	964.190.1648	3510789641518	62,50
190	20	2,8/1,8	24	964.190.2024	3510789641532	39,56
190	20	2,8/1,8	48	964.190.2048	3510789641549	62,50
190	étoile	2,5/1,6	24	964.190.2524	3510789642676	37,12
190	étoile	2,5/1,6	48	964.190.2548	3510789642683	60,28
190	30	2,8/1,8	24	964.190.3024	3510789641570	39,56
190	30	2,8/1,8	48	964.190.3048	3510789641587	62,50
200	15	2,8/1,8	24	964.200.1524	3510789642362	40,85
200	15	2,8/1,8	48	964.200.1548	3510789642379	61,20
200	30	2,8/1,8	24	964.200.3024	3510789641600	40,85
200	30	2,8/1,8	48	964.200.3048	3510789641617	61,20
200	30	2,8/1,8	64	964.200.3064	3510789641624	77,82
210	30	2,8/1,8	24	964.210.3024	3510789641679	44,59
210	30	2,8/1,8	48	964.210.3048	3510789641686	67,65
210	30	2,8/1,8	64	964.210.3064	3510789641709	81,71
220	30	2,8/1,8	24	964.220.3024	3510789641754	44,59
220	30	2,8/1,8	48	964.220.3048	3510789641761	70,07
220	30	2,8/1,8	64	964.220.3064	3510789641778	84,14
225	30	2,5/1,8	32	964.225.3032	3661589079169	66,82
225	30	2,5/1,8	48	964.225.3048	3661589079176	83,43
230	30	2,8/1,8	24	964.230.3024	3510789641808	45,89
230	30	2,8/1,8	48	964.230.3048	3510789641815	73,97
230	30	2,8/1,8	64	964.230.3064	3510789641822	84,14
235	16	2,8/1,8	24	964.235.1624	3510789641846	45,89
235	16	2,8/1,8	48	964.235.1648	3510789641853	73,97
235	30	2,8/1,8	24	964.235.3024	3510789642157	45,89
235	30	2,8/1,8	48	964.235.3048	3510789642164	73,97
235	30	2,8/1,8	64	964.235.3064	3510789642454	84,14

BOIS MASSIF

				REF		€
240	30	3,0/2,0	24	964.240.3024	3510789641907	48,43
240	30	3,0/2,0	48	964.240.3048	3510789641914	76,56
255	30	3,2/2,2	24	964.255.3024	3510789642638	81,98
255	30	3,2/2,2	40	964.255.3040	3510789642645	98,32
255	30	3,2/2,2	60	964.255.3060	3510789642652	115,57
260	30	3,2/2,2	24	964.260.3024	3510789641945	81,98
260	30	3,2/2,2	40	964.260.3040	3510789641952	98,32
260	30	3,2/2,2	60	964.260.3060	3510789641969	115,57
270	30	3,2/2,2	24	964.270.3024	3510789642249	81,98
270	30	3,2/2,2	40	964.270.3040	3510789642232	110,54
280	30	3,2/2,2	28	964.280.3028	3510789642010	85,55
280	30	3,2/2,2	48	964.280.3048	3510789642027	107,73
280	30	3,2/2,2	68	964.280.3068	3510789642034	120,50
315	30	3,2/2,3	28	964.315.3028	3510789641891	83,76
330	30	3,2/2,2	24	964.330.3024	3661589079190	78,59
330	30	3,2/2,2	40	964.330.3040	3661589079206	90,78
335	30	3,2/2,3	36	964.335.3036	3510789642065	91,50
355	30	3,2/2,3	24	964.355.3024	3510789642089	91,50
355	30	3,2/2,3	40	964.355.3040	3510789642096	130,13
410	30	3,6/2,6	28	964.410.3028	3510789641792	134,03
415	30	3,6/2,6	36	964.415.3036	3510789642119	136,08

LAMES DE SCIE CIRCULAIRE

PANNEAUX ET DÉRIVÉS DU BOIS



LSC.E64TF

LAME DE SCIE CIRCULAIRE POUR MACHINES PORTATIVES

- Lame haute performance pour la coupe du bois et panneaux dérivés.
- Travail de finition.



EN847-1

PARQUET, HPL (STRATIFIÉ SOUS HAUTE PRESSION), MÉLAMINÉ, STRATIFIÉ, MDF/HDF

Epaisseur 2,2 sans rivet cuivre.

				REF		€
160	20	2,2/1,6	48	GOLD64.16047TF	3661589079022	68,29
160	20	2,5/1,8	48	GOLD64.16048TF	3510785433780	68,29



LSC.964TF

LAME DE SCIE CIRCULAIRE POUR MACHINES PORTATIVES

- Travail de finition.



EN847-1

PARQUET, HPL (STRATIFIÉ SOUS HAUTE PRESSION), MÉLAMINÉ, STRATIFIÉ, MDF/HDF

				REF		€
120	20	1,8/1,2	40	964TF.120.40	3510785435074	55,47
160	20	2,2/1,6	48	964TF.160.47	3510785402014	68,02
160	20	2,5/1,6	48	964TF.160.48	3510789642553	63,25



LSC.E0003

LAME DE MISE À FORMAT DE PANNEAUX DÉRIVÉS DU BOIS

- Lame pour bois naturels, bois tendres, durs et exotiques.
- Panneaux plaqués une face ou stratifiés jusqu'à 30 mm de hauteur de coupe.
- Tôle silencieuse avec découpes laser.
- Plaquettes carbure micro-grain.



EN847-1

BOIS, BOIS LATTÉ, CONTREPLAQUÉ, AGGLOMÉRÉ

Trous d'ergots combinés 2/7/42 + 2/9/46,4 + 2/10/60

				REF		€
250	30	3,2/2,2	64	GOLD3.2503060	3510786000110	106,60
250	30	3,2/2,2	72	GOLD3.2503080	3510786000127	128,40
300	30	3,2/2,2	72	GOLD3.3003072	3510786000134	131,10
300	30	3,2/2,2	96	GOLD3.3003096	3510786000141	148,91
350	30	3,6/2,5	108	GOLD3.3503010	3510786000158	188,52

PANNEAUX ET DÉRIVÉS DU BOIS



LSC.00338

LAME DE MISE À FORMAT DE PANNEAUX DÉRIVÉS DU BOIS

- Utilisation universelle coupe en long et en travers pour les bois tendres, durs et exotiques ainsi que pour les panneaux plaqués une face ou stratifiés.

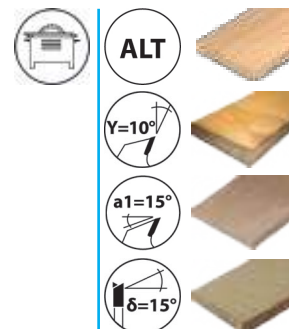

HM

EN847-1

BOIS, BOIS LATTÉ, CONTREPLAQUÉ, AGGLOMÉRÉ

Trous d'ergots combinés 2/7/42 + 2/9/46,4 + 2/10/60

				REF		€
250	30	3,2/2,2	60	336.250.3060	3510783361009	87,81
250	30	3,2/2,2	80	338.250.3080	3510783381007	96,21
300	30	3,2/2,2	72	336.300.3072	3510783361016	86,64
300	30	3,2/2,2	96	338.300.3096	3510783381021	106,08
315	30	3,2/2,2	72	336.315.3072	3510783361054	115,57
315	30	3,2/2,2	96	338.315.3096	3510783381113	122,36
350	30	3,5/2,5	84	336.350.3084	3510783361023	114,48
350	30	3,5/2,5	108	338.350.3010	3510783381038	153,29
400	30	3,5/2,5	96	336.400.3096	3510783361030	183,86
400	30	3,5/2,5	120	338.400.3012	3510783381052	212,70
450	30	4,0/2,8	108	336.450.3010	3510783361047	259,49
500	30	4,0/2,8	144	338.500.3014	3510783381069	316,09

PANNEAUX ET DÉRIVÉS DU BOIS



LSC.E04TF

LAME DE MISE À FORMAT DE PANNEAUX DÉRIVÉS DU BOIS

- Lame de débit.
- Qualité de coupe optimale dans les panneaux massifs en matière plastique (thermoplastique et duroplastique), stratifiés et MDF.
- Tôle silencieuse avec découpes laser.
- Plaquettes carbure micro-grain.

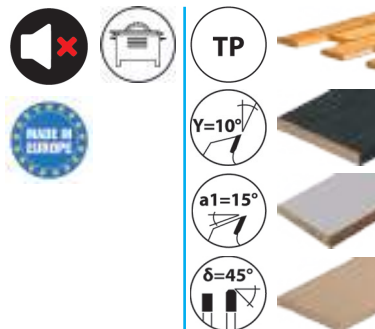

HM
MICROGRAIN

EN847-1

PARQUET, HPL (STRATIFIÉ SOUS HAUTE PRESSION), MÉLAMINÉ, STRATIFIÉ, MDF/HDF

Trous d'ergots combinés 2/7/42 + 2/9/46,4 + 2/10/60

				REF		€
250	30	3,2/2,2	60	GOLD4.2503060	3510786000172	114,76
250	30	3,2/2,2	80	GOLD4.2503080	3510786000189	135,27
300	30	3,2/2,2	72	GOLD4.3003072	3510786000196	139,37
300	30	3,2/2,2	96	GOLD4.3003096	3510786000202	161,19
350	30	3,6/2,5	108	GOLD4.3503010	3510786000219	210,36



LSC.ET4TF

LAME DE MISE À FORMAT DE PANNEAUX DÉRIVÉS DU BOIS

- Lame pour le débit et la mise à format des panneaux 1 ou 2 faces.
- Qualité de coupe optimale dans les panneaux massifs en matière plastique (thermoplastique et duroplastique), stratifiés.
- Tôle silencieuse avec découpes laser.
- Revêtement Téflon: réduction des frictions et protection préventive optimale contre la corrosion.

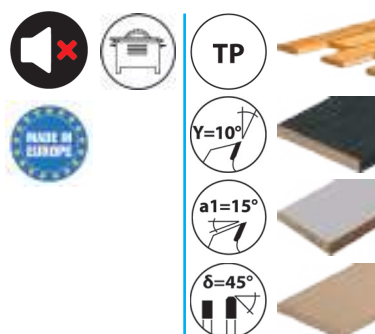

HM
TEFLON

EN847-1

PARQUET, HPL (STRATIFIÉ SOUS HAUTE PRESSION), MÉLAMINÉ, STRATIFIÉ, MDF/HDF

Trous d'ergots combinés 2/7/42 + 2/9/46,4 + 2/10/60

				REF		€
250	30	3,2/2,2	80	364TP25080	3510783640029	120,44
300	30	3,2/2,2	72	364TP30072	3510783640036	124,07
300	30	3,2/2,2	96	364TP30096	3510783640043	144,52

PANNEAUX ET DÉRIVÉS DU BOIS



LSC.338TF

LAME DE MISE À FORMAT DE PANNEAUX DÉRIVÉS DU BOIS

- Pour le débit et la mise à format des panneaux 1 ou 2 faces, jusqu'à 30 mm de hauteur de coupe.
- Qualité de coupe optimale dans les panneaux massifs en matière plastique (thermoplastique et duroplastique), stratifiés.

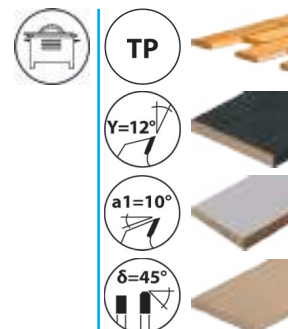

HM

EN847-1

PARQUET, HPL (STRATIFIÉ SOUS HAUTE PRESSION), MÉLAMINÉ, STRATIFIÉ, MDF/HDF

Trous d'ergots combinés 2/7/42 + 2/9/46,4 + 2/10/60

				REF		€
200	30	3,2/2,2	64	338TF.200.64	3510783382042	85,38
220	30	3,2/2,2	64	338TF.220.64	3510783382004	105,72
250	30	3,2/2,2	60	336TF.250.60	3510783362006	102,20
250	30	3,2/2,2	80	338TF.250.80	3510783382011	108,21
300	30	3,2/2,2	72	336TF.300.72	3510783362013	111,74
300	30	3,2/2,2	96	338TF.300.96	3510783382028	129,75
315	30	3,2/2,2	72	336TF.315.72	3510783363003	121,31
315	30	3,2/2,2	96	338TF.315.96	3510783382059	150,27
350	30	3,5/2,5	84	336TF.350.84	3510783362020	162,32
350	30	3,5/2,5	108	338TF.350.10	3510783382035	195,87

PANNEAUX ET DÉRIVÉS DU BOIS



LSC.00356 INCISEUR EXTENSIBLE

- Pour inciser la face inférieure des panneaux stratifiés.
- Inciseur extensible avec bagues millimétriques fournies.



MÉLAMINÉ, STRATIFIÉ, MDF/HDF, HPL (STRATIFIÉ SOUS HAUTE PRESSION)

HM

EN847-1

Ø	⌀	⊕/⊖	⌒	REF	🔍	€
80	20	2,8-3,6/2x2,0	2x10	356.080.20210	3510783561003	76,13
100	20	2,8-3,6/2x2,0	2x12	356.100.20212	3510783561027	76,78
100	22	2,8-3,6/2x2,0	2x12	356.100.22212	3510783561034	76,78
120	20	2,8-3,6/2x2,0	2x12	356.120.20212	3510783561041	76,78
120	22	2,8-3,6/2x2,0	2x12	356.120.22212	3510783561058	76,78
JEU 4 BAGUES D'EXTENSION POUR INCISEUR 356 AL20/22		20/22	0,1x1/0,2x2/0,3x1	356.000.22000	3510785417001	19,00



LSC.00357 INCISEUR CONIQUE

- Pour inciser la face inférieure des panneaux stratifiés.



MÉLAMINÉ, STRATIFIÉ, MDF/HDF, HPL (STRATIFIÉ SOUS HAUTE PRESSION)

HM

EN847-1

Ø	⌀	⊕/⊖	⌒	REF	🔍	€
80	20	2,8-3,8/2,0	12	357.080.2012	3510783571132	56,50
100	20	3,1-4,3/2,2	18	357.100.2018	3510783571019	56,50
100	22	3,1-4,3/2,2	18	357.100.2218	3510783571088	56,50
110	20	3,1-4,3/2,2	20	357.110.2020	3510783571026	57,30
120	20	3,1-4,2/2,0	24	357.120.2024	3510783571033	57,30
120	22	3,1-4,2/2,0	24	357.120.2224	3510783571095	57,30
125	20	3,1-4,2/2,2	24	357.125.2024	3510783571040	57,30

PANNEAUX ET DÉRIVÉS DU BOIS



LSC.E0005

LAME DE MISE À FORMAT DE PANNEAUX MÉLAMINÉS ET STRATIFIÉS

- Lame pour la découpe des panneaux plaqués thermoplastiques, duroplastiques polyester.
- Panneaux revêtus jusqu'à 50 mm de hauteur de coupe et MDF.
- Tôle silencieuse avec découpes laser.
- Plaquettes carbure micro-grain.
- Utilisation possible sans inciseur.

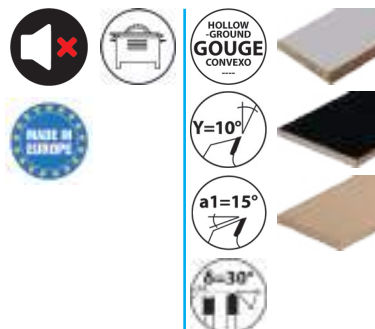

MÉLAMINÉ, STRATIFIÉ, MDF/HDF

Trous d'ergots combinés 2/7/42 + 2/9/46,4 + 2/10/60

				REF		€
250	30	3,2/2,2	48	GOLD5.2503048	3510786000233	142,09
303	30	3,2/2,2	60	GOLD5.3033061	3510786000257	158,43

HM
MICROGRAIN

EN847-1



LSC.E0005N

LAME DE MISE À FORMAT DE PANNEAUX MÉLAMINÉS ET STRATIFIÉS

- Lame pour la découpe des panneaux plaqués thermoplastiques, duroplastiques polyester.
- Panneaux revêtus jusqu'à 50 mm de hauteur de coupe et MDF.
- Tôle silencieuse avec découpes laser.
- Plaquettes carbure micro-grain.
- Utilisation possible sans inciseur.

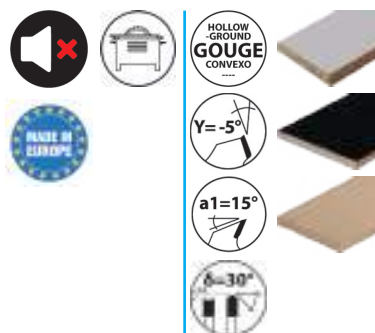

MÉLAMINÉ, STRATIFIÉ, MDF/HDF

Trous d'ergots combinés 2/7/42 + 2/9/46,4 + 2/10/60

				REF		€
303	30	3,2/2,2	60	GOLD5.3033060	3510786000240	158,43

HM
MICROGRAIN

EN847-1

PANNEAUX ET DÉRIVÉS DU BOIS



LSC.00354

LAME DE MISE À FORMAT DE PANNEAUX MÉLAMINÉS ET STRATIFIÉS

- Excellente qualité de coupe dans les panneaux plaqués thermoplastiques, duroplastiques polyester.
- Panneaux revêtus jusqu'à 50 mm de hauteur de coupe.
- Utilisation possible sans inciseur.

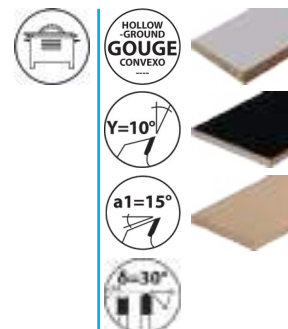

HM

EN847-1

MÉLAMINÉ, STRATIFIÉ, MDF/HDF

Trous d'ergots combinés 2/7/42 + 2/9/46,4 + 2/10/60

				REF		€
220	30	3,2/2,2	40	354.220.3040	3510783541005	115,46
250	30	3,2/2,2	48	354.250.3048	3510783541012	122,55
300	30	3,2/2,2	72	354.300.3072	3510783541043	167,09
303	30	3,2/2,2	60	354.303.3061	3510783541036	127,42
350	30	3,5/2,5	72	354.350.3072	3510783541050	203,11
400	30	3,2/2,2	84	354.400.3084	3510783541067	234,40



LSC.00354N

LAME DE MISE À FORMAT DE PANNEAUX MÉLAMINÉS ET STRATIFIÉS

- Excellente qualité de coupe dans les panneaux plaqués thermoplastiques, duroplastiques polyester.
- Panneaux revêtus jusqu'à 50 mm de hauteur de coupe.
- Utilisation possible sans inciseur.

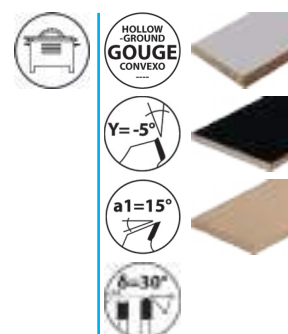

HM

EN847-1

MÉLAMINÉ, STRATIFIÉ, MDF/HDF

Trous d'ergots combinés 2/7/42 + 2/9/46,4 + 2/10/60

				REF		€
303	30	3,2/2,2	60	354.303.3060	3510783541029	127,42

PANNEAUX ET DÉRIVÉS DU BOIS



HM

EN847-1

LSC.LAM.LSC938HM

LAME POUR ASSEMBLAGE A LAMELLE

- Lame à rainer en carbure brasé.
- Forme anti-rejet.
- Corps plat.

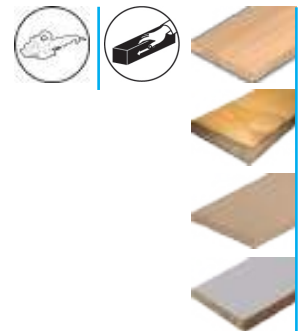

BOIS, BOIS LATTÉ, CONTREPLAQUÉ, MDF/HDF, MÉLAMINÉ, MATIÈRES PLASTIQUES

			REF		€
100	22	3,96	938.7.100.22.12	3510789381001	43,29



HM

EN847-1

LSC.LAM.FR0938HM

FRAISE POUR ASSEMBLAGE A LAMELLE

- Fraise à rainer en carbure brasé.
- Forme anti-rejet.
- Corps usiné avec moyeu renforcé.

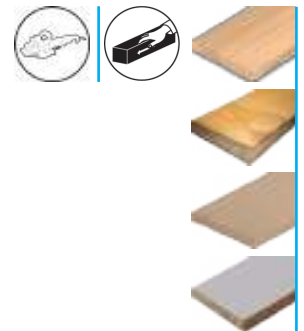

BOIS, BOIS LATTÉ, CONTREPLAQUÉ, MDF/HDF, MÉLAMINÉ

			REF		€
100	22	3,96	938.7.100.22.24	3510789381018	81,16



HM
PLAQUETTES

EN847-1

LSC.LAM.PO0938HM

P.O. POUR ASSEMBLAGE A LAMELLE

- Porte-outils à plaquettes carbure réversibles.
- Forme anti-rejet.
- Corps usiné avec moyeu renforcé.

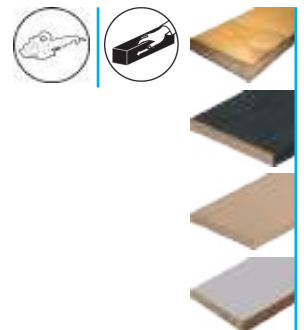

BOIS LATTÉ, CONTREPLAQUÉ, HPL (STRATIFIÉ SOUS HAUTE PRESSION), MDF/HDF, MÉLAMINÉ

RECHANGE : PLAQUETTES CROCHET 0018.1819.00 - PLAQUETTES 02.2171.4

			REF		€
100	22	3,96	938.9.100.22.44	3510789381032	146,09

MULTI-MATÉRIAUX



LSC.00923

LAME MULTI-MATÉRIAUX POUR ÉLECTRO-PORTATIF ET SCIE À ONGLET

- Sciage propre des matériaux les plus variés (bois, bois clouté, panneaux dérivés du bois, profilé aluminium, profilé acier mince, rond acier $\varnothing 10$ max, profilé PVC, carton...)
- Plaquettes carbure et géométries spécifiques.
- Corps revêtu limitant les frictions et les résidus de coupe.

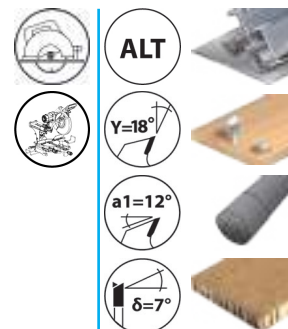

HM

EN847-1

BOIS, BOIS CLOUTÉ, ALUMINIUM, ACIER, PVC, AGGLOMÉRÉ, CARTON

				REF		€
160	20	2,0/1,4	52	923.160.2052	3661589088543	74,91
190	30	2,0/1,4	55	923.190.3055	3661589088574	96,24
216	30	2,0/1,4	80	923.216.3080	3661589088581	129,86
255	30	2,2/1,6	100	923.255.3010	3661589088604	150,13
305	30	2,4/1,8	120	923.305.3012	3661589088611	166,31



LSC.00355

LAME DE DÉBIT POUR MATÉRIAUX PLASTIQUES

- Pour le débit de résines synthétiques jusqu'à 10 mm de hauteur de coupe.
- Épaisseur fine.

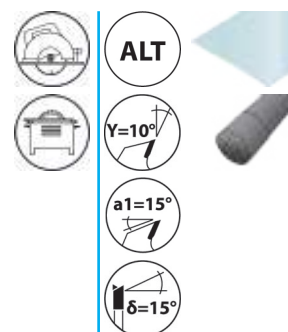

HM

EN847-1

PLEXIGLASS, PVC

				REF		€
150	30	2,4/1,6	48	355.150.3048	3510783551004	98,53
180	30	2,4/1,6	56	355.180.3056	3510783551011	110,49
200	30	2,4/1,6	64	355.200.3064	3510783551028	127,42
250	30	2,4/1,6	80	355.250.3080	3510783551035	151,50
300	30	2,4/1,6	96	355.300.3096	3510783551042	171,84
350	30	2,4/1,6	108	355.350.3010	3510783551059	216,32

LAMES DE SCIE CIRCULAIRE

MULTI-MATÉRIAUX



HM

EN847-1

LSC.223BA

LAME DE SCIE DE CHANTIER MULTI-MATÉRIAUX

- Épaisseur fine.

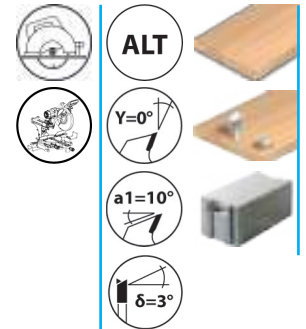

BOIS, BOIS CLOUTÉ, BÉTON CELLULAIRE, FIBRO CIMENT

Ø	mm	mm	mm	REF	REF	€
160	20	1,8/1,35	18	223.160.2018	3661589042224	46,53
190	30	1,8/1,35	20	223.190.3020	3661589042248	50,33
216	30	2,0/1,6	24	223.216.3024	3661589042255	60,61
230	30	2,0/1,6	24	223.230.3024	3661589042262	62,77
252	30	2,2/1,8	28	223.252.3028	3661589042279	79,00



HM

EN847-1

LSC.223TF

LAME DE SCIE DE CHANTIER SPÉCIALE PALETTE

- Lame de débit.

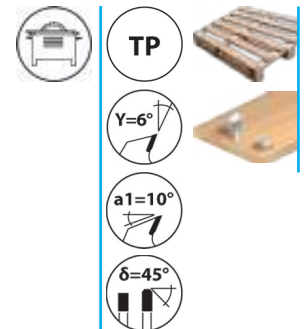

BOIS DE PALETTE, BOIS CLOUTÉ

Trous d'ergots combinés 2/7/42 + 2/9/46,4 + 2/10/60

Ø	mm	mm	mm	REF	REF	€
300	30	3,2/2,2	20	223.300.3024	3510782231006	73,43
315	30	3,2/2,2	20	223.315.3020	3510782231013	75,86
350	30	3,6/2,5	24	223.350.3024	3510782231020	84,19
400	30	3,6/2,5	28	223.400.3028	3510782231037	91,38
450	30	4,0/2,8	32	223.450.3032	3510782231105	122,55
500	30	4,0/2,8	36	223.500.3036	3510782231112	156,32

MULTI-MATÉRIAUX



LSC.00224

LAME DE SCIE DE CHANTIER MULTI-MATÉRIAUX

- Utilisation pour bois y compris avec clous et agrafes, restes de béton.
- Convient également pour les plastiques, plexiglas, profilés alu (ne coupe pas les métaux).

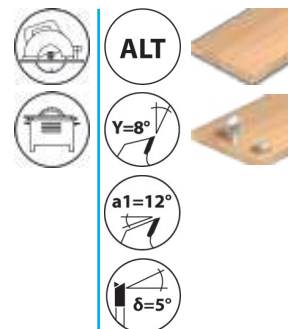

HM

EN847-1

BOIS, BOIS DE COFFRAGE, BOIS CLOUTÉ

Ø	⌀	⊕	⊖	REF	ISB	€
150	20	2,8/1,6	24	224.150.2024	3510782241005	56,60
160	20	2,8/1,6	24	224.160.2024	3510782241012	58,93
180	30	2,8/1,8	30	224.180.3030	3510782241036	67,37
190	30	2,8/1,8	30	224.190.3030	3510782241043	69,64
210	30	2,8/1,8	32	224.210.3034	3510782241067	76,94
230	30	2,8/1,8	34	224.230.3034	3510782241074	82,95
250	30	3,0/2,0	42	224.250.3042	3510782241104	102,20
300	30	3,2/2,2	48	224.300.3048	3510782241111	115,46
315	30	3,2/2,2	48	224.315.3048	3510782241128	126,24
350	30	3,2/2,2	54	224.350.3054	3510782241135	133,43
400	30	3,5/2,5	64	224.400.3060	3510782241142	149,01
450	30	3,5/2,5	66	224.450.3066	3510782241159	192,30
500	30	4,0/2,8	72	224.500.3072	3510782241166	243,96
600	30	4,2/2,9	78	224.600.3078	3510782241173	282,49

MULTI-MATÉRIAUX

CLASSIC



LSC.DI350PL

LAME DE SCIE CIRCULAIRE DIAMANT

- Découpe de matériaux abrasifs et composites.
- Plaquettes diamant hauteur 3 mm.
- Tôle silencieuse avec découpes laser.
- Revêtement Téflon: réduction des frictions et protection préventive optimale contre la corrosion.

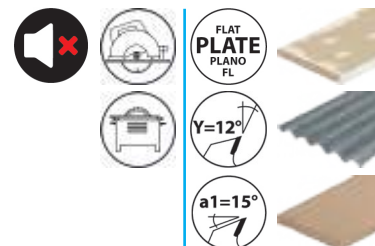

FIBRO CIMENT, MATÉRIAUX BASE CIMENT, PLÂTRE, MDF/HDF

Alésage 20 trous d'ergots 2/6/32

Alésage 30 trous d'ergots 2/7/42

Trous d'ergots combinés 2/7/42 + 2/9/46,4 + 2/10/60 sur Ø 250 et 300 mm



EN847-1

Ø	Alésage	Alésage	Alésage	Alésage	REF	REF	€
160	20	2,2/1,7	8	8400	3501602008	3510785401482	162,48
190	30	2,2/1,7	8	7000	3501903008	3510785402120	166,05
210	30	2,2/1,7	12	6400	3502103012	3510785402137	212,48
230	30	2,2/1,7	15	5800	3502303015	3510785402144	249,98
250	30	3,0/2,5	16	5400	3502503016	3510785402151	264,22
300	30	3,0/2,5	48	4450	3503003048	3510785402175	807,68

CLASSIC



LSC.DI350BA

LAME DE SCIE CIRCULAIRE DIAMANT

- Découpe de matériaux abrasifs et composites.
- Plaquettes diamant hauteur 3 mm.
- Tôle silencieuse avec découpes laser.
- Revêtement Téflon: réduction des frictions et protection préventive optimale contre la corrosion.

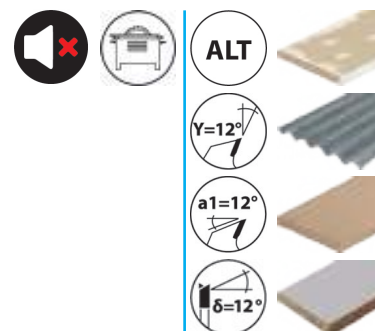

FIBRO CIMENT, MATÉRIAUX BASE CIMENT, PLÂTRE, MDF/HDF, MÉLAMINÉ

Trous d'ergots combinés 2/7/42 + 2/9/46,4 + 2/10/60



EN847-1

Ø	Alésage	Alésage	Alésage	Alésage	REF	REF	€
300	30	3,0/2,2	72	4450	3503003072	3510785435920	1020,22

MULTI-MATÉRIAUX



EXPERT

LSC.E0123S

LAME DE DÉCOUPE MULTI-MATÉRIAUX

- Lame pour la coupe des métaux ferreux et non ferreux, profilé, tôle métallique, tuyau métallique, cornière, plastique, matériau composite, bois et panneaux sandwich.
- Tôle silencieuse avec découpes laser.
- Revêtement Téflon: réduction des frictions et protection préventive optimale contre la corrosion.
- Pastille céramique-métal: alliage haute résistance pour une plus grande longévité et une coupe multi-matériaux.



EN847-1

MÉTAL, ALUMINIUM, MATÉRIAUX BASE BOIS, MATÉRIAUX MULTI-COUCHES OU SANDWICH

					REF		€
160	20	1,8/1,4	40	5200	123.160.2040	3510785416714	99,89
190	30	1,8/1,4	48	5200	123.190.3048	3510785416721	128,30
210	30	1,9/1,4	48	5000	123.210.3048	3510785416738	149,99
216	30	1,9/1,4	48	5000	123.216.3048	3510785416745	173,09

Respecter la vitesse maximale indiquée.



EXPERT

LSC.E0123M

LAME DE DÉCOUPE MULTI-MATÉRIAUX

- Lame pour la coupe des métaux ferreux et non ferreux, profilé, tôle métallique, tuyau métallique, cornière, plastique, matériau composite, bois et panneaux sandwich.
- Tôle silencieuse avec découpes laser.
- Revêtement Téflon: réduction des frictions et protection préventive optimale contre la corrosion.
- Pastille céramique-métal: alliage haute résistance pour une plus grande longévité et une coupe multi-matériaux.

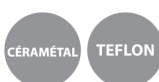

EN847-1

MÉTAL, ALUMINIUM, MATÉRIAUX BASE BOIS, MATÉRIAUX MULTI-COUCHES OU SANDWICH

					REF		€
230	30	2,0/1,4	48	5000	123.230.3048	3510785416752	195,71
255	30	2,0/1,4	48	5000	123.255.3048	3510785416769	214,54

Respecter la vitesse maximale indiquée.



EXPERT

LSC.E0123L

LAME DE DÉCOUPE MULTI-MATÉRIAUX

- Lame pour la coupe des métaux ferreux et non ferreux, profilé, tôle métallique, tuyau métallique, cornière, plastique, matériau composite, bois et panneaux sandwich.
- Tôle silencieuse avec découpes laser.
- Revêtement Téflon: réduction des frictions et protection préventive optimale contre la corrosion.
- Pastille céramique-métal: alliage haute résistance pour une plus grande longévité et une coupe multi-matériaux.



EN847-1

MÉTAL, ALUMINIUM, MATÉRIAUX BASE BOIS, MATÉRIAUX MULTI-COUCHES OU SANDWICH

					REF		€
305	30/25	2,2/1,9	56	1700	123.305.3056	3510785435043	237,64
355	30/25	2,3/1,9	66	1500	123.355.3066	3510785435050	269,68

Respecter la vitesse maximale indiquée.

MÉTAL



LSC.E0009BA

LAME DE DÉCOUPE DE MÉTAUX INOXYDABLES

- Lame Dry cutter haute performance pour la coupe de tous les matériaux inox.
- Tôle silencieuse avec découpes laser.
- Plaquettes carbure micrograin.

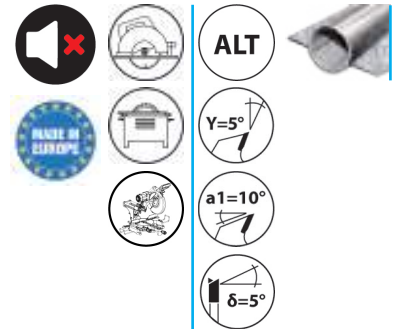

HM
MICROGRAIN
EN847-1

ACIER INOXYDABLE

Ø	mm	mm	mm	mm	REF	REF	€
160	20	1,6/1,35	40	3800	GOLD9.1602040	3661589042293	103,13
190	30	1,6/1,35	48	3200	GOLD9.1903048	3661589042309	127,69
216	30	2,0/1,6	54	2800	GOLD9.2163054	3661589042316	143,61
230	30	2,0/1,6	56	2600	GOLD9.2303056	3661589042323	151,66

Non appropriée pour la coupe de l'acier. Respecter la vitesse maximale indiquée.



LSC.E0009TP

LAME DE DÉCOUPE DE MÉTAUX INOXYDABLES

- Lame Dry cutter haute performance pour la coupe de tous les matériaux inox.
- Tôle silencieuse avec découpes laser.
- Plaquettes carbure micrograin.

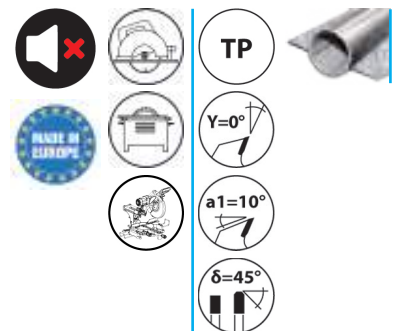

HM
MICROGRAIN
EN847-1

ACIER INOXYDABLE

Ø	mm	mm	mm	mm	REF	REF	€
250	30	2,2/1,8	60	2400	GOLD9.2503060	3510785401383	181,48
305	25,4	2,2/1,8	72	2000	GOLD9.3052572	3510785401406	223,07
320	25,4	2,2/1,8	84	1900	GOLD9.3202584	3661589079039	281,56
355	25,4	2,4/2,0	84	1700	GOLD9.3552590	3510785401413	310,24

Non appropriée pour la coupe de l'acier. Respecter la vitesse maximale indiquée.

MÉTAL

EXPERT



LSC.E0011

LAME DE DÉCOUPE À SEC DES MÉTAUX FERREUX

- Lame pour la découpe de cornières, tubes métalliques, tôles, tubes carrés, fers plats, fers ronds, profilés métalliques, panneaux sandwich.
- Longévité de coupe accrue grâce à sa conception et un traitement spécifique.
- Tôle silencieuse avec découpes laser.
- Plaquettes carbure micro-grain.

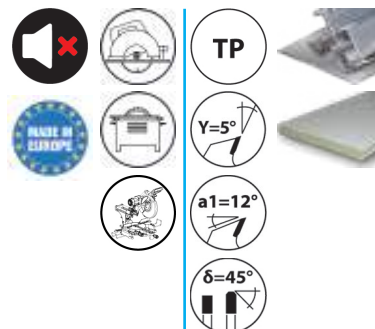

HM
MICROGRAIN

EN847-1

MÉTAL, ACIER, MATÉRIaux MULTI-COUCHES OU SANDWICH

Ø	Ø	Ø	Ø	Ø	REF	Ø	€
300	30	2,2/1,8	60	1500	GOLD11.3003060	3510785435005	178,29
305	25,4	2,2/1,8	60	1500	GOLD11.3052560	3510785435012	178,29
320	25,4	2,2/1,8	72	1900	GOLD11.3202572	3661589079046	222,73
350	30	2,4/2,0	72	1200	GOLD11.3503072	3510785435029	224,05
355	25,4	2,4/2,0	72	1200	GOLD11.3552572	3510785435036	224,05

Respecter la vitesse maximale indiquée.

EXPERT



LSC.ET007

LAME DE DÉCOUPE DE MÉTAUX NON-FERREUX

- Lame pour la coupe de profilés aluminium minces, profilés plastiques, cadres et tôles alu.
- Avance manuelle.
- Tôle silencieuse avec découpes laser.
- Revêtement Téflon: réduction des frictions et protection préventive optimale contre la corrosion.

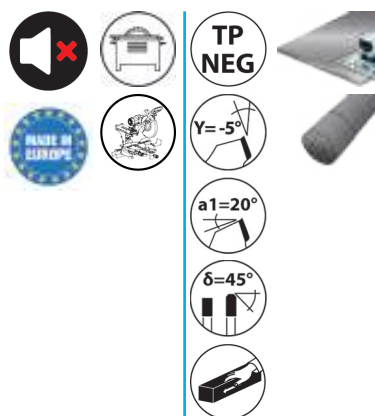

HM **TEFLON**

EN847-1

ALUMINIUM, MÉTAUX NON FERREUX, PVC

Trous d'ergots combinés 2/10/60 + 2/11/63 + 2/12/64

Ø	Ø	Ø	Ø	REF	Ø	€
300	30	3,2/2,5	96	364AL30096N	3510783640050	156,59

MÉTAL



LSC.00120

LAME DE DÉCOUPE À SEC DES MÉTAUX FERREUX

- Pour cornières, tubes métalliques, tôles, tubes carrés, fers plats, fers ronds, profilés métalliques, panneaux sandwich.
- Sur machines portatives et stationnaires, dry cutter à vitesse de rotation basse.
- Coupe rapide à sec, propre, sans étincelle, sans échauffement.

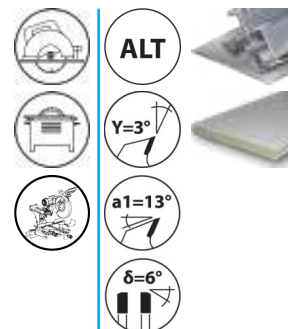

MÉTAL, ACIER, MATÉRIAUX MULTI-COUCHEs OU SANDWICH

HM

EN847-1

Ø	•	⊕	∠	∠	REF	IS	€
136	20	1,5/1,2	30	3000	120.136.2030	3661589079138	57,48
160	20	2,2/1,6	30	3000	120.160.2030	3510781202038	61,46
180	20	2,2/1,6	36	3000	120.180.2034	3510781202052	79,92
180	30	2,2/1,6	36	3000	120.180.3034	3510781202069	79,92
190	30	2,4/1,8	38	3000	120.190.3038	3510781202083	82,14
210	30	2,4/1,8	40	2300	120.210.3040	3510781202106	85,66
216	30	2,4/1,8	40	2300	120.216.3040	3510781202113	88,72
230	30	2,4/1,8	44	2000	120.230.3044	3510781202120	92,19
250	30	2,4/2,0	48	1750	120.250.3048	3510781202137	100,40
300	30	2,4/2,0	60	1500	120.300.3060	3510781202151	127,70
300	30	2,4/2,0	80	1200	120.300.3080	3510781202168	162,54
305	25,4	2,4/2,0	60	1500	120.300.2560	3510781202144	112,68
305	25,4	2,4/2,0	80	1200	120.300.2580	3510781202175	143,42
350	30	2,6/2,2	80	1200	120.350.3080	3510781202182	165,00
355	25,4	2,6/2,2	80	1200	120.355.2580	3510781202205	174,14

Respecter la vitesse maximale indiquée.



LSC.112AL

LAME DE DÉCOUPE DE MÉTAUX NON-FERREUX

- Pour la coupe de profilés aluminium minces, profilés plastiques, cadres et tôles alu.
- Avance manuelle.
- Scie à mouvement radial.

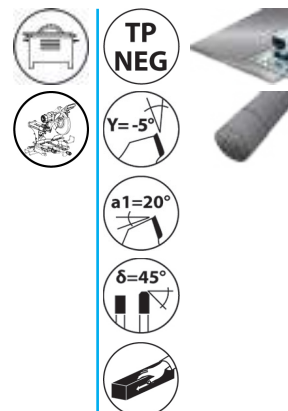

HM

EN847-1

ALUMINIUM, MÉTAUX NON FERREUX, PVC

Alésage 40 : Trous d'ergots 2/9/55 + 4/12/64
Trous d'ergots combinés 2/10/60 + 2/11/63 + 2/12/64

Ø	⌀	⊕	⊖	REF	Ⓜ	€
250	30	3,2/2,5	60	110.250.3060	3510781121001	126,34
250	30	3,2/2,2	80	112.250.3080	3510781121032	104,75
250	32	3,2/2,5	80	112.250.3280	3510781121049	147,45
250	30	3,2/2,5	96	114.250.3096	3510781140019	164,97
275	40	3,2/2,5	88	112.275.4088	3510781121070	212,26
300	30	3,2/2,5	72	110.300.3072	3510781121087	147,45
300	30	3,2/2,5	96	112.300.3096	3510781121100	132,51
300	32	3,2/2,5	96	112.300.3296	3510781121117	177,58
315	30	3,2/2,5	96	112.315.3096	3510781121360	190,24
330	30	3,2/2,5	96	112.330.3096	3510781121148	183,86
330	32	3,2/2,5	96	112.330.3296	3510781121155	183,86
350	30	3,4/2,8	84	110.350.3084	3510781121162	181,32
350	30	3,4/2,8	108	112.350.3010	3510781121216	193,55
350	32	3,4/2,8	84	110.350.3284	3510781121179	181,32
350	32	3,4/2,8	108	112.350.3210	3510781121223	215,83
380	32	3,8/3,2	110	112.380.3211	3510781121261	233,14
400	30	3,8/3,2	96	110.400.3096	3510781121285	225,08
400	30	3,8/3,2	120	112.400.3012	3510781121186	234,98
400	32	3,8/3,2	96	110.400.3296	3510781121353	225,08
420	30	4,0/3,2	96	110.420.3096	3510781121308	252,41
450	30	4,0/3,2	96	110.450.3096	3510781121315	278,27
450	30	4,0/3,2	108	112.450.3010	3510781121384	296,40
500	30	4,0/3,2	120	112.500.3012	3510781121339	332,38
500	32	4,0/3,2	120	112.500.3212	3661589034663	332,38
550	30	4,4/3,8	128	112.550.3012	3510781121377	455,14
600	30	4,6/4,0	140	112.600.3014	3510781121346	621,47



LSC.118AL

LAME DE DÉCOUPE DE MÉTAUX NON-FERREUX

- Pour la coupe de profilés aluminium minces, profilés plastiques, cadres et tôles alu.
- Avance automatique.
- Scie simple et double tête à mouvement ascendant.

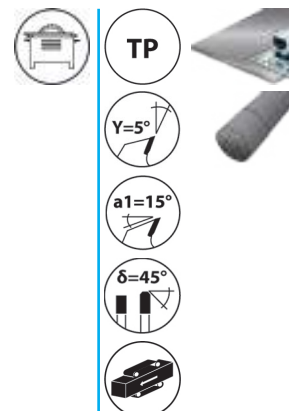

HM

EN847-1

ALUMINIUM, MÉTAUX NON FERREUX, PVC

Trous d'érgots combinés 2/10/60 + 2/11/63 + 2/12/64

				REF		€
250	30	3,2/2,5	80	118.250.3080	3661589034175	145,77
250	32	3,2/2,5	80	118.250.3280	3510781161045	163,88
300	30	3,2/2,5	72	116.300.3072	3510781161076	147,45
300	30	3,2/2,5	96	118.300.3096	3510781161090	164,38
300	32	3,2/2,5	96	118.300.3296	3510781161106	178,78
350	30	3,4/2,8	84	116.350.3084	3510781161113	180,72
350	30	3,4/2,8	108	118.350.3010	3510781161144	204,37
350	32	3,4/2,8	108	118.350.3210	3510781161151	204,37
400	30	3,8/3,2	96	116.400.3096	3510781161182	240,02
400	32	3,8/3,2	96	116.400.3296	3510781161403	243,96
420	30	3,8/3,2	96	116.420.3096	3510781161205	269,23
450	30	3,8/3,2	96	116.450.3096	3510781161212	278,27
450	30	4,0/3,2	110	118.450.3011	3510781161229	296,29
450	32	4,0/3,2	110	118.450.3211	3510781161410	296,29
500	30	4,0/3,2	120	118.500.3012	3510781161267	332,38
500	32	4,0/3,2	120	118.500.3212	3661589034656	332,38
550	30	4,4/3,8	128	118.550.3012	3510781161380	456,39
550	32	4,4/3,8	128	118.550.3212	3661589034687	456,39
600	30	4,6/4,0	140	118.600.3014	3510781161397	628,12



LSC.964AL

LAME DE DÉCOUPE DE MÉTAUX NON-FERREUX

- Lames jusqu'à 235 mm livrées avec bagues de réduction. Alésage 20 (20/16 + 20/12,7) et alésage 30 (30/16 + 30/20).

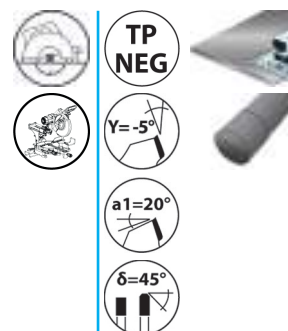

CLASSIC

ALUMINIUM, PVC

HM

EN847-1

Ø				REF		€
150	20	2,8/2,04	8	964.150.20AL	35107896422705	9,90
150	30	2,8/2,04	2	964.150.30AL	35107854169815	9,90
160	20	2,5/1,84	2	964.160.20AL	35107896412665	9,90
160	30	2,6/1,84	2	964.160.30AL	35107896423005	9,90
160	20	2,2/1,64	8	964.160.48AL	36615890431606	3,85
165	20	2,6/1,84	2	964.165.20AL	36615890791456	2,25
170	30	2,6/1,84	8	964.170.30AL	36615890791526	6,82
180	20	2,8/2,04	8	964.180.20AL	35107896414646	8,93
180	30	2,8/2,04	8	964.180.30AL	35107896423486	0,76
190	20	2,8/2,05	4	964.190.20AL	35107896415637	5,27
190	étoile	2,5/1,85	4	964.190.25AL	35107896426907	1,91
190	30	2,8/2,05	4	964.190.30AL	35107896425607	5,27
2003	02	,8/2,05	4	964.200.30AL	35107896416317	5,27
2103	02	,8/2,05	4	964.210.30AL	35107896417168	1,71
2163	02	,8/2,06	0	964.216.30AL	35107896417478	2,29
2163	02	,8/2,08	0	964.216.3080	35107896424169	6,91
2203	02	,8/2,06	2	964.220.30AL	35107896417858	7,99
2253	02	,5/1,86	8	964.225.30AL	36615890791831	14,31
2303	02	,8/2,06	2	964.230.30AL	35107896418398	9,28
2353	02	,8/2,06	2	964.235.30AL	35107896424618	9,28
2553	03	,2/2,38	0	964.255.30AL	35107896426691	24,73
2603	03	,2/2,38	0	964.260.30AL	35107896425841	24,73
2603	02	,5/1,88	0	964.260.25AL	35107896427371	24,73
3053	03	,2/2,58	0	964.305.80AL	35107896426141	28,83
3053	03	,2/2,59	6	964.305.96AL	35107896426211	50,64

MÉTAL

CLASSIC



FSC.00122



FRAISE-SCIE POUR LA COUPE D'ACIER

- Dureté 63/64 Hrc.
- Traitement vapeur.
- Fraises livrées avec trous d'entraînement standard.

MÉTAL, ACIER, MÉTAUX FERREUX

CHOIX DU PAS ET DE LA DENTURE		
PAS DE 3 MM	Pour tubes et profils à parois minces de 1 à 2 mm d'épaisseur.	
PAS DE 4 MM	Pour barres fines, tubes et profils de 2 à 4 mm d'épaisseur.	
DENTURE ACMÉE (PAS DE 3/4/5 MM)	Les dents sont d'une hauteur unique et sont chanfreinées alternativement à gauche et à droite.	
DENTURE HELLER (PAS DE 6/8/10 MM)	Une dent sur deux est chanfreinée des deux côtés (dent ébauchée) et se trouve plus haute que la dent suivante (dent finisseuse) qui est droite.	
PAS DE 5 MM	Pour profils d'épaisseur moyenne, tubes et matériaux de 4 à 15 mm d'épaisseur.	
PAS DE 6 MM	Pour profils épais, tubes et matériaux de 15 à 30 mm d'épaisseur.	
PAS DE 8 MM	Pour matériaux épais, jusqu'à 60 mm d'épaisseur.	
PAS DE 10 MM ET +	Pour matériaux très épais, profils pleins de 60 mm et plus.	

TROUS D'ENTRAÎNEMENT STANDARD		
ALÉSAGE	CODE ALÉSAGE	DIMENSIONS
32	MX	2/8/45 + 2/11/63
40	RG	2/8/55 + 4/12/64









REF



€

200	32	2,0	160	4	122.204.2032	3510781221008	70,28
225	32	2,0	180	4	122.224.2032	3510781221022	72,96
225	32	2,0	120	6	122.226.2032	3510781221039	72,96
250	32	2,0	200	4	122.254.2032	3510781221060	78,26
250	32	2,0	160	5	122.255.2032	3510781221077	78,26
250	32	2,0	128	6	122.256.2032	3510781221084	78,26
250	32	2,5	250	3	122.253.2532	3510781221183	84,88
250	32	2,5	200	4	122.254.2532	3510781221190	84,88
250	32	2,5	160	5	122.255.2532	3510781221206	96,21
250	32	2,5	128	6	122.256.2532	3510781221213	96,21
250	40	2,5	200	4	122.254.2540	3510781221237	84,88
250	40	2,5	160	5	122.255.2540	3510781221244	96,21
250	40	2,5	128	6	122.256.2540	3510781221251	96,21
275	32	2,5	220	4	122.274.2532	3510781221282	107,36
275	32	2,5	180	5	122.275.2532	3510781221299	107,36
275	32	2,5	140	6	122.276.2532	3510781221305	107,36

MÉTAL

					REF		€
275	40	2,5	280	3	122.273.2540	3510781221329	107,36
275	40	2,5	220	4	122.274.2540	3510781221336	107,36
275	40	2,5	180	5	122.275.2540	3510781221343	107,36
275	40	2,5	140	6	122.276.2540	3510781221350	107,36
275	40	2,5	110	8	122.278.2540	3510781221367	107,36
275	40	2,5	90	10	122.271.2540	3510781221374	107,36
300	32	2,5	300	3	122.303.2532	3510781221381	133,92
300	32	2,5	220	4	122.304.2532	3510781221398	133,92
300	32	2,5	180	5	122.305.2532	3510781221404	133,92
300	32	2,5	160	6	122.306.2532	3510781221411	133,92
300	32	2,5	120	8	122.308.2532	3510781221428	133,92
300	40	2,5	300	3	122.303.2540	3510781221435	133,92
300	40	2,5	220	4	122.304.2540	3510781221442	133,92
300	40	2,5	180	5	122.305.2540	3510781221459	133,92
300	40	2,5	160	6	122.306.2540	3510781221466	133,92
300	40	2,5	120	8	122.308.2540	3510781221473	133,92
315	32	2,5	240	4	122.314.2532	3510781221497	147,18
315	32	2,5	200	5	122.315.2532	3510781221503	147,18
315	32	2,5	160	6	122.316.2532	3510781221510	147,18
315	32	2,5	120	8	122.318.2532	3510781221527	147,18
315	40	2,5	240	4	122.314.2540	3510781221534	147,18
315	40	2,5	200	5	122.315.2540	3510781221541	147,18
315	40	2,5	160	6	122.316.2540	3510785416998	147,18
315	32	3,0	240	4	122.314.3032	3510781221572	147,18
315	32	3,0	200	5	122.315.3032	3510781221589	147,18
315	32	3,0	160	6	122.316.3032	3510781221596	147,18
315	40	3,0	200	5	122.315.3040	3510781221626	147,18
315	40	3,0	160	6	122.316.3040	3510781221633	147,18
315	40	3,0	120	8	122.318.3040	3510781221640	147,18
350	32	3,0	220	5	122.355.3032	3510781221657	220,10
350	32	3,0	180	6	122.356.3032	3510781221664	220,10
350	32	3,0	140	8	122.358.3032	3510781221671	220,10
350	40	3,0	180	6	122.356.3040	3510781221688	220,10
370	40	3,0	190	6	122.376.3040	3510781221701	269,13
370	40	3,0	140	8	122.378.3040	3510781221718	269,13

Respecter la vitesse maximale de 600 tr/min

LAMES DE SCIE CIRCULAIRE

MÉTAL

CLASSIC



HSS
CO5

FSC.122CO

FRAISE-SCIE POUR LA COUPE D'ACIER INOXYDABLE



- Dureté 63/64 Hrc.
- Traitement vapeur.
- Fraises livrées avec trous d'entraînement standard.

ACIER INOXYDABLE		
CHOIX DU PAS ET DE LA DENTURE		
PAS DE 3 MM	Pour tubes et profilés à parois minces de 1 à 2 mm d'épaisseur.	
PAS DE 4 MM	Pour bords droits, tubes et profilés de 2 à 4 mm d'épaisseur.	
DENTURE ACNÉE (PAS DE 3/4/5 MM)	Les dents sont d'une hauteur unique et sont chanfreinées alternativement à gauche et à droite.	
DENTURE HELLER (PAS DE 6/8/10 MM)	Une dent sur deux est chanfreinée des deux côtés (dent ébauchée) et se trouve plus haute que la dent suivante (dent finisseuse) qui est droite.	
PAS DE 5 MM	Pour profilés d'épaisseur moyenne, tubes et matériaux de 4 à 15 mm d'épaisseur.	
PAS DE 6 MM	Pour profilés épais, tubes et matériaux de 15 à 30 mm d'épaisseur.	
PAS DE 8 MM	Pour matériaux épais, jusqu'à 60 mm d'épaisseur.	
PAS DE 10 MM ET +	Pour matériaux très épais, profilés pleins de 60 mm et plus.	

TROUS D'ENTRAÎNEMENT STANDARD		
ALÉSAGE	CODE ALÉSAGE	DIMENSIONS
32	MX	2/8/45 + 2/11/63
40	RG	2/8/55 + 4/12/64



REF



€

250	32	2,5	200	4	122CO5.254.2532	3661589074843	125,07
250	32	2,5	160	5	122CO5.255.2532	3661589074850	125,07
275	32	2,5	220	4	122CO5.274.2532	3661589074867	139,56
275	32	2,5	180	5	122CO5.275.2532	3661589074874	139,56
275	32	2,5	140	6	122CO5.276.2532	3661589074881	139,56
275	40	2,5	220	4	122CO5.274.2540	3661589074898	139,56
275	40	2,5	180	5	122CO5.275.2540	3661589074904	139,56
275	40	2,5	140	6	122CO5.276.2540	3661589074911	139,56
300	32	2,5	220	4	122CO5.304.2532	3661589074928	197,30
300	32	2,5	180	5	122CO5.305.2532	3661589074935	197,30
300	32	2,5	140	6	122CO5.306.2532	3661589074942	197,30
315	32	2,5	240	4	122CO5.314.2532	3661589074959	216,85
315	32	2,5	200	5	122CO5.315.2532	3661589074966	216,85
315	32	2,5	160	6	122CO5.316.2532	3661589074973	216,85

Respecter la vitesse maximale de 600 tr/min

CLASSIC

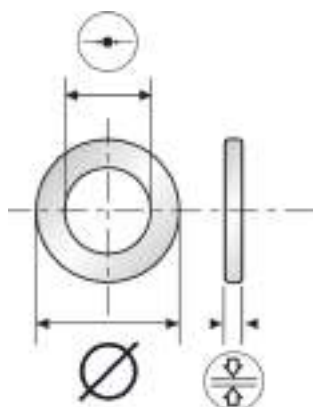

LSC.09650

BAGUE DE RÉDUCTION D'ALÉSAGE CRANTÉE

- Lors de l'utilisation, veillez à ce que les bagues soient suffisamment larges et ne se déplacent pas.
- Pour des raisons de sécurité, n'utiliser des bagues que dans la limite des possibilités de serrage de la lame par les flasques.
- La bague ne doit en aucun cas être plus épaisse que le corps de la lame: veuillez vous reporter aux dimensions indiquées dans les lames.

Ø	Ø	Ø t	REF		€
20	10	1,4	9650.2010.14	3510785415465	3,79
20	13	1,4	9650.2013.14	3510789650039	3,79
20	15	1,4	9650.2015.14	3510789650046	3,79
20	16	1,4	9650.2016.14	3510789650053	3,79
25	20	1,8	9650.2520.18	3510789650077	3,79
30	15	1,8	9650.3015.18	3510789650091	3,79
30	16	1,8	9650.3016.18	3510789650107	3,79
30	18	1,8	9650.3018.18	3510789650114	3,79
30	20	1,8	9650.3020.18	3510789650138	3,79
30	22	1,8	9650.3022.18	3510789650145	3,79
30	25	1,8	9650.3025.18	3510789650152	3,79
30	25,4	1,8	9650.3026.18	3510789650169	3,79
32	30	1,8	9650.3230.18	3510789650183	5,04
35	30	1,8	9650.3530.18	3510789650206	5,04
40	30	2,0	9650.4030.20	3510789650213	5,04
40	32	2,0	9650.4032.20	3510789650220	5,04
50	30	2,5	9650.5030.25	3510789650237	5,04

LSC.PREST

PRESTATION

Désignation	REF		€
REALSAGE A \$\$ MM ≤ À 35MM	26090	3510785435937	37,20
REALSAGE A \$\$ MM ≤ À 50MM	26091	3510785435944	46,40
REALSAGE A \$\$ MM > À 50MM	26092	3661589104083	61,80
PERCAGE 1 TROU D'ERGOT (1/\$\$/\$\$)	26100	3510785435951	14,80

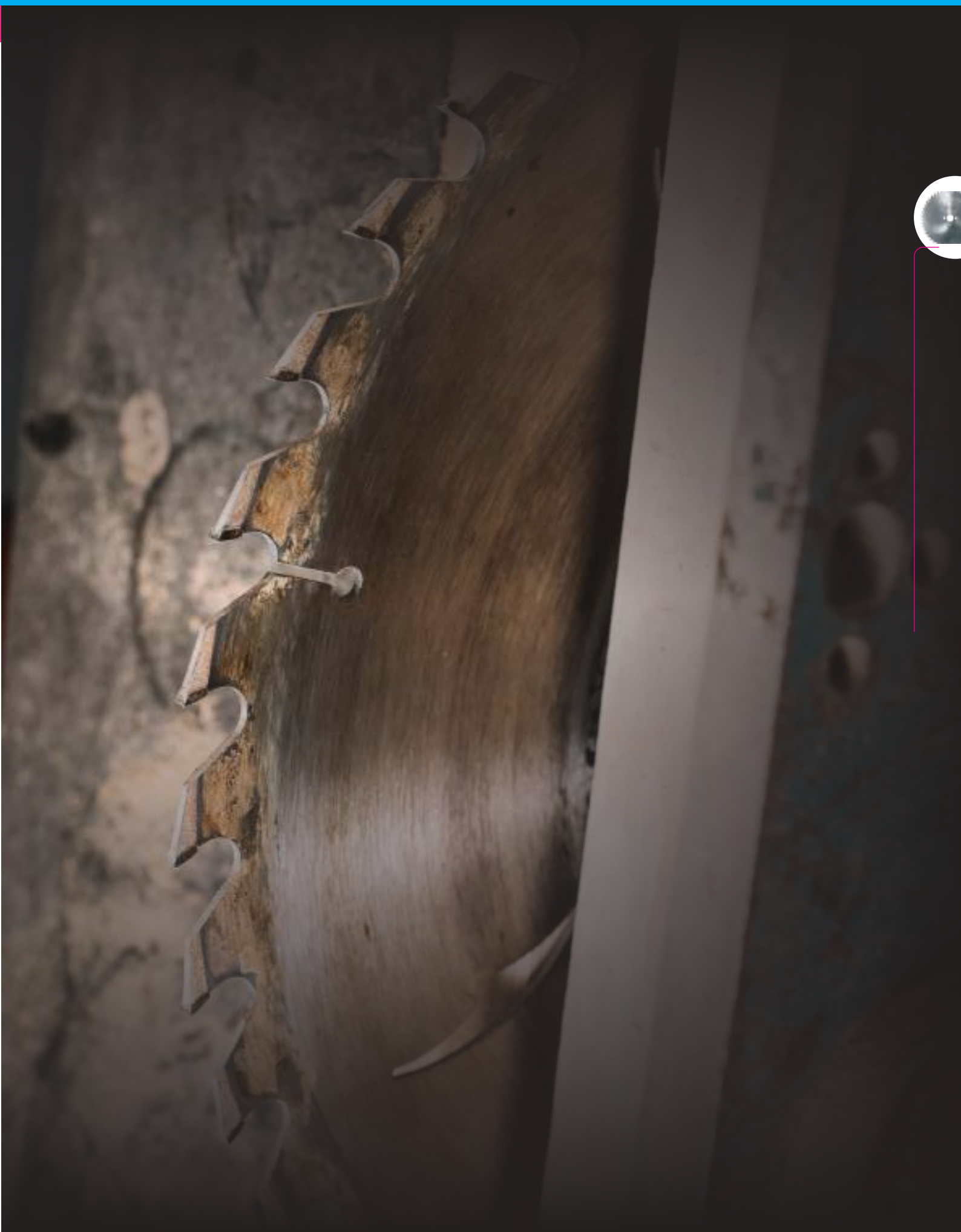



info@leman-sa.com

GUIDE DE CHOIX P. 112

INFOS TECHNIQUES P. 116

SCIE SAUTEUSE

 **BOIS MASSIF** P. 118

 **PANNEAUX & DÉRIVÉS DU BOIS** P. 119

 **MÉTAL** P. 124

 **MULTI-MATÉRIAUX** P. 127

 **MAÇONNERIE** P. 131

SCIE SABRE

 **BOIS MASSIF** P. 129

 **MÉTAL** P. 132

 **MULTI-MATÉRIAUX** P. 134

LAMES DE SCIE À CHANTOURNER P. 137

CLASSIC  pour les travaux courants et polyvalents.



GUIDE DE CHOIX

- Utilisation optimale
- Utilisation adaptée
- Utilisation possible

Gamme	Page	Matière	Denture	Bois Massif	Contre plaqué	Bois latté	Aggloméré	Mélaminé	MDF	
LSS.07008	119	CV	FA	•		•	
LSS.07009	119	CV	FA	•		•	
LSS.07011	121	CV	FA	•		•	
LSS.07010	118	CV	AA	...	•	..	•		•	
LSS.07012	118	CV	AA	...	•	..	•		•	
LSS.07007	118	CV	FA	...	•	..			•	
LSS.07006	119	CV	FA		•		•	
LSS.07017	123	CV	AD	
LSS.07016	123	CV	AD	
LSS.07024	127	BiM	AD	
LSS.07003	120	CV	AD	
LSS.07021	122	CV	AD	
LSS.07004	120	CV	AD	•		..	
LSS.07005	121	CV	AD	•		..	
LSS.07002	120	CV	AD	•		..	
LSS.07014	122	CV	AD		•	..	
LSS.07023	122	CV	AD		•	..	
LSS.07013	121	CV	AD			
LSS.07107	126	BiM	FA							
LSS.07110	126	BiM	FA							
LSS.07105	125	HSS	FA							
LSS.07102	124	HSS	FA							
LSS.07106	125	BiM	FO							
LSS.07101	124	HSS	FA							
LSS.07103	124	HSS	FA							
LSS.07104	125	HSS	FA							
LSS.07120	126	BiM	FO							
LSS.07001	127	BiM	FA	..						
LSS.07055	127	PCD								

LAMES DE SCIE SAUTEUSE

 BOIS MASSIF

 MULTI-MATÉRIAUX

 MÉTAL

 CARRELAGE

 PANNEAUX & DÉRIVÉS DU BOIS

	HPL	Parquet	Bois clouté	Matières plastiques	Alu	Inox	Acier	Cuivre	Sandwich	Corian	Fibro-ciment	Carrelage
				.								
		
		
		
		...										
		..										
						
						
							
									
							...					
							...					
										
						
										



GUIDE DE CHOIX

- Utilisation optimale
- Utilisation adaptée
- Utilisation possible

Gamme	Page	Matière	Denture	Bois de chauffage	Bois massif	Contre plaqué	Bois latté	Aggloméré	MDF	Bois clouté	
LSS.07703	129	CV	FA	•••	•••						
LSS.07704	130	CV	AA	•••	••						
LSS.07701	129	CV	FA		••				••		
LSS.07702	129	CV	FA		•••						
LSS.07706	130	CV	AD		••	•••	•••		••		
LSS.07716	130	CV	FA		••	••	••	*	••		
LSS.07708	132	BiM	FA								
LSS.07709	132	BiM	FO								
LSS.07710	133	BiM	FO								
LSS.07720	133	BiM	FO								
LSS.07721	135	BiM	FO		••			•	••	•••	
LSS.07705	134	BiM	FA							•••	
LSS.07711	135	BiM	FO							•••	
LSS.07713VARIO	134	BiM	FO							••	
LSS.07714VARIO	134	BiM	FO							••	
LSS.07715	135	BiM	FO							••	
LSS.00771	131	HM	-								

LAMES DE SCIE SABRE



BOIS MASSIF



MULTI-MATÉRIAUX



MÉTAL



MAÇONNERIE



PANNEAUX & DÉRIVÉS DU BOIS

Palette	Matières plastiques	Alu	Inox	Acier	Plâtre	Fibro-ciment	Béton cellulaire	Brique creuse	Carrelage	Isolant fibres
	..									
	..									
							
							
							
							
				..						
..				..						
..				..						
...		.		..						
...		.		..						
				...						
							





MATIÈRE OUTIL

Les domaines d'application étant très variés, il est nécessaire d'avoir différents types de lame. Utiliser la lame adaptée augmente la performance et prolonge la durée de vie de l'outil. Pour cela, le choix doit être fait par type de matière de coupe, par type de denture, par longueur utile & par pas.

CV

ACIER CHROME-VANADIUM

L'acier allié au Chrome-Vanadium est utilisé pour travailler les matériaux tendres comme le bois et les dérivés du bois.

BI-MÉTAL

BI-MÉTAL

L'acier Bi-Métal est une combinaison de deux aciers aux caractéristiques spécifiques. L'acier à ressort apporte l'élasticité nécessaire pour que la lame conserve sa forme initiale après l'effort de coupe, et l'HSS au Cobalt apporte la longévité de coupe. Il est indiqué pour la coupe de bois, bois avec métal ou de l'acier.

HSS

ACIER HSS

L'acier rapide est traité au four à vide, de même que le BiM. On le retrouve sur les lames pour les aciers et les métaux non ferreux.

HM

CARBURE DE TUNGSTÈNE

Le carbure de tungstène est très résistant à l'abrasion, pour différents usages. On le trouve sous forme de dents brasées ou sous forme de concrétion.

DIAMANT

DIAMANT

Le diamant est le matériau aux performances supérieures au carbure vis-à-vis de l'abrasion. On va le trouver sous forme de concrétion.

ÉCARTEMENT DES DENTS

L'écart entre les dents, appelé le pas, est la cote de pointe à pointe. Cet écart peut être exprimé en millimètres ou en nombre de dents par pouce. Plus le pas est petit, plus l'épaisseur du matériau doit être basse.

AFFÛTAGE

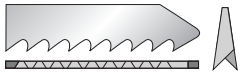

AD

AFFÛTÉE DÉPOUILLÉE

L'arête de chaque dent est perpendiculaire à l'axe de coupe. Ainsi chaque dent parfaitement alignée travaille sur toute sa largeur, garantissant une coupe rapide, tranchante et rectiligne. Les flancs dépouillés de la lame et le dos aminci n'entrent pas en contact avec le bois pendant le sciage et permettent une découpe très fine et très propre.



AA

AFFÛTÉE AVOYÉE

Les fibres de bois sont coupées selon l'angle oblique d'affûtage des dents. Cette denture garantit une vitesse de coupe élevée. Elle est particulièrement adaptée pour la découpe du bois.

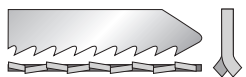

FA

FRAISÉE AVOYÉE

Les fibres de bois sont déchirées plutôt que coupées. L'avoyage laisse des traces lors du mouvement de la lame de haut en bas, d'où une coupe rugueuse dans le bois. Par contre, ce type d'avoyage est fréquent pour le métal.

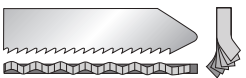

FO

FRAISÉE ONDULÉE

Particulièrement adapté pour la découpe des pièces minces type tôle acier ou contreplaqué. L'avoyage fraisé ondulé permet de toujours maintenir une surface de contact entre la lame et le matériau, évitant les à-coups et assurant ainsi une coupe rectiligne.



HM

Les lames à plaquettes carbure rapportées sont à la fois extrêmement dures et rapides grâce à leurs pastilles carbure. Elles sont donc adaptées à la découpe des matières abrasives et elles affichent des performances de coupe et une endurance exceptionnelles dans le bois.

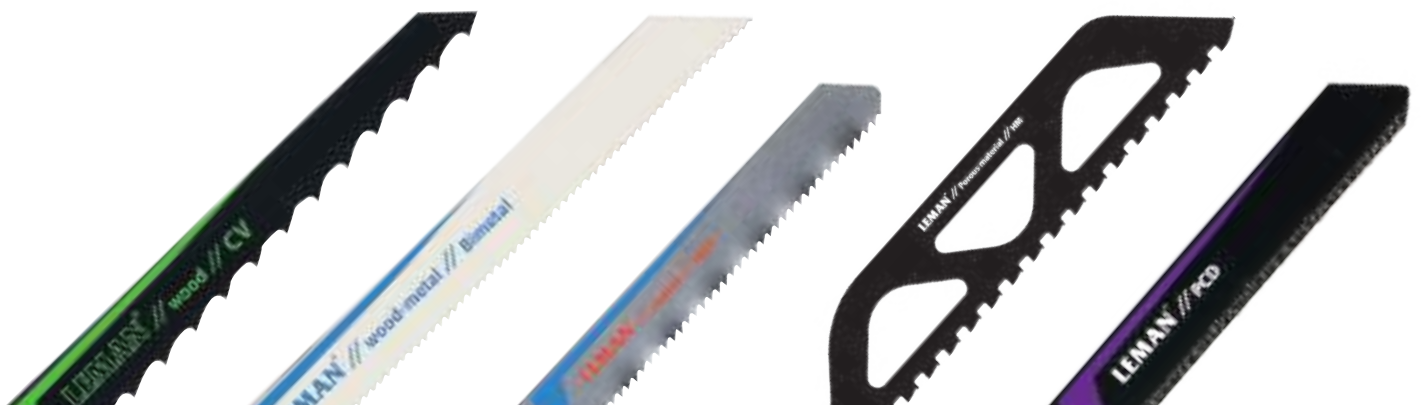

BOIS MASSIF

CLASSIC



LSS.07007

LAME DE SCIE SAUTEUSE

CHEVRON ET BOIS ÉPAIS

- Coupe rapide.

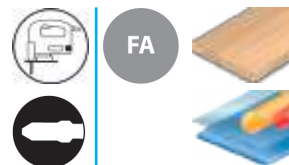

CV

BOIS, MATIÈRES PLASTIQUES

LU		REF		€
110	3	7007.03	3510787007033	4,07
110	5	7007.05	3510787007057	5,47

CLASSIC

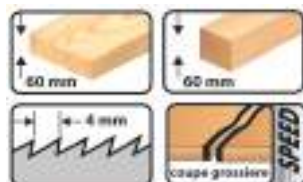

LSS.07010

LAME DE SCIE SAUTEUSE

COUPE RAPIDE

- Bois tendre et panneaux de particules.

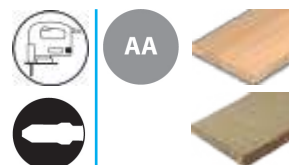

CV

BOIS, AGGLOMÉRÉ

LU		REF		€
75	3	7010.03	3510780116633	4,18
75	5	7010.05	3510787010057	6,08

CLASSIC

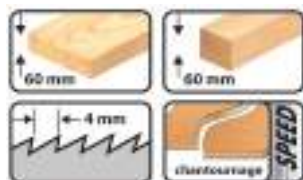

LSS.07012

LAME DE SCIE SAUTEUSE

COUPE COURBE RAPIDE

- Bois tendre et panneaux de particules.

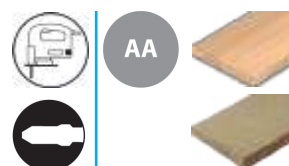

CV

BOIS, AGGLOMÉRÉ

LU		REF		€
75	3	7012.03	3510787012037	4,18
75	5	7012.05	3510787012051	6,08

LAMES DE SCIE SAUTEUSE ET SCIE SABRE

PANNEAUX ET DÉRIVÉS DU BOIS

CLASSIC

LSS.07006

LAME DE SCIE SAUTEUSE



COUPE RAPIDE ET GROSSIÈRE

- Bois tendre et panneaux de particules.

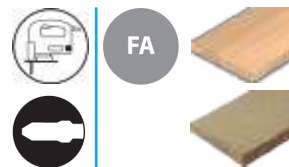

CV

BOIS, AGGLOMÉRÉ

LU		REF		€
75	3	7006.03	3510787006036	4,07
75	5	7006.05	3510787006050	5,36

CLASSIC

LSS.07008

LAME DE SCIE SAUTEUSE

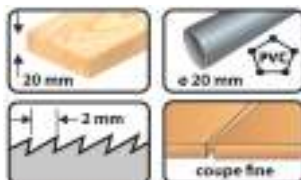

COUPE FINE

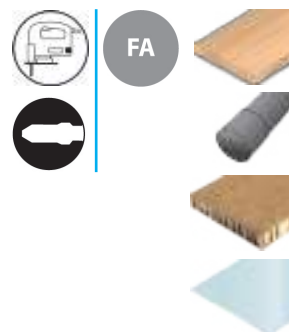

CV

BOIS, PVC, CARTON, PLEXIGLASS

LU		REF		€
50	3	7008.03	3510787008030	3,12

CLASSIC

LSS.07009

LAME DE SCIE SAUTEUSE

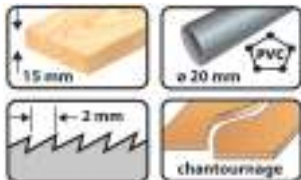

COUPE COURBE

- Bois tendre et contre-plaqué.

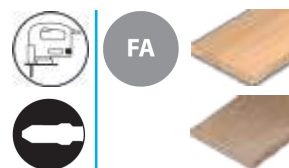

CV

BOIS, CONTREPLAQUÉ

LU		REF		€
50	3	7009.03	3510787009037	3,97

PANNEAUX ET DÉRIVÉS DU BOIS

CLASSIC

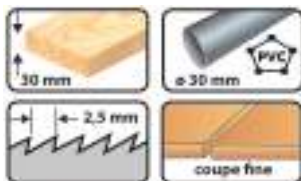

LSS.07002

LAME DE SCIE SAUTEUSE

COUPE FINE ET PRÉCISE

- Bois dur et tendre, contreplaqué et plastiques.



AD



CV

BOIS, CONTREPLAQUÉ, MATIÈRES PLASTIQUES

LU		REF		€
75	3	7002.03	3510787002038	4,63
75	5	7002.05	3510787002052	6,97

CLASSIC

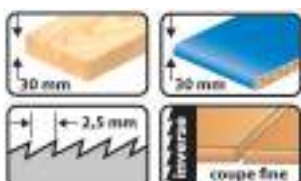

LSS.07003

LAME DE SCIE SAUTEUSE

COUPE PROPRE DE PLANS DE TRAVAIL

- Coupe propre en surface grâce à sa denture inversée.



AD



CV

CONTREPLAQUÉ, MÉLAMINÉ

LU		REF		€
75	3	7003.03	3510787003035	5,42
75	5	7003.05	3510787003059	7,26

CLASSIC

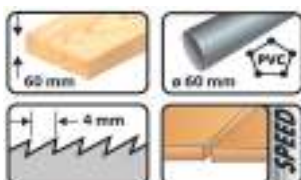

LSS.07004

LAME DE SCIE SAUTEUSE

COUPE FINE ET RAPIDE

- Bois dur et tendre, contreplaqué et plastiques.



AD



CV

BOIS, CONTREPLAQUÉ, MATIÈRES PLASTIQUES

LU		REF		€
75	3	7004.03	3510787004032	4,74
75	5	7004.05	3510787004056	6,97

LAMES DE SCIE SAUTEUSE ET SCIE SABRE

PANNEAUX ET DÉRIVÉS DU BOIS

CLASSIC

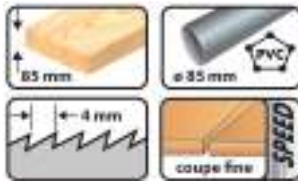

LSS.07005

LAME DE SCIE SAUTEUSE

COUPE FINE ET RAPIDE PANNEAUX ÉPAIS

- Bois dur et tendre, contreplaqué et plastiques.



AD



CV

BOIS, CONTREPLAQUÉ, MATIÈRES PLASTIQUES

LU		REF		€
110	3	7005.03	3510787005039	7,92
110	5	7005.05	3510787005053	9,05

CLASSIC



LSS.07011

LAME DE SCIE SAUTEUSE

COUPE FINE ET PRÉCISE

- Bois dur et tendre, contreplaqué et plastiques.



AD



CV

BOIS, CONTREPLAQUÉ, MATIÈRES PLASTIQUES

LU		REF		€
110	3	7011.03	3510787011030	5,13
110	5	7011.05	3510787011054	7,98

CLASSIC

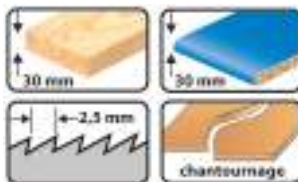

LSS.07013

LAME DE SCIE SAUTEUSE

COUPE COURBE ET FINE

- Denture sur le dos, chantournage facilité des panneaux replaqués et des parquets.



AD



CV

PARQUET, MATIÈRES PLASTIQUES, CONTREPLAQUÉ

LU		REF		€
75	5	7013.05	3510787013058	9,59

PANNEAUX ET DÉRIVÉS DU BOIS



CLASSIC

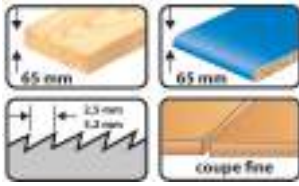

LSS.07014

LAME DE SCIE SAUTEUSE

COUPE FINE DE PLANS DE TRAVAIL

- Bois durs, panneaux de particules replaqués d'épaisseurs variables, plans de travail.

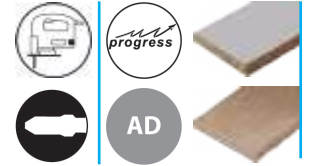

CV

MÉLAMINÉ, CONTREPLAQUÉ

LU		REF		€
90	5	7014.05	3510787014055	14,12

CLASSIC

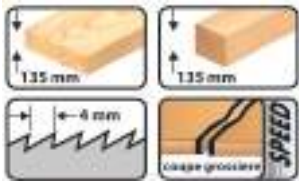

LSS.07023

LAME DE SCIE SAUTEUSE

BOIS ET PANNEAUX ÉPAIS

- Bois tendres et panneaux, bois de construction épais, matériaux sandwich et bois de charpente.

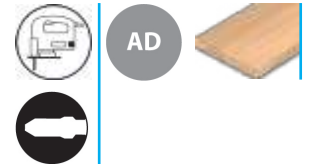

CV

BOIS

LU		REF		€
155	5	7023.05	3510785435258	19,90

CLASSIC

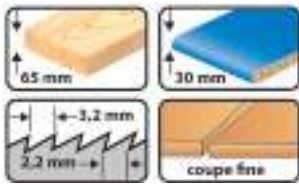

LSS.07021

LAME DE SCIE SAUTEUSE

COUPE FINE DE BOIS DUR

- Panneaux de particules replaqués d'épaisseurs variables et plans de travail.

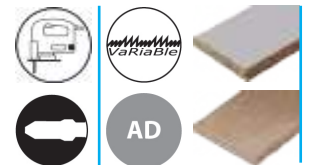

CV

MÉLAMINÉ, CONTREPLAQUÉ

LU		REF		€
95	5	7021.05	3510785413041	11,87

LAMES DE SCIE SAUTEUSE ET SCIE SABRE

PANNEAUX ET DÉRIVÉS DU BOIS



CLASSIC

LSS.07017

LAME DE SCIE SAUTEUSE

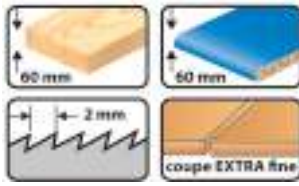

COUPE DESSUS DESSOUS EXTRA FINE

- Coupe propre et sans éclat.
- Coupe grossière dans le corian®.

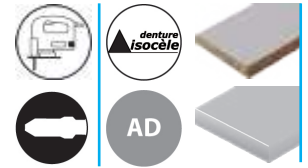

CV

MÉLAMINÉ, CORIAN

LU		REF		€
75	5	7017.05	3510787017056	8,81



CLASSIC

LSS.07016

LAME DE SCIE SAUTEUSE

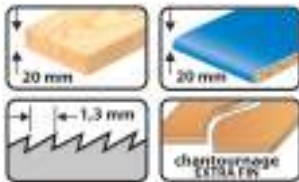

COUPE COURBE DESSUS DESSOUS

- Coupe dessus dessous précise et sans éclat.
- Lame étroite pour chantournage
- Coupe grossière dans le corian®.

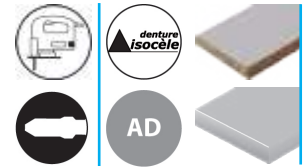

CV

MÉLAMINÉ, CORIAN

LU		REF		€
50	5	7016.05	3510787016059	9,59

CLASSIC

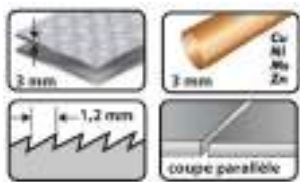

LSS.07101
LAME DE SCIE SAUTEUSE

COUPE DE MÉTAL FIN

- Coupe parallèle.

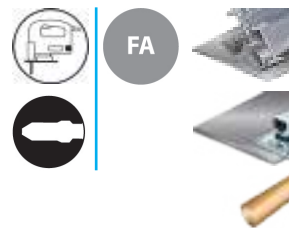

HSS

MÉTAUX NON FERREUX, ALUMINIUM

LU		REF		€
50	3	7101.03	3510787101038	5,74
50	5	7101.05	3510787101052	8,20

CLASSIC



LSS.07102
LAME DE SCIE SAUTEUSE

TUYAUX ET PROFILÉS

- Tuyaux et profilés en aluminium, cuivre...

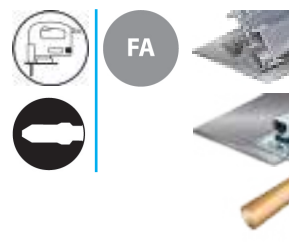

HSS

MÉTAUX NON FERREUX, ALUMINIUM, CUIVRE

LU		REF		€
110	3	7102.03	3510780116664	7,53
110	5	7102.05	3510787102059	9,87

CLASSIC

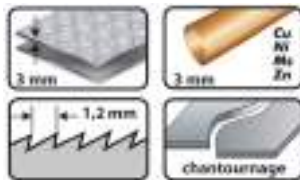

LSS.07103
LAME DE SCIE SAUTEUSE

COUPE COURBE DE MÉTAL FIN

- Matériaux fins, métalliques non-ferreux et aluminium.

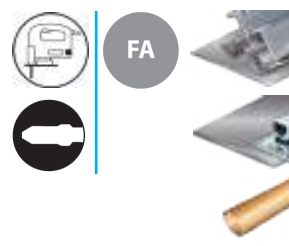

HSS

MÉTAUX NON FERREUX, ALUMINIUM, CUIVRE

LU		REF		€
50	5	7103.05	3510787103056	8,59

LAMES DE SCIE SAUTEUSE ET SCIE SABRE

MÉTAL

CLASSIC

LSS.07104

LAME DE SCIE SAUTEUSE



COUPE DE MÉTAL ÉPAIS

- Métaux non-ferreux et aluminium.
- Coupe parallèle.



FA



HSS

MÉTAUX NON FERREUX, ALUMINIUM

LU		REF		€
50	3	7104.03	3510787104039	6,13
50	5	7104.05	3510787104053	8,59

CLASSIC

LSS.07105

LAME DE SCIE SAUTEUSE

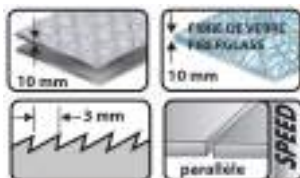

COUPE PARALLÈLE RAPIDE

- Aluminium, métaux non-ferreux, métaux, fibre de verre.



FA



HSS

MÉTAUX NON FERREUX, ALUMINIUM, FIBRE DE VERRE

LU		REF		€
75	3	7105.03	3510787105036	6,13
75	5	7105.05	3510787105050	8,48

CLASSIC

LSS.07106

LAME DE SCIE SAUTEUSE

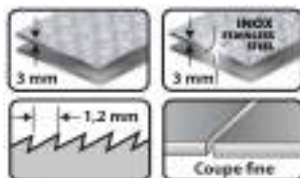

COUPE FINE DE TÔLE MINCE

- Tôles minces en acier, inox ou aluminium.



FO



BI-MÉTAL

ACIER, ACIER INOXYDABLE, ALUMINIUM

LU		REF		€
50	3	7106.03	3510787106033	7,53
50	5	7106.05	3510787106057	10,55

MÉTAL

CLASSIC

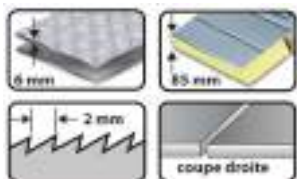

LSS.07107

LAME DE SCIE SAUTEUSE

COUPE DROITE BI-MÉTAL

- Coupe parallèle.
- Panneaux sandwich, profilés acier ou inox et plexiglas.



FA



BI-MÉTAL

ACIER, ACIER INOXYDABLE, MATÉRIAUX MULTI-COUCHES OU SANDWICH, PLEXIGLASS

LU		REF		€
110	5	7107.05	3510787107054	13,98

CLASSIC

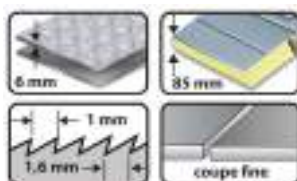

LSS.07110

LAME DE SCIE SAUTEUSE

COUPE FINE SPÉCIALE MÉTAL

- Tôles minces en acier ou inox et panneaux sandwich.



FA



BI-MÉTAL

ACIER, ACIER INOXYDABLE, MATÉRIAUX MULTI-COUCHES OU SANDWICH

LU		REF		€
110	5	7110.05	3510785413034	15,22

CLASSIC

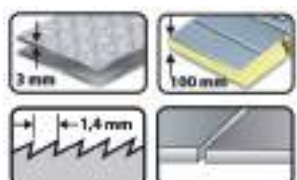

LSS.07120

LAME DE SCIE SAUTEUSE

COUPE FINE SANS À-COUP

- Tôles minces en acier ou inox et panneaux sandwich.



FO



BI-MÉTAL

ACIER, ACIER INOXYDABLE, MATÉRIAUX MULTI-COUCHES OU SANDWICH

LU		REF		€
180	5	7120.05	3661589085061	23,14

LAMES DE SCIE SAUTEUSE ET SCIE SABRE

MULTI-MATÉRIAUX

CLASSIC

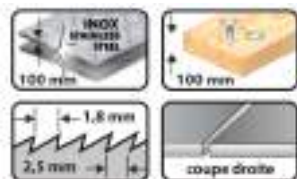

LSS.07001

LAME DE SCIE SAUTEUSE

«COUPE TOUT»

- Bois durs et tendres avec clous et profilés aluminium.

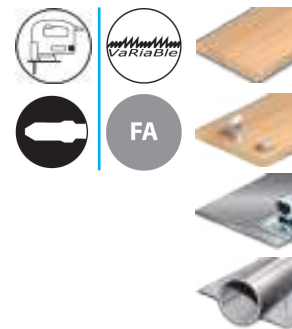

BI-MÉTAL

BOIS, BOIS CLOUTÉ, ALUMINIUM, ACIER INOXYDABLE

LU		REF		€
110	3	7001.03	3510787001031	10,42
110	5	7001.05	3510787001055	14,39

CLASSIC

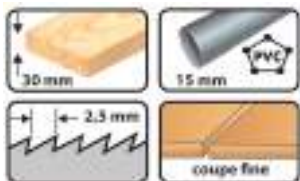

LSS.07024

LAME DE SCIE SAUTEUSE

MATÉRIAUX TRES DURS

- Bois durs et matériaux composites, plastique renforcé de fibre de verre ou époxy.

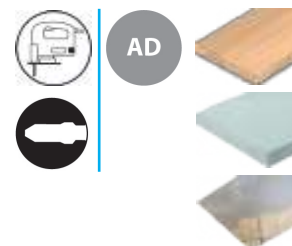

BI-MÉTAL

BOIS, MATÉRIAUX COMPOSITES, FIBRE DE VERRE, REVÊTEMENT ÉPOXY

LU		REF		€
75	5	7024.05	3510785435265	13,38

CLASSIC

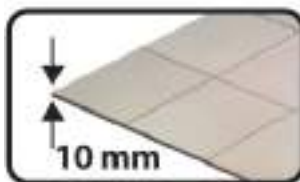
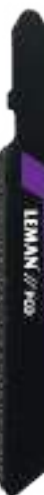

LSS.07055

LAME DE SCIE SAUTEUSE

CARRELAGE ET MATÉRIAUX

- Concrétion diamant.
- Matériaux durs et minéraux.
- Coupe droite.

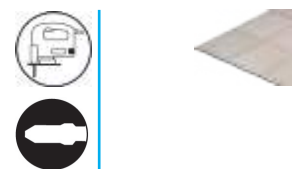

PCD

CARRELAGE

LU		REF		€
10	1	7055.01	3661589085054	14,76

MULTI-MATÉRIAUX





LSS.08051

ASSORTIMENT DE 10 / 20 LAMES DE SCIE SAUTEUSE

- LSS.07002 x3 / x5
- LSS.07004 x2 / x5
- LSS.07003 x2 / x5
- LSS.07101 x3 / x5



	REF		€
10	8051.10	3661589074690	14,93
20	8051.20	3661589074683	22,62





LSS.08551

ASSORTIMENT DE 10 LAMES DE SCIE SAUTEUSE

- LSS.07402 x3
- LSS.07403 x2
- LSS.07408 x2
- LSS.07502 x3



	REF		€
10	8551.10	3661589074706	14,93

LAMES DE SCIE SAUTEUSE ET SCIE SABRE

BOIS MASSIF

CLASSIC

LSS.07701

LAME DE SCIE SABRE

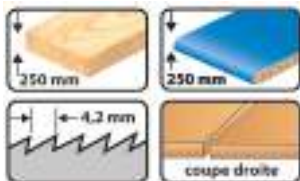

COUPE DROITE



FA



CV

BOIS, AGGLOMÉRÉ, MATIÈRES PLASTIQUES

LU		REF		€
280	5	7701.05	3510787701054	24,64

CLASSIC

LSS.07702

LAME DE SCIE SABRE

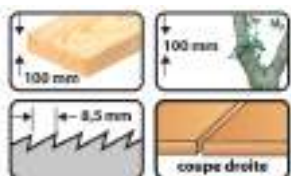

COUPE GROSSIÈRE

- Coupe rapide en courbe.
- Bois tendres et verts.



FA



CV

BOIS

LU		REF		€
130	5	7702.05	3510787702051	12,71

CLASSIC

LSS.07703

LAME DE SCIE SABRE

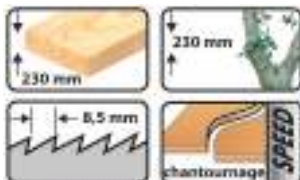

COUPE DROITE ET COURBE

- Coupe rapide des bois verts.
- Elagage de branches.



FA



CV

BOIS

LU		REF		€
280	2	7703.02	3510787703027	10,65
280	5	7703.05	3510787703058	24,64

BOIS MASSIF

CLASSIC

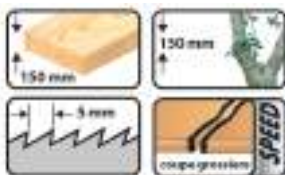

LAME DE SCIE SABRE

BOIS DE CHAUFFAGE LSS.07704

- Coupe rapide et droite.
- Denture trempée.
- Bois verts, bois de chauffage et élagage de branches.



FA



CV

BOIS, BOIS DE CHAUFFAGE

		REF		€
210	2	7704.02	3510787704024	10,21
210	5	7704.05	3510787704055	17,90

CLASSIC

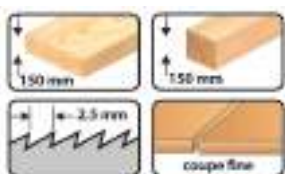

LSS.07706

LAME DE SCIE SABRE

SPÉCIALE MENUISIER

- Denture meulée 3 fois.
- Coupe très propre dans les bois durs et tendres.



AD



CV

BOIS

		REF		€
210	5	7706.05	3510787706059	62,86

CLASSIC

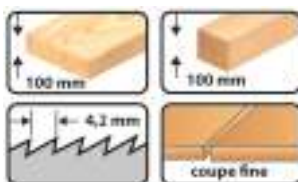

LSS.07716

LAME DE SCIE SABRE COUPE PLONGEANTE

POLYVALENTE

- Vitesse de coupe élevée.



AA



CV

BOIS, CONTREPLAQUÉ, AGGLOMÉRÉ, MATIÈRES PLASTIQUES

		REF		€
130	5	7716.05	3510785435227	12,32

MAÇONNERIE



CLASSIC

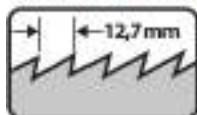
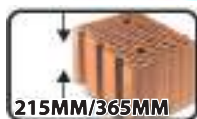

HM

LSS.00771

LAME DE SCIE SABRE POUR MAÇONNERIE

MATÉRIAUX POREUX

- Dents en carbure rapportées.
- Faible vibration, lame rigide.
- Épaisseur jusqu'à 215 mm (7718.01) et jusqu'à 365 mm (7719.01).



BRIQUE, BÉTON CELLULAIRE, PARPAING

LU		REF		€
280	1	7718.01	3510785435234	39,74
435	1	7719.01	3510785435241	55,85

CLASSIC

LSS.07708

LAME DE SCIE SABRE

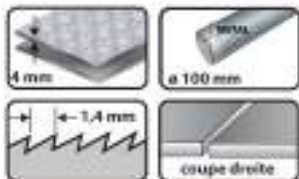

TÔLES MINCES

- Coupe droite de tôles, tubes et profilés.





FA



BI-MÉTAL

ALUMINIUM, ACIER INOXYDABLE, MÉTAL

		REF		€
130	2	7708.02	3510787708022	7,53
130	5	7708.05	3510787708053	16,89

CLASSIC

LSS.07709

LAME DE SCIE SABRE



TÔLES MINCES COUPE FINE

- Coupe droite et fine de tôles, tubes et profilés.





FA



BI-MÉTAL

ALUMINIUM, ACIER INOXYDABLE, MÉTAL

		REF		€
210	5	7709.05	3661589085078	18,57

LAMES DE SCIE SAUTEUSE ET SCIE SABRE

MÉTAL

CLASSIC

LSS.07710

LAME DE SCIE SABRE

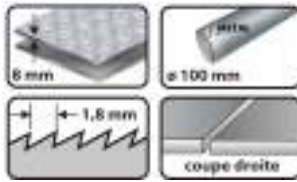

TÔLES ÉPAISSES

- Coupe droite et fine de tôles, tubes et profilés.
- Lame flexible pour agrafer.



FO



BI-MÉTAL

MÉTAL, MÉTAUX NON FERREUX, ALUMINIUM

LU		REF		€
180	5	7710.05	3510787710056	22,86

CLASSIC

LSS.07720

LAME DE SCIE SABRE

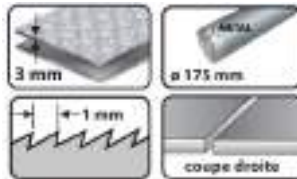

PANNEAUX SANDWICHS

- Coupe droite de panneaux, tôles, tubes et profilés.



FO



BI-MÉTAL

ALUMINIUM, MÉTAL, MATÉRIAUX MULTI-COUCHES OU SANDWICH

LU		REF		€
210	5	7720.05	3661589061300	28,04

MULTI-MATÉRIAUX

CLASSIC

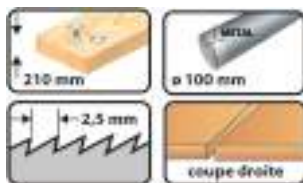

LSS.07705

LAME DE SCIE SABRE

POLYVALENTE POUR CHANTIER

- Coupe droite.
- Réparation de palettes, bois avec clous/métal, tôles métalliques, tuyaux, profilés en aluminium...
- Lame flexible pour agrafer.



FA



BI-MÉTAL

BOIS, BOIS CLOUTÉ, MÉTAL, ALUMINIUM

LU		REF		€
210	2	7705.02	3510787705021	10,65
210	5	7705.05	3510787705052	24,64
210	100	7705	3510787705014	338,67

CLASSIC

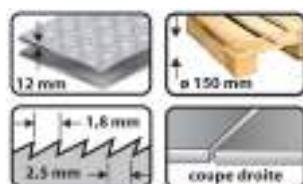

LSS.07713VARIO

LAME DE SCIE SABRE

COUPE AFFLEURANTE

- Coupe rectiligne adaptée aux pièces minces.



Variable



FO



BI-MÉTAL

BOIS CLOUTÉ, BOIS DE PALETTE, MÉTAL, MATIÈRES PLASTIQUES

LU		REF		€
180	5	7713.05VARIO	3510787713057	24,64
180	100	7713VARIO	3510787713996	369,61

CLASSIC

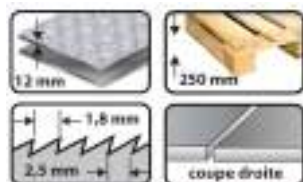

LSS.07714VARIO

LAME DE SCIE SABRE

COUPE AFFLEURANTE GRANDE LONGUEUR

- Coupe rectiligne adaptée aux pièces minces.



Variable



FO



BI-MÉTAL

BOIS CLOUTÉ, BOIS DE PALETTE, MÉTAL, MATIÈRES PLASTIQUES

LU		REF		€
280	5	7714.05VARIO	3510787714054	31,77
280	100	7714VARIO	3510787714993	473,28

LAMES DE SCIE SAUTEUSE ET SCIE SABRE

MULTI-MATÉRIAUX

CLASSIC

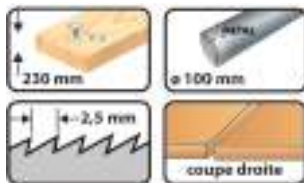

LSS.07711

LAME DE SCIE SABRE

COUPE AFFLEURANTE RAPIDE

- Coupe rectiligne adaptée aux pièces minces.



FA



BI-MÉTAL

BOIS CLOUTÉ, ACIER, ALUMINIUM, MÉTAUX NON FERREUX

LU		REF		€
280	5	7711.05	3510787711053	29,94

CLASSIC



LSS.07715

LAME DE SCIE SABRE

FORTE ÉPAISSEUR

- Lame rigide.
- Coupe droite.



FO



BI-MÉTAL

BOIS CLOUTÉ, BOIS DE PALETTE, MÉTAL, ALUMINIUM

LU		REF		€
205	3	7715.03	3661589085085	21,99

CLASSIC



LSS.07721

LAME DE SCIE SABRE

RÉVERSIBLE

- Double attachement.
- Lame rigide de forte épaisseur.
- Coupe droite et courbe avec attaque plongeante possible.



FO



BI-MÉTAL

BOIS CLOUTÉ, BOIS DE PALETTE, MÉTAL, ALUMINIUM, MATIÈRES PLASTIQUES

LU		REF		€
180	3	7721.03	3661589085092	31,59

MULTI-MATÉRIAUX



LSS.07751

ASSORTIMENT DE 12 LAMES DE SCIE SABRE

- LSS.07716 x4
- LSS.07702 x4
- LSS.07704 x4



	REF		€
12	7750.12	3661589074720	32,54





LSS.07752

ASSORTIMENT DE 12 LAMES DE SCIE SABRE

- LSS.07708 x4
- LSS.07710 x4
- LSS.07705 x4



	REF		€
12	7750.12BIM	3661589074713	44,02





LSS.07750

ASSORTIMENT DE 5 LAMES DE SCIE SABRE

- LSS.07704 x1
- LSS.07708 x2
- LSS.07716 x2



	REF		€
5	7750.05	3661589061317	23,70

LAMES DE SCIE SAUTEUSE ET SCIE SABRE

MULTI-MATÉRIAUX



CLASSIC

LSS.02901

LAME DE SCIE À CHANTOURNER AVEC ERGOTS

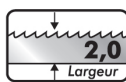

ACIER AU CARBONE MÉTAUX

- Découpe de bois, étain, Corian®, Mica, matières synthétiques.

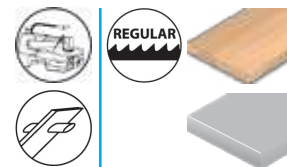

BOIS, ÉTAÏN, CORIAN

LU		REF		€
127	12	2901.12	3510782901121	7,14



CLASSIC

LSS.02902

LAME DE SCIE À CHANTOURNER AVEC ERGOTS

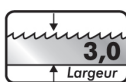

ACIER AU CARBONE MÉTAUX

- Découpe de bois, étain, Corian®, Mica, matières synthétiques.

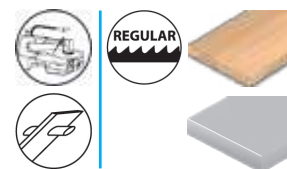

BOIS, ÉTAÏN, CORIAN

LU		REF		€
127	12	2902.12	3510782902128	7,14



CLASSIC

LSS.02903

LAME DE SCIE À CHANTOURNER AVEC ERGOTS

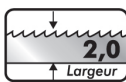

ACIER AU CARBONE MÉTAUX

- Denture «Skip» ou perroquet, pour la découpe de bois, corne, os.

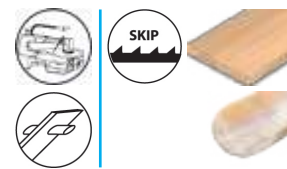

BOIS, MATÉRIAUX NATURELS

LU		REF		€
127	12	2903.12	3510782903125	7,14

MULTI-MATÉRIAUX

CLASSIC

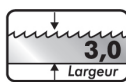

ACIER AU CARBONE MÉTAUX

LSS.02904

LAME DE SCIE À CHANTOURNER AVEC ERGOTS

- Denture «Hook» ou crochet, pour bois, aggloméré >60 mm.

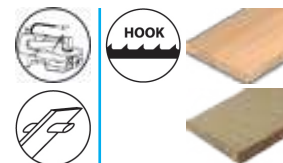

BOIS, AGGLOMÉRÉ

LU		REF		€
127	12	2904.12	3510782901220	7,14

CLASSIC

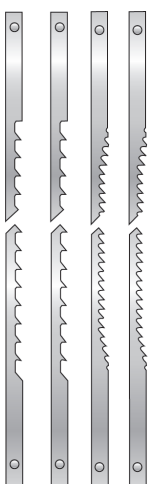

ACIER AU CARBONE MÉTAUX

LSS.02949

ASSORTIMENT DE 12 LAMES DE SCIE À CHANTOURNER AVEC ERGOTS

- 3 lames, largeur 2 mm, épaisseur 0,25 mm. 10 DPC (25TPI) pour le bois, étain, Corian®.
- 3 lames, largeur 3 mm, épaisseur 0,5 mm. 6 DPC (15TPI) pour le bois, étain, Corian®.
- 3 lames, largeur 2 mm, épaisseur 0,25 mm. 7,5 DPC (18,5TPI) pour le bois, corne, os.
- 3 lames, largeur 3 mm, épaisseur 0,5 mm. 2,75 DPC (7TPI) pour le bois et aggloméré >60 mm.



BOIS, ÉTAÏN, CORIAN, MATÉRIAUX NATURELS, AGGLOMÉRÉ

LU		REF		€
127	12	2949.12	3510782949123	7,14

CLASSIC

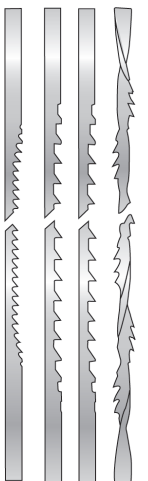

ACIER AU CARBONE MÉTAUX

LSS.02849

ASSORTIMENT DE 12 LAMES DE SCIE À CHANTOURNER

- 3 lames, diamètre 1,05 mm, forme spirale. 16 DPC (40TPI) pour le bois, plastique, os, corne >25 mm.
- 3 lames, largeur 1,8 mm, épaisseur 0,5 mm. 10 DPC (25TPI) pour le bois, étain, Corian®.
- 3 lames, largeur 1,08 mm, épaisseur 0,34 mm. 6,5 DPC (16,5TPI) pour le bois, corne, os >25 mm.
- 3 lames, largeur 1,4 mm, épaisseur 0,42 mm. 5 DPC (12,5TPI) pour le bois, corne, os >50 mm.



BOIS, MATIÈRES PLASTIQUES, MATÉRIAUX NATURELS, ÉTAÏN, CORIAN

LU		REF		€
130	12	2849.12	3510782849126	7,14





info@leman-sa.com

LAMES DE SCIE À RUBAN

 **BOIS MASSIF**

P. 142

 **MÉTAL**

P. 148



CLASSIC  pour les travaux courants et polyvalents.

 **WorkHardWorkFine**

BOIS MASSIF

CLASSIC







LSR.LEM.C75

LAME DE SCIE À RUBAN PRÊTE À L'EMPLOI
ACIER

- Dentées, planées, dressées, tensionnées, avoyées et affûtées.

C75
ACIER

BOIS, PVC

				REF		€
6	1710	0,5	DC4	LEM1	3700501702997	22,30
6	1710	0,5	DC6	LEM2	3700501703109	22,30
10	1710	0,4	DC6	LEM3	3700501703208	22,46
10	1710	0,4	DC8	LEM4	3700501703215	22,46
6	2240	0,5	DC4	LEM6	3700501703239	24,30
6	2240	0,5	DC6	LEM7	3700501703246	24,30
10	2240	0,5	DC6	LEM8	3700501703253	24,51
10	2240	0,5	DC8	LEM9	3700501703260	24,51
15	2240	0,5	DC6	LEM10	3700501703000	24,90
15	2240	0,5	DC8	LEM11	3700501703017	24,90
6	2490	0,5	DC4	LEM14	3700501703048	25,28
6	2490	0,5	DC6	LEM15	3700501703055	27,81
10	2490	0,5	DC6	LEM16	3700501703062	25,54
10	2490	0,5	DC8	LEM17	3700501703079	25,54
15	2490	0,5	DC6	LEM18	3700501703086	25,93
15	2490	0,5	DC8	LEM19	3700501703093	25,93
20	2490	0,5	DC6	LEM20	3700501703116	26,63
20	2490	0,5	DC8	LEM21	3700501703123	26,63
6	2630	0,5	DC4	LEM39	3700501704625	25,82
6	2630	0,5	DC6	LEM40	3700501704632	25,82
10	2630	0,5	DC6	LEM41	3700501704649	26,08
10	2630	0,5	DC8	LEM42	3700501704656	26,08
15	2630	0,5	DC6	LEM43	3700501704663	26,52
15	2630	0,5	DC8	LEM44	3700501704670	26,52
20	2630	0,5	DC6	LEM45	3700501704687	27,21
20	2630	0,5	DC8	LEM46	3700501704694	27,21
6	3454	0,5	DC4	LEM22	3700501703130	28,95
10	3454	0,6	DC6	LEM23	3700501703147	29,33
15	3454	0,6	DC6	LEM24	3700501703154	29,88
20	3454	0,6	DC8	LEM25	3700501703161	31,76
25	3454	0,6	DC8	LEM26	3700501703178	32,69
30	3454	0,6	DC10	LEM27	3700501703185	34,58
40	3454	0,7	DC12	LEM28	3700501703192	36,80

PAS en mm.

BOIS MASSIF

CLASSIC



ACIER
TREMPE
FLEXBACK

LSR.LEM.FLEX

**LAME DE SCIE À RUBAN PRÊTE À L'EMPLOI
ACIER TREMPÉ FLEXBACK**



- Dentées, planées, dressées, tensionnées, avoyées et affûtées.

BOIS, PVC

				REF		€
6	1425	0,36	6	LEM01	3661589078278	21,32
10	1425	0,36	6	LEM02	3661589078292	21,94
10	1710	0,36	6	LEM03	3661589078308	23,19
13	1710	0,65	4	LEM5	3700501703222	23,22
6	2240	0,5	6	LEM12	3700501703024	23,92
13	2240	0,65	4	LEM04	3661589078315	25,51
16	2240	0,5	4	LEM13	3700501703031	27,71
20	2630	0,5	4	LEM48	3700501704717	31,94

Denture TPI = dents par pouce. Non réaffûtable.

BOIS MASSIF

CLASSIC



LSR.129.RLX

LAME DE SCIE À RUBAN ACIER EN ROULEAU











- Dentées, planées, dressées, tensionnées, avoyées et affûtées.

BOIS, BOIS DE CHAUFFAGE

C75

ACIER

			REF		€				REF		€
6	0,5	DC4	129.06.504	3510781290028	3,03	25	0,6	DC6	129.25.606	3510781290325	3,85
6	0,5	DC6	129.06.506	3510781290035	3,03	25	0,6	DC8	129.25.608	3510781290332	3,85
10	0,4	DC6	129.10.406	3510781290042	3,03	25	0,6	DC10	129.25.610	3510781290349	3,85
10	0,5	DC6	129.10.506	3510781290066	3,03	25	0,7	DC8	129.25.708	3510781290356	4,11
10	0,5	DC8	129.10.508	3510781290073	3,03	25	0,7	DC10	129.25.710	3510781290363	4,11
10	0,6	DC6	129.10.606	3510781290080	3,03	30	0,6	DC8	129.30.608	3510781290370	4,23
10	0,6	DC8	129.10.608	3510781290097	3,03	30	0,6	DC10	129.30.610	3510781290387	4,23
15	0,4	DC6	129.15.406	3510781290127	3,03	30	0,7	DC8	129.30.708	3510781290400	4,39
15	0,5	DC6	129.15.506	3510781290141	3,03	30	0,7	DC10	129.30.710	3510781290417	4,39
15	0,5	DC8	129.15.508	3510781290158	3,03	30	0,7	DC12	129.30.712	3510781290424	4,39
15	0,6	DC6	129.15.606	3510781290165	3,03	35	0,6	DC8	129.35.608	3510781290431	4,39
15	0,6	DC8	129.15.608	3510781290172	3,03	35	0,6	DC10	129.35.610	3510781290448	4,39
15	0,7	DC8	129.15.708	3510781290189	3,03	35	0,7	DC10	129.35.710	3510781290462	4,66
15	0,7	DC10	129.15.710	3510781290196	3,03	35	0,7	DC12	129.35.712	3510781290479	4,66
20	0,4	DC6	129.20.406	3510781290202	3,03	35	0,8	DC10	129.35.810	3510781290486	4,76
20	0,5	DC6	129.20.506	3510781290226	3,25	40	0,7	DC10	129.40.710	3510781290493	4,76
20	0,5	DC8	129.20.508	3510781290233	3,25	40	0,7	DC12	129.40.712	3510781290509	4,76
20	0,6	DC6	129.20.606	3510781290240	3,58	40	0,8	DC10	129.40.810	3510781290516	5,04
20	0,6	DC8	129.20.608	3510781290257	3,58	40	0,8	DC12	129.40.812	3510781290523	5,04
20	0,6	DC10	129.20.610	3510781290264	3,58	45	0,8	DC10	129.45.810	3510781290547	6,17
20	0,7	DC8	129.20.708	3510781290271	3,85	45	0,8	DC12	129.45.812	3510781290554	6,17
20	0,7	DC10	129.20.710	3510781290288	3,85	50	0,8	DC12	129.50.812	3510781290561	6,17
25	0,5	DC6	129.25.506	3510781290295	3,58	50	0,8	DC16	129.50.816	3510781290585	6,17
25	0,5	DC8	129.25.508	3510781290301	3,58						
25	0,5	DC10	129.25.510	3510781290318	3,58						

Rouleau de 50 m en boîte dévidoir. Pas en mm.

LAMES DE SCIE À RUBAN

BOIS MASSIF

CLASSIC











LSR.129.PAE

LAME DE SCIE À RUBAN PRÊTE À L'EMPLOI
ACIER



C75
ACIER

BOIS, BOIS DE CHAUFFAGE

			REF		€				REF		€
6	0,5	DC4	12906504	3510785430833	3,85	25	0,5	DC10	12925510	3510785431113	4,66
6	0,5	DC6	12906506	3510785430840	4,23	25	0,6	DC6	12925606	3510785431120	4,94
10	0,4	DC6	12910406	3510785430857	3,96	25	0,6	DC8	12925608	3510785431137	4,94
10	0,5	DC6	12910506	3510785430864	3,96	25	0,6	DC10	12925610	3510785431144	4,94
10	0,5	DC8	12910508	3510785430871	3,96	25	0,7	DC8	12925708	3510785431151	5,31
10	0,6	DC6	12910606	3510785430888	3,96	25	0,7	DC10	12925710	3510785431168	5,31
10	0,6	DC8	12910608	3510785430895	3,96	30	0,6	DC8	12930608	3510785431175	5,47
15	0,4	DC6	12915406	3510785430925	4,11	30	0,6	DC10	12930610	3510785431182	5,47
15	0,5	DC6	12915506	3510785430949	4,11	30	0,7	DC8	12930708	3510785431205	5,47
15	0,5	DC8	12915508	3510785430956	4,11	30	0,7	DC10	12930710	3510785431212	5,47
15	0,6	DC6	12915606	3510785430963	4,11	30	0,7	DC12	12930712	3510785431229	5,47
15	0,6	DC8	12915608	3510785430970	4,11	35	0,6	DC8	12935608	3510785431236	5,64
15	0,7	DC8	12915708	3510785430987	4,11	35	0,6	DC10	12935610	3510785431243	5,64
15	0,7	DC10	12915710	3510785430994	4,11	35	0,7	DC10	12935710	3510785431250	6,02
20	0,4	DC6	12920406	3510785431007	4,11	35	0,7	DC12	12935712	3510785431267	6,02
20	0,5	DC6	12920506	3510785431021	4,39	35	0,8	DC10	12935810	3510785431274	6,12
20	0,5	DC8	12920508	3510785431038	4,39	40	0,7	DC10	12940710	3510785431281	6,12
20	0,6	DC6	12920606	3510785431045	4,66	40	0,7	DC12	12940712	3510785431298	6,12
20	0,6	DC8	12920608	3510785431052	4,66	40	0,8	DC10	12940810	3510785431304	6,45
20	0,6	DC10	12920610	3510785431069	4,66	40	0,8	DC12	12940812	3510785431311	6,45
20	0,7	DC8	12920708	3510785431076	4,94	45	0,8	DC10	12945810	3510785431335	7,85
20	0,7	DC10	12920710	3510785431083	4,94	45	0,8	DC12	12945812	3510785431342	7,85
25	0,5	DC6	12925506	3510785431090	4,66	50	0,8	DC12	12950812	3510785431359	7,80
25	0,5	DC8	12925508	3510785431106	4,66	50	0,8	DC16	12950816	3510785431373	7,80

Prix du ruban prêt à l'emploi = tarif par mètre x Longueur en m + prix fixe soudure & emballage. Tarif soudure : 15,39€

BOIS MASSIF

CLASSIC



ACIER
TREMPE
FLEXBACK





LSR.130.RLX

LAME DE SCIE À RUBAN ACIER TREMPÉ FLEXBACK EN ROULEAU

- Dentées, planées, dressées, tensionnées, avoyées et affûtées.



BOIS, PVC

			REF		€
6	0,36	6	130.06.366TPI	3510785421503	3,68
6	0,5	6	130.06.506TPI	3510785421428	3,41
10	0,36	6	130.10.366TPI	3510785421473	3,96
10	0,5	4	130.10.504TPI	3510785421459	3,96
13	0,36	6	130.13.366TPI	3510785421497	3,96
13	0,65	4	130.13.654TPI	3510785421510	4,11
16	0,36	4	130.16.364TPI	3510785421541	4,94
16	0,5	4	130.16.504TPI	3510785421435	4,94
16	0,65	4	130.16.654TPI	3510785421404	4,94
20	0,5	4	130.20.504TPI	3510785413300	5,79
20	0,8	3	130.20.803TPI	3510785421640	5,84
25	0,65	3	130.25.653TPI	3510785421398	6,87
25	0,9	2	130.25.902TPI	3510785421527	7,15
32	0,9	2	130.32.902TPI	3510785421534	9,59

Rouleau de 50 m en boîte dévidoir.

Denture TPI = dents par pouce. Non réaffûtable.

BOIS MASSIF

CLASSIC



ACIER
TREMPE
FLEXBACK

LSR.130.PAE

LAME DE SCIE À RUBAN PRÊTE À L'EMPLOI
ACIER TREMPÉ FLEXBACK



BOIS, PVC

			REF		€
6	0,36	6	13006366	3510785431397	3,96
6	0,5	6	13006506	3510785431403	3,68
10	0,36	6	13010366	3510785431410	4,39
10	0,5	4	13010504	3510785431427	4,39
13	0,36	6	13013366	3510785431441	4,39
13	0,65	4	13013654	3510785431458	4,39
16	0,36	4	13016364	3510785431465	5,37
16	0,5	4	13016504	3510785431472	5,37
16	0,65	4	13016654	3510785431489	5,37
20	0,5	4	13020504	3510785431496	6,17
20	0,8	3	13020803	3510785431502	6,34
25	0,65	3	13025653	3510785431526	7,43
25	0,9	2	13025902	3510785431533	7,68
32	0,9	2	13032902	3510785431564	10,39

Prix du ruban prêt à l'emploi =
tarif par mètre x Longueur en m + prix fixe soudure & emballage.
Tarif soudure : 15,39€

CLASSIC



HSS
CO8

LSR.LEM.M42

**LAME DE SCIE À RUBAN PRÊTE À L'EMPLOI
BI-MÉTAL M42 À 8% COBALT**

- Haute longévité.



ACIER, ACIER INOXYDABLE, ALUMINIUM, MÉTAUX NON FERREUX

				REF		€
13	1140	0,65	14	LEM214	3661589084927	32,84
13	1140	0,65	6/10	LEM215	3661589084934	32,84
13	1140	0,65	8/12	LEM216	3661589084941	32,84
13	1140	0,65	10/14	LEM217	3661589084958	32,84
13	1435	0,65	14	LEM218	3661589103673	36,99
13	1435	0,65	6/10	LEM219	3661589103680	36,99
13	1435	0,65	8/12	LEM220	3661589103697	36,99
13	1435	0,65	10/14	LEM221	3661589103703	36,99
13	1735	0,65	14	LEM201	3661589064455	46,00
13	1735	0,65	6/10	LEM203	3661589064462	46,00
13	1735	0,65	8/12	LEM204	3661589064479	46,00
13	1735	0,65	10/14	LEM205	3661589064486	46,00
20	2105	0,9	5/8	LEM206	3661589064493	53,74
20	2105	0,9	6/10	LEM207	3661589064509	53,74
20	2105	0,9	8/12	LEM208	3661589064516	53,74
20	2105	0,9	10/14	LEM209	3661589064523	53,74
27	2450	0,9	5/8	LEM210	3661589064530	63,22
27	2450	0,9	6/10	LEM211	3661589064554	63,22
27	2450	0,9	8/12	LEM212	3661589064561	63,22
27	2450	0,9	10/14	LEM213	3661589064578	63,22

Denture TPI = dents par pouce.

LAMES DE SCIE À RUBAN

MÉTAL

CLASSIC



ACIER AU
CARBONE
MÉTAUX

LSR.131.ACC

LAME DE SCIE À RUBAN PRÊTE À L'EMPLOI
ACIER AU CARBONE



MÉTAUX NON FERREUX, PVC, FONTE, BRONZE, CUIVRE, ACIER

			REF		€
6	0,65	10	13106610	3510785431663	4,11
6	0,65	14	13106614	3510785431670	4,11
6	0,65	18	13106618	3661589044495	4,11
10	0,65	8	13110608	3661589044488	4,23
10	0,65	10	13110610	3510785431694	4,23
10	0,65	14	13110614	3510785431700	4,23
10	0,65	18	13110618	3661589044464	4,23
13	0,65	6	13113606	3510785431717	4,49
13	0,65	8	13113608	3661589044457	4,49
13	0,65	10	13113610	3510785431724	4,49
13	0,65	14	13113614	3510785431731	4,49
13	0,65	18	13113618	3661589044433	4,49
16	0,8	6	13116806	3510785431748	5,64
16	0,8	10	13116810	3510785431755	5,64
20	0,8	6	13120806	3510785431762	6,02
20	0,8	10	13120810	3510785431779	6,02
20	0,8	14	13120814	3510785431786	6,02
25	0,9	4	13125904	3661589044396	7,43
25	0,9	6	13125906	3510785431793	7,43
25	0,9	8	13125908	3661589044341	7,43
25	0,9	10	13125910	3661589044358	7,43

Prix du ruban prêt à l'emploi =
tarif par mètre x Longueur en m + prix fixe soudure & emballage.
Tarif soudure : 15,39€. Denture TPI = dents par pouce.

CLASSIC



LSR.132.M42

LAME DE SCIE À RUBAN PRÊTE À L'EMPLOI BI-MÉTAL M42 À 8% COBALT

- Haute longévité.



HSS
CO8

MÉTAUX NON FERREUX, ACIER INOXYDABLE, ALUMINIUM, ACIER

			REF		€
13	0,65	10	13213610	3510785431809	15,05
13	0,65	14	13213614	3510785431816	15,05
13	0,65	18	13213618	3661589044273	15,05
13	0,9	6	13213906	3661589044280	15,05
20	0,9	6	13220906	3661589044266	15,75
27	0,9	6	13227906	3661589044235	17,04
27	0,9	8	13227908	3510785431847	17,04
27	0,9	10	13227910	3510785431854	17,04
34	1,1	6	13234106	3661589044228	20,46

Prix du ruban prêt à l'emploi =
tarif par mètre x Longueur en m + prix fixe soudure & emballage.
Tarif soudure : 15,39€. Denture TPI = dents par pouce.

MÉTAL

CLASSIC



LSR.132.VAR

**LAME DE SCIE À RUBAN PRÊTE À L'EMPLOI
BI-MÉTAL M42 À 8% COBALT**

- Haute longévité.



HSS
CO8

MÉTAUX NON FERREUX, ACIER INOXYDABLE, ALUMINIUM, ACIER

			REF		€
13	0,65	6/10	132136610	3661589044167	15,05
13	0,65	8/12	132136812	3661589044150	15,05
13	0,65	10/14	132136114	3510785431878	15,05
13	0,9	10/14	132139114	3661589044143	16,55
20	0,9	4/6	13220946	3661589044082	17,33
20	0,9	5/8	13220958	3661589044075	17,33
20	0,9	6/10	132209610	3510785431892	15,75
20	0,9	8/12	132209812	3510785431908	15,75
20	0,9	10/14	132209114	3510785431885	15,75
27	0,9	3/4	13227934	3661589044068	17,04
27	0,9	4/6	13227946	3661589044051	17,04
27	0,9	5/8	13227958	3661589044044	17,04
27	0,9	6/10	132279610	3510785431922	17,04
27	0,9	8/12	132279812	3510785431939	17,04
27	0,9	10/14	132279114	3510785431915	17,04
34	1,1	5/8	13234158	3661589044037	20,46
34	1,1	6/10	132341610	3510785431946	20,46

Prix du ruban prêt à l'emploi =
tarif par mètre x Longueur en m + prix fixe soudure & emballage.
Tarif soudure : 15,39€. Denture TPI = dents par pouce.



info@leman-sa.com

PERÇAGE

	BOIS MASSIF	P. 154
	MAÇONNERIE	P. 161
	CARRELAGE	P. 169
	MÉTAL	P. 170
	MULTI-MATÉRIAUX	P. 174

EXPERT  pour les travaux spécialisés et de haute technicité.

CLASSIC  pour les travaux courants et polyvalents.

BOIS MASSIF

EXPERT



HSS

PER.00206

FORET HÉLICOÏDAL HSS BOIS

- Pointe de centrage, 2 traceurs.
- Perçage précis dans les bois durs ou tendres.
- Grande longévité.



BOIS

Ø	3	4	5	6	8	10	12	REF	REF	€
3	3	61	33	1	206.503.00	3661589066299			2,72	
4	4	75	43	1	206.504.00	3661589066305			3,68	
5	5	86	52	1	206.505.00	3661589066312			5,79	
6	6	93	57	1	206.506.00	3661589066329			7,05	
8	8	117	75	1	206.508.00	3661589066336			8,18	
10	10	133	87	1	206.510.00	3661589066343			10,61	
12	10	151	101	1	206.512.00	3661589066350			15,37	

EXPERT



HSS

PER.00206.05

COFFRET DE 5 FORETS HÉLICOÏDAUX HSS BOIS

- Pointe de centrage, 2 traceurs.
- Perçage précis dans les bois durs ou tendres.
- Grande longévité.



BOIS

Ø	REF	REF	€
4/5/6/8/10	206.500.05	3661589066282	34,63

CLASSIC



HM

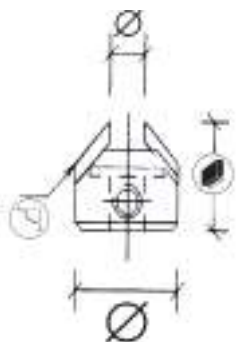

PER.00202

FRAISOIR CARBURE

- Fraisoir 90° à 2 coupes carbure.
- Serrage par vis BTR.
- Adaptation avec mèches réf. 201/206.



BOIS

Ø	4-17	5-17	6-17	8-17	REF	REF	€
4-17	16	1	202.704.00	3510782027104		19,48	
5-17	16	1	202.705.00	3510782027111		19,48	
6-17	16	1	202.706.00	3510782027128		19,48	
8-17	16	1	202.708.00	3510782027142		20,84	

BOIS MASSIF

CLASSIC



WS

PER.00201 FORET HÉLICOÏDAL BOIS



- Pointe de centrage, 2 traceurs.

BOIS

Ø	Traceurs	Longueur	LU	Traceurs	REF	REF	€
3	3	60	30	1	201.503.00	3510782015033	2,06
4	4	75	40	1	201.504.00	3510782015040	2,06
5	5	85	45	1	201.505.00	3510782015057	2,06
6	6	90	50	1	201.506.00	3510782015064	2,33
7	7	105	60	1	201.507.00	3510782015071	2,65
8	8	110	65	1	201.508.00	3510782015088	2,65
9	9	115	70	1	201.509.00	3510782015095	2,76
10	10	120	70	1	201.510.00	3510782015101	2,76
11	10	130	75	1	201.511.00	3510782015118	3,07
12	10	140	85	1	201.512.00	3510782015125	3,07
13	10	150	95	1	201.513.00	3510782015132	3,70
14	10	150	95	1	201.514.00	3510782015149	3,70

CLASSIC



WS

PER.00201.15 COFFRET 15 FORETS HÉLICOÏDAUX BOIS



- Pointe de centrage, 2 traceurs.

BOIS

Ø	REF	REF	€
1 x Ø 7/8,5/9 2 x Ø 3/4/5/6/8/10	201.500.15	3510782016153	30,36

BOIS MASSIF

CLASSIC



HSS



PER.00203

FORET HÉLICOÏDAL + FRAISOIR HSS BOIS

- Pointe de centrage, 2 traceurs.
- Fraisoir à 90° 5 coupes.



BOIS

Ø	3	4	5	6	REF		€
3	3	60	30	1	203.503.00	3510782035109	10,07
4	4	75	40	1	203.504.00	3510782035116	10,07
5	5	85	45	1	203.505.00	3510782035123	10,07
6	6	90	50	1	203.506.00	3510782035130	10,07

CLASSIC



HSS

PER.00203.04

COFFRET DE 4 FORETS HÉLICOÏDAUX + FRAISOIRS BOIS

- 4 forets avec leurs fraisoirs.
- Pointe de centrage, 2 traceurs.
- Fraisoir à 45° 5 coupes.



BOIS

Ø	REF		€
3/4/5/6	203.500.04	3510782035048	31,49

CLASSIC



HSS

PER.00203.T

FORET AVEC FRAISOIR 90° LAME DE TERRASSE

- Perçage et fraisage propre et sans éclat.
- Butée de profondeur réglable.
- Perçage ø 3,6 mm, fraisage ø 12 maxi pour vis à tête fraisée ø 5 - 6 mm.
- Fraisoir à 90° 3 coupes.



BOIS

Ø		REF		€
3,6	1	203.536.90	3661589084750	17,95
Foret de rechange	3,6	201.536.00	3661589084705	2,77

BOIS MASSIF

CLASSIC



WS

PER.00304

MÈCHE PLATE BOIS

- Pointe de centrage, 2 coupes dégageuses, 2 traçoirs.



BOIS

Ø	mm	Q	REF	REF	€
10	150	1	304.510.00	3510783045107	2,76
12	150	1	304.512.00	3510783045121	2,88
14	150	1	304.514.00	3510783045145	2,88
16	150	1	304.516.00	3510783045169	3,14
18	150	1	304.518.00	3510783045183	3,14
20	150	1	304.520.00	3510783045206	3,36
22	150	1	304.522.00	3510783045220	3,47
24	150	1	304.524.00	3510783045244	3,58
25	150	1	304.525.00	3510783045251	3,58
26	150	1	304.526.00	3510783045268	3,58
28	150	1	304.528.00	3510783045282	4,01
30	150	1	304.530.00	3510783045305	4,28
32	150	1	304.532.00	3510783045329	4,49
35	150	1	304.535.00	3510783045350	5,04
38	150	1	304.538.00	3510783045381	5,14

CLASSIC



WS

PER.00304.10

COFFRET DE 10 MÈCHES PLATES BOIS

- Pointe de centrage, 2 coupes dégageuses, 2 traçoirs.



BOIS

Ø	REF	REF	€
6/8/10/14/18/20/22/26/30/35	304.500.10	3661589039828	30,36

CLASSIC



PER.00305

RALLONGE POUR MÈCHE PLATE

- Rallonge de 300 mm.



mm	REF	REF	€
300	305.000.00	3510783050002	8,77

BOIS MASSIF

CLASSIC



WS

PER.00308

MÈCHE HÉLICOÏDALE 6 PANS POUR CHARPENTE BOIS



- Mèche à hélice en cône pour une meilleure évacuation des copeaux.
- Pointe de centrage à vis pour avance automatique.
- Traceur latéral pour une amorce propre.

BOIS

Ø	Ø	LU	Ø	REF		€
6	235	160	1	307.506.00	3510783075005	8,94
8	235	160	1	307.508.00	3510783075012	8,94
10	235	160	1	307.510.00	3510783075029	8,94
12	235	160	1	307.512.00	3510783075036	10,34
14	235	160	1	307.514.00	3510783075050	11,20
16	235	160	1	307.516.00	3510783075074	12,67
18	235	160	1	307.518.00	3510783075098	14,08
20	235	160	1	307.520.00	3510783075104	14,29
22	235	160	1	307.522.00	3510783075111	17,22
24	235	160	1	307.524.00	3510783075128	22,95
26	235	160	1	307.526.00	3510783075135	22,95
30	235	160	1	307.530.00	3510783075159	28,68
6	460	380	1	308.506.00	3661589039880	17,22
8	460	380	1	308.508.00	3661589039897	17,22
10	460	380	1	308.510.00	3510783085004	17,22
12	460	380	1	308.512.00	3510783085189	18,68
14	460	380	1	308.514.00	3510783085028	20,08
16	460	380	1	308.516.00	3510783085035	21,54
17	460	380	1	308.517.00	3661589079633	22,51
18	460	380	1	308.518.00	3510783085042	22,95
20	460	380	1	308.520.00	3510783085172	24,41
22	460	380	1	308.522.00	3510783085073	25,87
24	460	380	1	308.524.00	3510783085080	28,68
26	460	380	1	308.526.00	3510783085097	31,49
30	460	380	1	308.530.00	3510783085110	37,28
6	600	520	1	309.506.00	3661589039866	20,13
8	600	520	1	309.508.00	3661589039873	20,13
10	600	520	1	309.510.00	3661589040060	20,13
12	600	520	1	309.512.00	3510783095003	25,87
14	600	520	1	309.514.00	3510783095010	27,27
16	600	520	1	309.516.00	3510783095027	28,68
18	600	520	1	309.518.00	3510783095034	31,49
20	600	520	1	309.520.00	3510783095041	38,69
22	600	520	1	309.522.00	3510783095058	42,96
24	600	520	1	309.524.00	3510783095065	48,71
26	600	520	1	309.526.00	3510783095072	54,49
30	600	520	1	309.530.00	3510783095096	65,91

BOIS MASSIF

CLASSIC

PER.00308.05 COFFRET DE 5 MÈCHES CHARPENTE BOIS



- Mèche à hélice en cône pour une meilleure évacuation des copeaux.
- Pointe de centrage à vis pour avance automatique.
- Traceur latéral pour une amorce propre.

BOIS

Ø	Icon	REF	Icon	€
6/8/10/12/14	235	307.500.05	3510783075500	52,93
12/14/16/18/20	460	308.500.05	3510783085509	62,99

WS

CLASSIC

PER.00318 MÈCHE HÉLICOÏDALE SDS+ POUR CHARPENTE BOIS



- Mèche à hélice en cône pour une meilleure évacuation des copeaux.
- Pointe de centrage à vis pour avance automatique.
- Traceur latéral pour une amorce propre.

BOIS

Ø	Icon	LU	Icon	REF	Icon	€
10	400	320	1	318.510.00	3510783185018	30,73
12	400	320	1	318.512.00	3510783185025	34,15
14	400	320	1	318.514.00	3510783185032	37,51
16	400	320	1	318.516.00	3510783185049	40,96
18	400	320	1	318.518.00	3510783185056	44,37
20	400	320	1	318.520.00	3510783185063	47,84
22	400	320	1	318.522.00	3510783185070	51,14

WS

BOIS MASSIF

CLASSIC



WS

PER.00205

MÈCHE HÉLICOÏDALE POUR LE TRAITEMENT DES CHARPENTES BOIS



- Mèche à hélice en cône pour une meilleure évacuation des copeaux.
- Pointe de centrage à vis pour avance automatique.
- Traceur latéral pour une amorce propre.

BOIS

Ø	mm	mm	mm	REF	REF	€
9,5	160	100	1	205.509.50	3661589033673	7,74
9,5	200	140	1	205.529.50	3661589040671	8,13

CLASSIC



WS

PER.00211

MÈCHE A BOIS EXTENSIBLE



- Mèche extensible à 2 couteaux interchangeables.

BOIS

Ø	mm	mm	mm	REF	REF	€
15 - 45	8	120	1	211.515.40	3510782115153	41,88

CLASSIC



PER.61700

LOT DE 3 FRAISOIRS BOIS



BOIS

Ø	REF	REF	€
12/16/19	61700.03	3661589043375	11,69

MAÇONNERIE

EXPERT



HM

PER.00624

FORET SDS MAX 4 TAILLANTS BÉTON ARMÉ



- Tête de perçage 4 taillants carbure en Y : puissance de coupe et régularité accrues.
- Goujure plus large pour une meilleure évacuation de la poussière, moins d'échauffements et un perçage plus rapide.
- Risques de blocage limités.

BÉTON ARMÉ, PARPAING, BRIQUE, PIERRE NATURELLE, GRANIT

Ø				REF		€
18	340	200	1	624.340.18	3661589067098	57,41
20	320	200	1	624.320.20	3661589066992	63,15
22	320	200	1	624.320.22	3661589067005	71,21
24	320	200	1	624.320.24	3661589067012	80,51
25	320	200	1	624.320.25	3661589067029	85,76
28	320	200	1	624.320.28	3661589067036	92,47
30	320	200	1	624.320.30	3661589067043	104,11
32	320	200	1	624.320.32	3661589067050	139,92
35	320	200	1	624.320.35	3661589067067	146,90
38	320	200	1	624.320.38	3661589067074	170,76
40	320	200	1	624.320.40	3661589067081	217,03
18	540	400	1	624.540.18	3661589067227	69,11
20	520	400	1	624.520.20	3661589067104	69,42
22	520	400	1	624.520.22	3661589067111	80,18
24	520	400	1	624.520.24	3661589067128	81,44
25	520	400	1	624.520.25	3661589067135	84,84
28	520	400	1	624.520.28	3661589067142	113,40
30	520	400	1	624.520.30	3661589067159	116,82
32	520	400	1	624.520.32	3661589067166	139,97
35	520	400	1	624.520.35	3661589067173	153,56
38	520	400	1	624.520.38	3661589067180	208,31
40	520	400	1	624.520.40	3661589067197	240,13
45	520	400	1	624.520.45	3661589067203	339,74
50	520	400	1	624.520.50	3661589067210	420,52
18	920	800	1	624.920.18	3661589067234	140,58
20	920	800	1	624.920.20	3661589067241	144,74
22	920	800	1	624.920.22	3661589067258	148,03
25	920	800	1	624.920.25	3661589067265	157,62
32	920	800	1	624.920.32	3661589067272	205,12
40	920	800	1	624.920.40	3661589067289	324,04
22	1320	1200	1	624.1320.22	3661589066954	275,13
25	1320	1200	1	624.1320.25	3661589066961	315,17
32	1320	1200	1	624.1320.32	3661589066978	317,61
40	1320	1200	1	624.1320.40	3661589066985	465,80

EXPERT



PER.00629.P
PIC SDS MAX BÉTON

- Tous travaux de démolition.
- Acier taité haute résistance.
- Pointe pyramidale pour une meilleure pénétration.

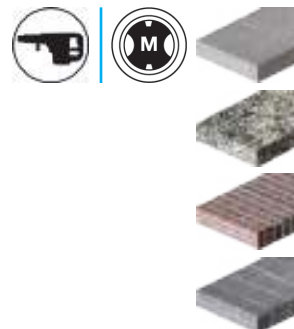

BÉTON, PIERRE NATURELLE, BRIQUE, PARPAING

			REF		€
18	400	1	629.400.18	3661589067326	20,61
18	600	1	629.600.18	3661589067357	28,85

EXPERT



PER.00629.B
BURIN PLAT SDS MAX BÉTON

- Tous travaux de démolition, enlèvement de matière important.
- Acier taité haute résistance.

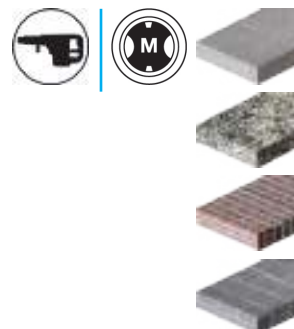

BÉTON, PIERRE NATURELLE, BRIQUE, PARPAING

			REF		€
25	280	1	629.280.25	3661589067302	19,48
25	400	1	629.400.25	3661589067333	23,49
25	600	1	629.600.25	3661589067364	30,53
50	400	1	629.400.50	3661589067340	39,88
75	300	1	629.300.75	3661589067319	42,81

EXPERT



PER.00619
BURIN COUDÉ SDS MAX

- Tous travaux de démolition, enlèvement de matière important.
- Acier taité haute résistance.



BÉTON, PIERRE NATURELLE, BRIQUE, PARPAING

			REF		€
50	400	1	619.400.50	3661589088116	45,29

MAÇONNERIE

CLASSIC



PER.00614
FORET SDS+ 4 TAILLANTS BÉTON ARMÉ

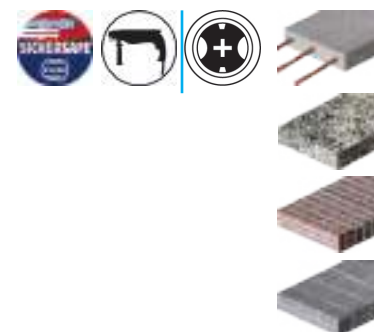

- Travail rapide et performant.
- Tête de perçage 4 taillants carbure avec une géométrie de coupe spécifique.
- Design de la tête en 4 hélices : grande vitesse de perçage et évacuation rapide des poussières.
- Risques de blocage limités.

BÉTON ARMÉ, PARPAING, BRIQUE, PIERRE NATURELLE, GRANIT

Ø				REF		€
5	110	50	1	614.110.05	3661589066640	8,77
6	110	50	1	614.110.06	3661589066657	8,99
8	110	50	1	614.110.08	3661589066664	9,64
5	160	100	1	614.160.05	3661589066671	9,59
6	160	100	1	614.160.06	3661589066688	9,74
6,5	160	100	1	614.160.065	3661589066695	9,97
8	160	100	1	614.160.08	3661589066701	10,29
10	160	100	1	614.160.10	3661589066718	10,72
12	160	100	1	614.160.12	3661589066725	13,10
14	160	100	1	614.160.14	3661589066732	17,75
6	210	150	1	614.210.06	3661589066749	11,75
6,5	210	150	1	614.210.065	3661589066756	12,18
8	210	150	1	614.210.08	3661589066763	12,45
10	210	150	1	614.210.10	3661589066770	12,72
12	210	150	1	614.210.12	3661589066787	14,88
14	210	150	1	614.210.14	3661589066794	20,29
16	210	150	1	614.210.16	3661589066800	28,62
6	260	200	1	614.260.06	3661589066817	13,75
8	260	200	1	614.260.08	3661589066824	14,23
10	260	200	1	614.260.10	3661589066831	15,53
12	260	200	1	614.260.12	3661589066848	18,55
14	260	200	1	614.260.14	3661589066855	23,54
15	260	200	1	614.260.15	3661589066862	31,66
16	260	200	1	614.260.16	3661589066879	32,74
8	460	400	1	614.450.08	3661589066947	32,04
10	450	400	1	614.450.10	3661589066886	32,36
12	450	400	1	614.450.12	3661589066893	32,90
14	450	400	1	614.450.14	3661589066909	36,69
16	450	400	1	614.450.16	3661589066916	46,64
18	450	400	1	614.450.18	3661589066923	55,24
20	450	400	1	614.450.20	3661589066930	62,33

HM

CLASSIC



HM

PER.00603

FORET SDS+ 2 TAILLANTS BÉTON





- Tête de perçage 2 taillants carbure.
- Pointe de centrage pour un positionnement rapide et précis.
- La forme de l'hélice permet d'évacuer rapidement les poussières et réduit l'usure prématurée du foret.



BÉTON, PARPAING, BRIQUE, PIERRE NATURELLE, GRANIT

Ø				REF		€
4	110	50	1	603.110.04	3661589008268	5,31
5	110	50	1	603.110.05	3661589008275	3,91
6	110	50	1	603.110.06	3661589008282	4,01
8	110	50	1	603.110.08	3661589008305	4,17
10	110	150	1	603.110.10	3661589008312	4,81
5	160	100	1	603.160.05	3661589008329	4,39
6	160	100	1	603.160.06	3661589008336	4,49
6,5	160	100	1	603.160.065	3661589066442	4,71
7	160	100	1	603.160.07	3661589066459	4,81
8	160	100	1	603.160.08	3661589008350	4,88
10	160	100	1	603.160.10	3661589008367	5,64
12	160	100	1	603.160.12	3661589008374	7,05
14	160	100	1	603.160.14	3661589008381	8,71
16	160	100	1	603.160.16	3661589008404	11,20
6	210	150	1	603.210.06	3661589008411	6,77
6,5	210	150	1	603.210.065	3661589008428	6,98
8	210	150	1	603.210.08	3661589008435	7,30
10	210	150	1	603.210.10	3661589008442	8,94
12	210	150	1	603.210.12	3661589008459	10,56
14	210	150	1	603.210.14	3661589008466	12,18
15	210	150	1	603.210.15	3661589066466	12,93
16	210	150	1	603.210.16	3661589008480	13,80
18	210	150	1	603.210.18	3661589008497	14,83
6	260	200	1	603.260.06	3661589008527	9,21
6,5	260	200	1	603.260.065	3661589008534	9,41
8	260	200	1	603.260.08	3661589008541	9,53
10	260	200	1	603.260.10	3661589008558	10,12
12	260	200	1	603.260.12	3661589008565	11,80
14	260	200	1	603.260.14	3661589008572	13,47
16	260	200	1	603.260.16	3661589008589	18,40
18	260	200	1	603.260.18	3661589008596	20,03
8	310	250	1	603.310.08	3661589008626	11,37
10	310	250	1	603.310.10	3661589008633	12,67
12	310	250	1	603.310.12	3661589008640	13,70

MAÇONNERIE

				REF		€
14	310	250	1	603.310.14	3661589008657	16,14
16	310	250	1	603.310.16	3661589008664	21,43
18	310	250	1	603.310.18	3661589008671	22,95
20	310	250	1	603.310.20	3661589008688	26,36
8	450	400	1	603.450.08	3661589066473	12,93
10	450	400	1	603.450.10	3661589066480	16,01
12	450	400	1	603.450.12	3661589066497	16,24
14	450	400	1	603.450.14	3661589066503	19,91
16	450	400	1	603.450.16	3661589066510	23,76
18	450	400	1	603.450.18	3661589066527	30,78
20	450	400	1	603.450.20	3661589066534	34,74
22	450	400	1	603.450.22	3661589066541	40,20
24	450	400	1	603.450.24	3661589066558	46,10
25	450	400	1	603.450.25	3661589066565	48,32
10	600	550	1	603.600.10	3661589066572	15,86
12	600	550	1	603.600.12	3661589066589	18,73
14	600	550	1	603.600.14	3661589066596	23,28
16	600	550	1	603.600.16	3661589066602	26,31
18	600	550	1	603.600.18	3661589066619	34,20
20	600	550	1	603.600.20	3661589066626	39,39
10	1000	950	1	603.1000.10	3661589066374	56,00
12	1000	950	1	603.1000.12	3661589066381	58,99
14	1000	950	1	603.1000.14	3661589066398	64,98
16	1000	950	1	603.1000.16	3661589066404	73,37
18	1000	950	1	603.1000.18	3661589066411	80,36
20	1000	950	1	603.1000.20	3661589066428	113,20
25	1000	950	1	603.1000.25	3661589066435	162,48

EXPERT 

PER.00629.A
ADAPTATEUR SDS MAX / SDS+



- Emmanchement SDS MAX pour foret SDS +



BÉTON, PIERRE NATURELLE, BRIQUE, PARPAING

	REF		€
223	629.223.01	3661589067296	119,03



HM

PER.00614.05

**COFFRET DE 5 FORETS SDS+ 4 TAILLANTS
BÉTON ARMÉ**



- Travail rapide et performant.
- Tête de perçage 4 taillants carbure avec une géométrie de coupe spécifique.
- Design de la tête en 4 hélices : grande vitesse de perçage et évacuation rapide des poussières.
- Risques de blocage limités.

BÉTON ARMÉ, PARPAING, BRIQUE, PIERRE NATURELLE, GRANIT

Ø	REF		€
L 110 mm Ø5/6 - L 160 mm Ø 6/8/10	614.000.05	3661589066633	50,92



HM

PER.00603.05

**COFFRET DE 5 FORETS SDS+ 2 TAILLANTS
BÉTON**



- Tête de perçage 2 taillants carbure.
- Pointe de centrage pour un positionnement rapide et précis.
- La forme de l'hélice permet d'évacuer rapidement les poussières et réduit l'usure prématurée du foret.

BÉTON, PARPAING, BRIQUE, PIERRE NATURELLE, GRANIT

Ø	REF		€
L 110 mm Ø5/6 - L 160 mm Ø 6/8/10	603.000.05	3661589084477	27,49

MAÇONNERIE

CLASSIC



PER.00608.P
PIC SDS+

- Tous matériaux de démolition.
- Pointe pyramidale pour une meilleure pénétration.

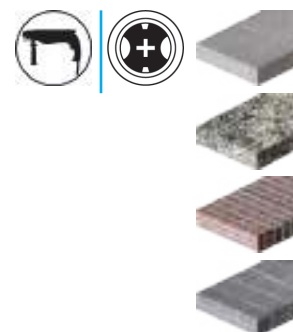

BÉTON, PIERRE NATURELLE, BRIQUE, PARPAING

Ø	L	Q	REF	Code	€
14	250	1	608.250.14	3661589009456	15,05

CLASSIC



PER.00608.B
BURIN PLAT SDS+

- Tous matériaux de démolition.
- Acier taité haute résistance.

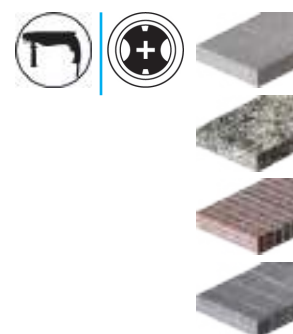

BÉTON, PIERRE NATURELLE, BRIQUE, PARPAING

Ø	L	Q	REF	Code	€
20	250	1	608.250.20	3661589009463	15,43
40	200	1	608.200.40	3661589009449	22,62

CLASSIC



PER.00618
BURIN COUDÉ SDS+

- Tous matériaux de démolition.
- Acier taité haute résistance.

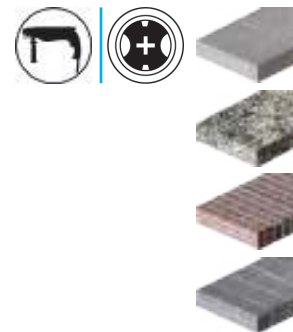

BÉTON, PIERRE NATURELLE, BRIQUE, PARPAING

Ø	L	Q	REF	Code	€
40	250	1	618.250.40	3661589088130	31,00

CLASSIC



HM

PER.00602
FORET CYLINDRIQUE BÉTON

- Foret béton avec plaquette en carbure.
- Affûtage semi-positif.
- Hélice fraisée en «U».
- Finition polie et goujure noire.



BÉTON, PARPAING, BRIQUE, PIERRE NATURELLE, GRANIT, PLÂTRE

Ø	LU	REF	€
3	60	602.060.03	2,55
4	75	602.075.04	2,66
5	85	602.085.05	2,77
6	100	602.100.06	3,12
8	120	602.120.08	3,85
10	120	602.120.10	4,55
5	150	602.150.05	3,91
6	150	602.150.06	4,06
8	150	602.150.08	4,88
10	150	602.150.10	5,69
6	200	602.200.06	5,84
8	200	602.200.08	6,50
10	200	602.200.10	7,48
12	200	602.200.12	8,45

CLASSIC



HM

PER.00602.05
COFFRET DE 5 FORETS CYLINDRIQUES BÉTON

- Foret béton avec plaquette en carbure.
- Affûtage semi-positif.
- Hélice fraisée en «U».
- Finition polie et goujure noire.



BÉTON, PARPAING, BRIQUE, PIERRE NATURELLE, GRANIT, PLÂTRE

Ø	REF	€
4/5/6/8/10	602.000.05	17,32

CARRELAGE

CLASSIC



PER.00606 FORET FAÏENCE, VERRE

- Plaquette carbure affûtage ogive.

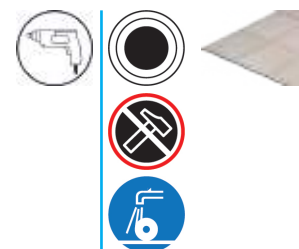

FAÏENCE, CÉRAMIQUE, MIROIR, VERRE

Ø	mm	mm	REF	REF	€
5	58	1	606.065.05	3661589009302	6,50
6	58	1	606.065.06	3661589009319	7,10
8	78	1	606.065.08	3661589009333	8,07
10	98	1	606.065.10	3661589009357	12,51

HM

CLASSIC



PER.00611 FORET CYLINDRIQUE CARRELAGE

- Plaquette carbure affûtage positif.
- Hélice en «L».

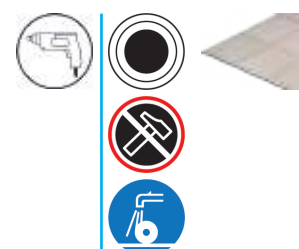

CARRELAGE, CÉRAMIQUE

Ø	mm	mm	mm	REF	REF	€
4	75	40	1	611.075.04	3661589027191	4,17
5	85	45	1	611.085.05	3661589027214	4,55
6	100	55	1	611.100.06	3661589027207	5,09
8	120	65	1	611.120.08	3661589027221	5,64
10	120	65	1	611.120.10	3661589027238	6,55

HM

CLASSIC



PER.00611.05 COFFRET DE 5 FORETS CYLINDRIQUES CARRELAGE

- Plaquette carbure affûtage positif.
- Hélice en «L».

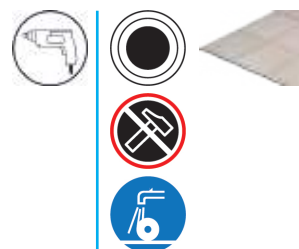

CARRELAGE, CÉRAMIQUE

Ø	REF	REF	€
4/5/6/8/10	611.000.05	3661589039903	23,38

HM

CLASSIC



HSS
CO5

PER.00804

FORET MÉTAL HSS COBALT 5%

- Usage intensif.
- Haute résistance à l'échauffement.
- Foret meulé en acier rapide au Cobalt (5%).
- Affûtage pointe en croix anti-dérage.

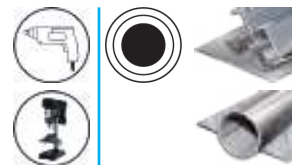

ACIER INOXYDABLE, ACIER, FONTE

Ø		LU		REF		€
2	49	24	1	804.020.01	3661589011893	2,17
2	49	24	10	804.020.10	3661589054562	16,08
2,5	57	30	1	804.025.01	3661589011909	2,22
2,5	57	30	10	804.025.10	3661589054579	16,56
3	61	33	1	804.030.01	3661589011916	2,60
3	61	33	10	804.030.10	3661589054586	19,21
3,5	70	39	1	804.035.01	3661589011923	2,93
3,5	70	39	10	804.035.10	3661589054593	21,92
4	75	43	1	804.040.01	3661589011930	3,25
4	75	43	10	804.040.10	3661589054609	25,00
4,2	75	43	1	804.042.01	3661589011947	3,36
4,2	75	43	10	804.042.10	3661589054616	25,00
4,5	80	47	1	804.045.01	3661589011954	3,36
4,5	80	47	10	804.045.10	3661589054623	25,00
5	86	52	1	804.050.01	3661589011961	4,01
5	86	52	10	804.050.10	3661589054647	29,93
5,5	93	57	1	804.055.01	3661589011978	4,28
6	93	57	1	804.060.01	3661589011985	4,88
6	93	57	10	804.060.10	3661589054630	36,20
6,5	101	63	1	804.065.01	3661589011992	5,25
7	109	69	1	804.070.01	3661589012005	6,55
7	109	69	10	804.070.10	3661589054654	49,13
7,5	109	69	1	804.075.01	3661589012012	7,25
8	117	75	1	804.080.01	3661589012029	8,61
8	117	75	5	804.080.05	3661589054678	32,14
8,5	117	75	1	804.085.01	3661589012036	9,21
9	125	81	1	804.090.01	3661589012043	11,59
9	125	81	5	804.090.05	3661589054685	43,34
9,5	125	81	1	804.095.01	3661589012050	11,80
10	133	87	1	804.100.01	3661589012067	12,77
10	133	87	5	804.100.05	3661589054692	47,78
11	142	94	1	804.110.01	3661589012081	15,86
12	151	101	1	804.120.01	3661589012104	18,78
13	151	101	1	804.130.01	3661589012128	23,81

MÉTAL

CLASSIC



HSS

PER.00802

FORET MÉTAL HSS

- Rapide et polyvalent.
- Foret meulé, acier rapide HSS.
- Angle de pointe à 118°, affûtage en croix.
- Série courte.



ACIER, FONTE

Ø				REF		€
1	34	12	10	802.010.10	3661589011367	7,58
1,5	40	18	10	802.015.10	3661589011374	7,85
2	49	24	1	802.020.01	3661589011084	1,31
2	49	24	10	802.020.10	3661589011381	8,23
2,5	57	30	1	802.025.01	3661589011091	1,36
2,5	57	30	10	802.025.10	3661589011398	8,77
3	61	33	1	802.030.01	3661589011107	1,47
3	61	33	10	802.030.10	3661589011404	9,04
3,2	65	36	1	802.032.01	3661589011114	1,52
3,2	65	36	10	802.032.10	3661589085337	9,41
3,5	70	39	1	802.035.01	3661589011138	1,57
3,5	70	39	10	802.035.10	3661589011411	10,44
4	75	43	1	802.040.01	3661589011145	1,68
4	75	43	10	802.040.10	3661589011428	11,59
4,2	75	43	1	802.042.01	3661589011152	1,68
4,2	75	43	10	802.042.10	3661589011435	13,21
4,5	80	47	1	802.045.01	3661589011169	1,80
4,5	80	47	10	802.045.10	3661589011442	13,21
5	86	52	1	802.050.01	3661589011176	2,12
5	86	52	10	802.050.10	3661589011459	14,88
5,5	93	57	1	802.055.01	3661589011190	2,33
6	93	57	1	802.060.01	3661589011206	2,65
6	93	57	10	802.060.10	3661589011473	19,33
6,5	101	63	1	802.065.01	3661589011213	3,09
7	109	69	1	802.070.01	3661589011237	3,41
7	109	69	10	802.070.10	3661589011497	28,19
7,5	109	69	1	802.075.01	3661589011244	3,73
8	117	75	1	802.080.01	3661589011251	4,17
8	117	75	10	802.080.10	3661589011510	35,93
8,5	117	75	1	802.085.01	3661589011268	4,55
9	125	81	1	802.090.01	3661589011275	5,25
9,5	125	81	1	802.095.01	3661589011282	5,64
10	133	87	1	802.100.01	3661589011299	6,50
10	133	87	10	802.100.10	3661589011558	64,23
10,5	133	87	1	802.105.01	3661589011305	7,25
11	142	94	1	802.110.01	3661589011312	8,18
11,5	142	94	1	802.115.01	3661589011329	8,77
12	151	101	1	802.120.01	3661589011336	9,97
12	151	101	5	802.120.05	3661589011596	45,50
12,5	151	101	1	802.125.01	3661589011343	10,67
13	151	101	1	802.130.01	3661589011350	11,26

CLASSIC



HSS

PER.00812
FORET MÉTAL LAMINÉ HSS AVEC QUEUE RÉDUITE

- Foret laminé, acier rapide HSS, angle affûtage 118°.
- Haute élasticité.
- Queue cylindrique réduite.

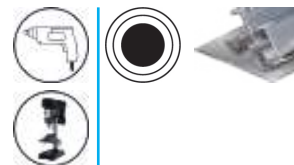

ACIER, FONTE

Ø	Flute	Length	LU	Flute	REF	Code	€
14	9,5	160	108	1	812.140.01	3661589075239	16,45
16	9,5	178	120	1	812.160.01	3661589075246	20,46
18	12,5	191	130	1	812.180.01	3661589075253	27,06
20	12,5	205	140	1	812.200.01	3661589075260	31,81

CLASSIC



HSS

PER.00808
FORET ÉTAGÉ MÉTAL HSS

- Foret étagé acier HSS.
- De 4 à 30 mm de diamètre

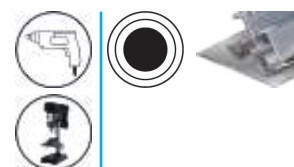

ACIER, FONTE

Ø	Flute	REF	Code	€
4 - 12	1	808.000.412	3661589030535	48,22
4 - 20	1	808.000.420	3661589030542	74,94
4 - 30	1	808.000.430	3661589030559	105,72

CLASSIC



HSS

PER.00809
FRAISE CONIQUE MÉTAL HSS

- Fraise conique 90° HSS.
- 3 taillants.

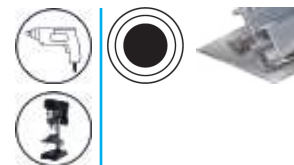

ACIER, FONTE

Ø	Flute	Length	Flute	REF	Code	€
6,3	5	45	1	809.000.063	3661589084996	10,50
8,3	6	50	1	809.000.083	3661589085009	11,69
10,4	6	50	1	809.000.104	3661589085016	13,54
12,4	8	56	1	809.000.124	3661589062970	18,18
16,5	10	60	1	809.000.165	3661589085023	21,27
20,5	10	63	1	809.000.205	3661589085030	31,28

MÉTAL



HSS

PER.00802.19 COFFRET DE 19 FORETS MÉTAL HSS

- Rapide et polyvalent.
- Foret meulé, acier rapide HSS.
- Angle de pointe à 118°, affûtage en croix.
- Série courte.

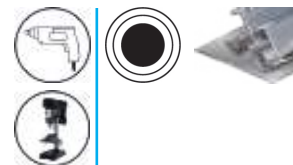

ACIER, FONTE

Ø	REF		€
1/1,5/2/2,5/3/3,5/4/4,5/5/5,5/6/6,5/7/7,5/8/8,5/9/9,5/10	802.000.19	3661589012432	48,22



HSS

PER.00802.25 COFFRET DE 25 FORETS MÉTAL HSS

- Rapide et polyvalent.
- Foret meulé, acier rapide HSS.
- Angle de pointe à 118°, affûtage en croix.
- Série courte.

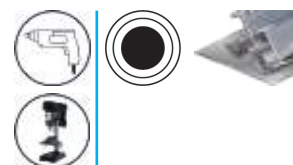

ACIER, FONTE

Ø	REF		€
1/1,5/2/2,5/3/3,5/4/4,5/5/5,5/6/6,5/7/7,5/8/8,5/9/9,5/10/10,5/11/11,5/12/12,5/13	802.000.25	3661589012449	99,02



HSS

TITANE

PER.00803 COFFRET DE 13 FORETS MÉTAL HSS TITANE

- Usage intensif.
- Revêtement titane haute résistance à l'échauffement.

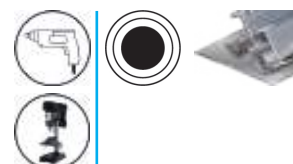

ACIER, FONTE

Ø	REF		€
1,5/2/2,5/3/3,5/4/4,2/4,5/5/5,5/6/6,5	803.000.13	3661589050205	31,39

MÉTAL

CLASSIC



HSS

PER.00808.03
COFFRET DE 3 FORETS ÉTAGÉS MÉTAL HSS

- Foret étagé acier HSS.
- De 4 à 30 mm de diamètre

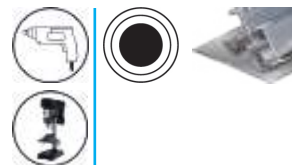

ACIER, FONTE

∅	REF		€
4 - 12/6 - 20/6 - 30	808.000.03	3661589013767	212,70

CLASSIC



HSS

PER.00808.06
COFFRET DE 6 FRAISES CONIQUES MÉTAL HSS

- Fraise conique 90° HSS.
- 3 taillants.

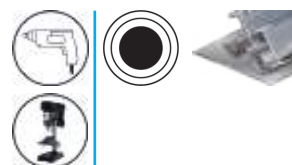

ACIER, FONTE

∅	REF		€
6,3/8,3/10,4/12,4/16,5/20,5	808.000.06	3661589013781	107,03

MULTI-MATÉRIAUX

CLASSIC



HM

PER.00702.05
COFFRET DE 5 FORETS CYLINDRIQUES MULTI-MATÉRIAUX

- Foret polyvalent pour un résultat optimal dans une multitude de matériaux.
- Évacuation rapide de la poussière et des copeaux.
- Grande longévité.
- Plaquette carbure rectifiée au diamant.



ACIER, BOIS, BRIQUE, CARRELAGE, PVC

∅	REF		€
4/5/6/8/10	702.000.05	3661589067371	33,66





info@leman-sa.com

PERÇAGE SPÉCIAL

-  **BOIS MASSIF** P. 178
-  **PANNEAUX & DÉRIVÉS DU BOIS** P. 181
-  **MÉTAL** P. 190

EXPERT  pour les travaux spécialisés et de haute technicité.

CLASSIC  pour les travaux courants et polyvalents.



BOIS MASSIF

CLASSIC

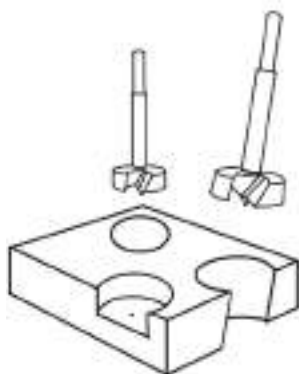

PRS.00100.5

MÈCHE À FAÇONNER EN ACIER À FOND PLAT

- Pointe de centrage, 2 coupes dégageuses, 2 traçoirs.

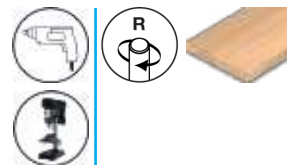

BOIS

Ø	Ø	Ø	REF		€
8	8	90	100.508.00	3661589078797	12,61
10	8	90	100.510.00	3510781005103	13,14
12	8	90	100.512.00	3510781005110	13,66
15	8	90	100.515.00	3510781005134	15,34
20	8	90	100.520.00	3510781005165	18,49
25	8	90	100.525.00	3510781005202	21,33
30	8	90	100.530.00	3510781005233	29,63
35	10	90	100.535.00	3510781005257	29,21
40	10	90	100.540.00	3510781005271	35,30
45	10	90	100.545.00	3510781005288	50,82
50	10	90	100.550.00	3510781005295	50,01

CLASSIC



PRS.00102.5

MÈCHE À FAÇONNER ACIER À COUPE PÉRIPHÉRIQUE DÉCOMPOSÉE

- Pointe de centrage, 2 coupes dégageuses, coupe périphérique décomposée.
- Perçage grands diamètres, pour aménagement d'espaces verts, clôtures...

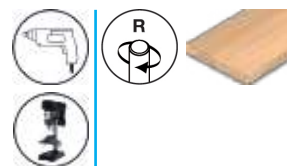

BOIS

Ø	Ø	Ø	REF		€
60	12,5	160	102.560.00	3661589076229	61,36
80	12,5	160	102.580.00	3661589076236	87,67
100	12,5	160	102.5100.00	3661589076243	125,59
120	12,5	160	102.5120.00	3661589076250	176,30
125	12,5	160	102.5125.00	3661589076267	190,83

BOIS MASSIF

CLASSIC



WS

PRS.00200

MÈCHE À BOUCHONNER EN ACIER WS

- Mèche à couteaux multiples pour la réalisation de bouchons.

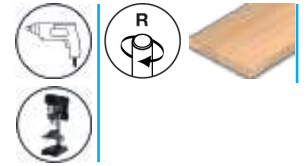

BOIS

Ø	mm	mm	mm	REF		€
8	13	140	4	200.508.00	3510782005010	55,62
10	13	140	4	200.510.00	3510782005027	56,00
12	13	140	4	200.512.00	3510782005034	56,32
15	13	140	4	200.515.00	3510782005041	58,66
20	13	140	4	200.520.00	3510782005058	63,15
25	13	140	5	200.525.00	3510782005065	69,53
30	13	140	5	200.530.00	3510782005072	92,78
35	16	140	6	200.535.00	3510782005089	102,34
40	16	140	6	200.540.00	3510782005096	155,45
45	16	140	6	200.545.00	3510782005102	176,24
50	16	140	6	200.550.00	3510782005119	213,67

CLASSIC



WS

PRS.00200.04

COFFRET DE 4 MÈCHES À BOUCHONNER

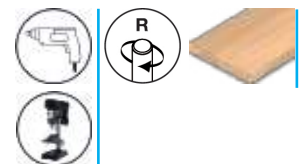

BOIS

Ø	mm	mm	REF		€
6/10/13/16	10		200.500.04	3661589086662	8,08

BOIS MASSIF



WS

PRS.00200.05
COFFRET 5 MÈCHES À BOUCHONNER

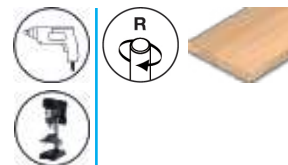

BOIS				
Ø	Q	REF		€
15/20/25/30/35	13	200.500.05	3510782005508	117,14



HM

PRS.00100.7
COFFRET DE 5 MÈCHES À FAÇONNER À FOND PLAT

- 5 mèches à percer carbure avec pointe de centrage, 2 coupes dégageuses, 2 traçoirs.

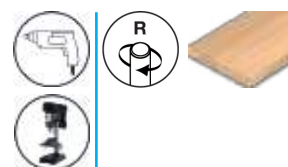

BOIS				
Ø	Q	REF		€
15/20/25/30/35	10	100.700.05	3510781000054	63,75



WS

PRS.00210
COFFRET 4 MÈCHES À BOUCHONNER + 4 MÈCHES À FAÇONNER À FOND PLAT

- Mèche à bouchonner en queue de 13 mm.
- Mèche à façonner en queue de 10 mm.

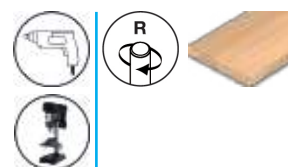

BOIS				
Ø	Q	REF		€
8/10/12/15	10/13	210.500.08	3510782105000	75,43

PANNEAUX ET DÉRIVÉS DU BOIS

CLASSIC



HM

PRS.00100

MÈCHE À FAÇONNER AU CARBURE À FOND PLAT

- Pointe de centrage, 2 coupes dégageuses, 2 traçoirs.

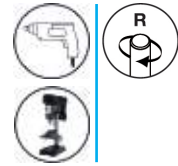

BOIS, MÉLAMINÉ, MDF/HDF, AGGLOMÉRÉ

Ø	Ø	Ø	REF		€
8	10	90	100.708.00	3510781007107	45,12
10	10	90	100.710.00	3510781007114	45,12
12	10	90	100.712.00	3510781007121	45,12
14	10	90	100.714.00	3510781007138	45,12
15	10	90	100.715.00	3510781007145	45,12
16	10	90	100.716.00	3510781007152	45,12
18	10	90	100.718.00	3510781007169	45,12
20	10	90	100.720.00	3510781007176	45,12
22	10	90	100.722.00	3510781007206	45,12
23	10	90	100.723.00	3510781007213	55,91
24	10	90	100.724.00	3510781007220	48,10
25	10	90	100.725.00	3510781007237	42,11
26	10	90	100.726.00	3510781007244	49,08
28	10	90	100.728.00	3510781007251	49,08
30	10	90	100.730.00	3510781007268	47,56
32	10	90	100.732.00	3510781007275	50,59
34	10	90	100.734.00	3510781007305	50,59
35	10	90	100.735.00	3510781007312	50,59
35	8	76	108.735.00	3510781087352	54,16
36	10	90	100.736.00	3510781007329	62,66
38	10	90	100.738.00	3510781007336	53,68
40	10	90	100.740.00	3510781007343	53,68
45	10	90	100.745.00	3510781007350	68,34
50	10	90	100.750.00	3510781007367	95,65

PANNEAUX ET DÉRIVÉS DU BOIS

CLASSIC

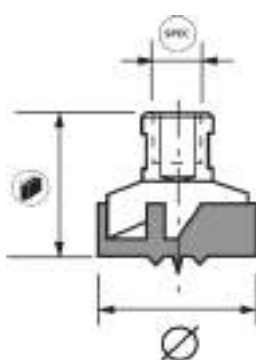

PRS.00101

TÊTE DE MÈCHE À FAÇONNER

- Tête de mèche à façonner avec filetage intérieur pour montage de la queue vissée.
- Pointe de centrage, 2 coupes dégageuses, 2 traçoirs.

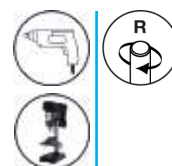

BOIS, MÉLAMINÉ, MDF/HDF, AGGLOMÉRÉ

HM

SPEC.	Ø	⊠	REF	⊠	€
M12	20	30	101.720.00	3510781017205	52,49
M12	25	30	101.725.00	3510781017250	57,96
M12	30	30	101.730.00	3510781017304	63,80
M12	35	30	101.735.00	3510781017359	67,65
M12	40	30	101.740.00	3510781017403	85,98
M12	45	30	101.745.00	3510781017458	108,06
M12	50	30	101.750.00	3510781017502	117,20
M12	55	42	101.755.00	3510781017557	130,41
M12	60	42	101.760.00	3510781017601	174,60
M12	65	42	101.765.00	3510781017656	196,68
M12	70	42	101.770.00	3510781017700	221,41
M16	80	42	101.780.00	3510781017809	263,12

CLASSIC



PRS.00890

MANDRIN FILETÉ (POUR MONTAGE SUR TÊTE À FAÇONNER CAT. 101)

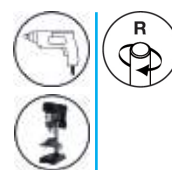

	Ø	⊠	REF	⊠	€
M12	8	50	890.006.01	3510788906014	16,84
M12	10	50	890.006.02	3510788906021	16,84
M12	10	100	890.006.03	3510788906038	21,49
M12	12	50	890.006.04	3510788906045	16,84
M12	13	100	890.006.06	3510788906069	21,49
M12	16	100	890.006.08	3510788906083	21,49
M16	16	100	890.006.10	3510785424290	46,10

PANNEAUX ET DÉRIVÉS DU BOIS

CLASSIC

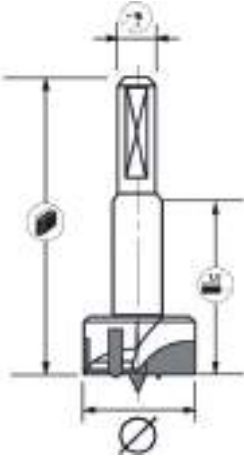

PRS.00102 MÈCHE À FAÇONNER

- Pointe de centrage, 2 coupes dégageuses, 2 traçoirs.
- Queue cylindrique $\varnothing 10 \times 26$ avec méplat de serrage et vis de réglage.
- RPM : 3 000/6 000.

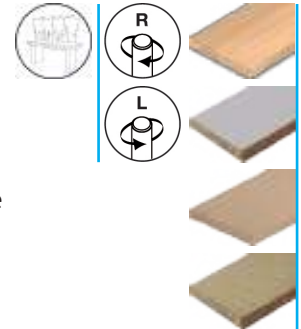

HM

BOIS, MÉLAMINÉ, MDF/HDF, AGGLOMÉRÉ

\varnothing				REF		€
15	57	30	R	102.715.00	3510781027105	41,40
15	57	30	L	102.715.01	3510781027303	41,40
18	57	30	R	102.718.00	3510781027129	41,40
20	57	30	R	102.720.00	3510781027136	41,40
20	57	30	L	102.720.01	3510781027334	41,40
25	57	30	R	102.725.00	3510781027150	43,06
26	57	30	R	102.726.00	3661589076311	43,06
30	57	30	R	102.730.00	3510781027167	47,56
35	57	30	R	102.735.00	3510781027181	49,08
35	57	30	L	102.735.01	3510781027389	49,08
40	57	30	R	102.740.00	3510781027198	53,68
15	70	43	R	102.715.70	3510781027501	47,02
20	70	43	R	102.720.70	3510781027525	48,22
25	70	43	R	102.725.70	3510781027532	49,62
35	70	43	R	102.735.70	3510781027556	57,96
35	70	43	L	102.735.71	3510781027655	57,96

PANNEAUX ET DÉRIVÉS DU BOIS

EXPERT



HM

PRS.00265

MÈCHE À TOURILLONS CARBURE

- Mèche à percer pour trou borgne.
- Queue cylindrique $\varnothing 10 \times 27$ avec méplat de serrage et vis de réglage.
- Convient pour machines C.N.C. RPM : 4 000/8 000.
- 2 hélices, traceurs arrondis et pointe de centrage renforcée.
- Carbure spécial, excellente finition et longue durée de coupe.

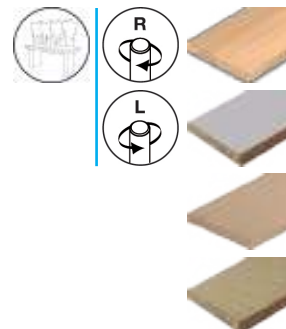

BOIS, MÉLAMINÉ, MDF/HDF, AGGLOMÉRÉ

				REF		€
5	57	27	R	265.705.00	3510782657011	23,11
5	57	27	L	265.705.01	3510782657110	23,11
6	57	27	R	265.706.00	3510782657028	25,21
6	57	27	L	265.706.01	3510782657127	25,21
8	57	27	R	265.708.00	3510782657035	26,27
8	57	27	L	265.708.01	3510783657133	26,27
10	57	27	R	265.710.00	3510782657042	28,37
10	57	27	L	265.710.01	3510782657141	28,37
12	57	27	R	265.712.00	3661589061669	33,62
12	57	27	L	265.712.01	3661589061676	33,62
5	70	35	R	275.705.00	3510782757018	25,21
5	70	35	L	275.705.01	3510782757117	25,21
6	70	35	R	275.706.00	3510782757025	26,27
6	70	35	L	275.706.01	3510782757124	26,27
8	70	35	R	275.708.00	3510782757032	27,32
8	70	35	L	275.708.01	3510782757131	27,32
10	70	35	R	275.710.00	3510782757049	29,42
10	70	35	L	275.710.01	3510782757148	29,42
12	70	35	R	275.712.00	3661589061683	34,67
12	70	35	L	275.712.01	3661589061690	34,67

PANNEAUX ET DÉRIVÉS DU BOIS

CLASSIC



PRS.00225

MÈCHE À TOURILLONS CARBURE

- Mèche à percer pour trou borgne.
- Queue cylindrique \varnothing 10 x 25 avec méplat de serrage et vis de réglage.
- RPM : 3 000/6 000.

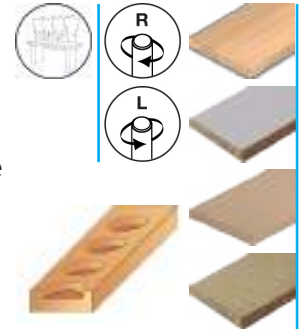

BOIS, MÉLAMINÉ, MDF/HDF, AGGLOMÉRÉ

HM

\varnothing				REF		€
5	57	27	R	225.705.00	3510782257112	19,43
5	57	27	L	225.705.01	3510782257310	19,43
7	57	27	R	225.707.00	3510782257150	21,49
7	57	27	L	225.707.01	3510782257358	21,49
8	57	27	R	225.708.00	3510782257167	21,49
8	57	27	L	225.708.01	3510782257365	21,49
10	57	27	R	225.710.00	3510782257198	23,22
10	57	27	L	225.710.01	3510782257396	23,22
12	57	27	R	225.712.00	3510782257211	26,13
12	57	27	L	225.712.01	3510782257419	26,13
5	70	35	R	245.705.00	3510782457116	18,35
5	70	35	L	245.705.01	3510782457314	18,35
8	70	35	R	245.708.00	3510782457147	22,95
8	70	35	L	245.708.01	3510782457345	22,95
8,2	70	35	R	245.708.20	3510782457154	27,49
8,2	70	35	L	245.708.21	3510782457352	27,49
10	70	35	R	245.710.00	3510782457178	25,98
10	70	35	L	245.710.01	3510782457376	25,98
12	70	35	R	245.712.00	3510782457192	29,12
12	70	35	L	245.712.01	3510782457390	29,12

PANNEAUX ET DÉRIVÉS DU BOIS



HM
MONOBLOC

PRS.00235

MÈCHE À TOURILLONS CARBURE MONOBLOC MICRO-GRAIN

- Mèche à percer pour trou borgne.
- Queue cylindrique \varnothing 10 x 30 avec méplat de serrage et vis de réglage.
- Convient pour machines C.N.C.
- RPM : 4 000/8 000.

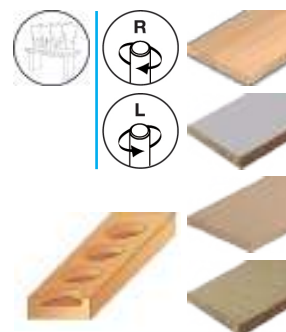

BOIS, MÉLAMINÉ, MDF/HDF, AGGLOMÉRÉ

				REF		€
3	57	25	R	235.703.00	3510785424191	27,06
3	57	25	L	235.703.01	3510785424214	27,06
5	57	25	R	235.705.00	3510785424184	32,09
5	57	25	L	235.705.01	3510785424177	32,09
8	57	25	R	235.708.00	3510785424245	38,31
8	57	25	L	235.708.01	3510785424269	38,31
3	70	35	R	255.703.00	3510785424382	31,44
3	70	35	L	255.703.01	3510785424399	31,44
5	70	35	R	255.705.00	3510785424337	35,50
5	70	35	L	255.705.01	3510785424344	35,50
8	70	35	R	255.708.00	3510785424320	39,67
8	70	35	L	255.708.01	3510785424313	39,67

PANNEAUX ET DÉRIVÉS DU BOIS

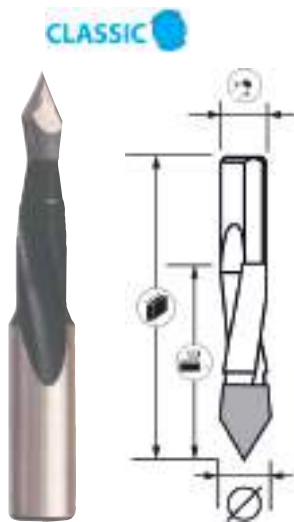

HM

PRS.00227 MÈCHE À PERCER CARBURE

- Mèche à percer en pointe à 60° pour trou débouchant.
- Queue cylindrique $\varnothing 10 \times 30$ avec méplat de serrage et vis de réglage.
- RPM : 3 000/6 000.

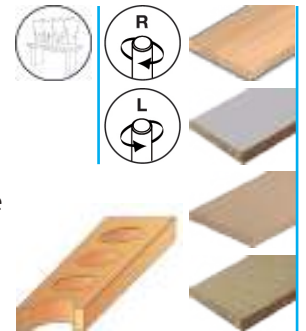

BOIS, MÉLAMINÉ, MDF/HDF, AGGLOMÉRÉ

\varnothing	Length	Flute	Rotation	REF	Code	€
5	70	35	R	227.705.00	3510782277103	33,22
5	70	35	L	227.705.01	3510782277202	33,22
8	70	35	R	227.708.00	3510782277127	35,87
8	70	35	L	227.708.01	3510782277226	35,87



HM
MONOBLOC

PRS.00257 MÈCHE À PERCER CARBURE MONOBLOC MICRO-GRAIN

- Mèche à percer en pointe à 60° pour trou débouchant.
- Queue cylindrique $\varnothing 10 \times 30$ avec méplat de serrage et vis de réglage.
- Convient pour machines C.N.C.
- RPM : 4 000/8 000.
- Coupe sans éclat de panneaux MDF, revêtus, non revêtus et bois.

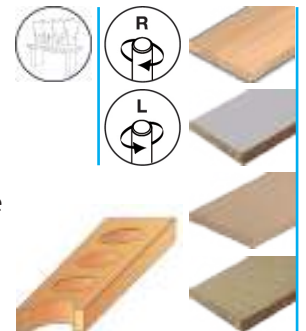

BOIS, MÉLAMINÉ, MDF/HDF, AGGLOMÉRÉ

\varnothing	Length	Flute	Rotation	REF	Code	€
3	70	35	R	257.703.00	3510785424351	32,84
3	70	35	L	257.703.01	3510785424375	32,84
4	70	35	R	257.704.00	3510785424207	35,50
4	70	35	L	257.704.01	3510785424276	35,50
5	70	35	R	257.705.00	3510785424221	38,31
5	70	35	L	257.705.01	3510785424306	38,31
8	70	35	R	257.708.00	3510785424238	48,64
8	70	35	L	257.708.01	3510785424252	48,64

PANNEAUX ET DÉRIVÉS DU BOIS

EXPERT

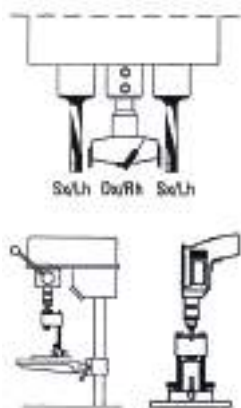

PRS.04280

SUPPORT DE PERÇAGE POUR CHARNIÈRES ET POIGNÉES

- Le système de perçage TRIMATIC® est muni d'une tête à trois broches.
- Permet de réaliser les perçages de tous modèles de charnières et poignées.
- Peut-être utilisé avec tous les types de perceuses manuelles et perceuses à colonnes.
- Support de perçage livré sans les mèches.



BOIS, MÉLAMINÉ, MDF/HDF, AGGLOMÉRÉ

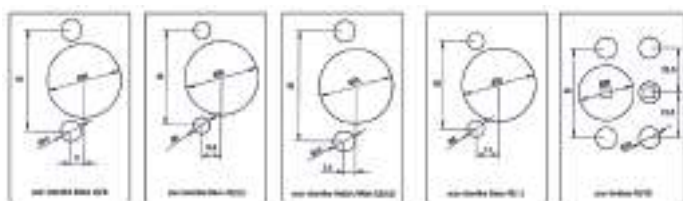

SPEC.	REF		€
SALICE - 48/6	4280.4860.00	3661589041241	443,67
BLUM - 45/9,5	4280.4595.00	3661589041258	443,67
HETTICH / WÜRTH - 52/5,5	4280.5255.00	3661589041265	519,42
GRASS - 42/11	4280.4211.00	3661589041272	519,42
FENÊTRE - 43/00	4280.4300.00	3661589041289	443,67

CLASSIC



PRS.100.02

KIT MÈCHE CHARNIÈRE INVISIBLE Ø 35 MM

- Mèche ø 35 en acier à coupe périphérique décomposée.
- Livré avec gabarit de positionnement (réversible ø 35 / ø 26)

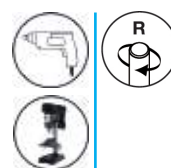

BOIS, MÉLAMINÉ, MDF/HDF, AGGLOMÉRÉ

		REF		€
35	10	100.500.02	3661589043399	20,56

PANNEAUX ET DÉRIVÉS DU BOIS



PRS.00228

MÈCHE À TOURILLONS CARBURE POUR MAFELL

- Mèche à percer pour trou borgne.
- Queue cylindrique \varnothing 8 x 20 avec méplat de serrage.

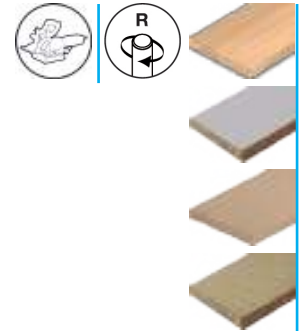

BOIS, MÉLAMINÉ, MDF/HDF, AGGLOMÉRÉ

			REF		€
5	58	38	228.705.00	3510782287010	25,87
6	58	38	228.706.00	3510782287027	25,87
8	58	38	228.708.00	3510782287034	27,06
10	58	38	228.710.00	3510782287041	30,78
12	58	38	228.712.00	3510782287058	33,22



PRS.00271

MÈCHE D'ASSEMBLAGE AU CARBURE POUR FESTOOL DOMINO

- 2 coupes hélicoïdales au carbure.
- Queue cylindrique avec filetage intérieur de M 6 x 0,75.
- Fraisage et perçage.

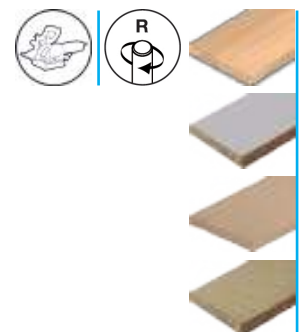

BOIS, MÉLAMINÉ, MDF/HDF, AGGLOMÉRÉ

			REF		€
5	49	25	271.705.00	3510782717012	37,72
6	49	25	271.706.00	3510782717029	38,96
8	49	25	271.708.00	3510782717036	40,32
10	49	25	271.710.00	3510782717043	45,50

CLASSIC



HSS

PRS.00505

MÈCHE DE PRÉCISION UNE LÈVRE



- Fraise 1 coupe hélicoïdale avec queue décollétée.
- Convient pour l'aluminium et les matières plastiques.

ALUMINIUM, PVC

Ø	Flutes	Longueur	Longueur de coupe	REF	Code	€
3	8	60	12	505.503.12	3510785055104	13,70
4	8	60	12	505.504.12	3510785055111	13,70
5	8	60	12	505.505.12	3510785055128	13,70
5	8	60	18	505.505.18	3510785055135	13,70
5	8	90	25	505.505.25	3510785055197	27,34
5	8	100	40	505.505.40	3510785055159	32,84
5	8	120	14	505.505.14	3510785055166	17,80
6	8	60	14	505.506.14	3510785055173	13,70
7	8	60	14	505.507.14	3510785055203	19,16
8	8	80	14	505.508.14	3510785055210	13,70
8	8	80	25	505.508.25	3510785055302	21,36
8	8	100	14	505.508.15	3510785055296	19,69
8	8	120	14	505.518.14	3510785055227	17,80
10	8	80	14	505.510.14	3510785055241	16,39
10	10	120	14	510.511.14	3510785055265	27,34
12	8	80	14	505.512.14	3510785055272	20,51

MÉTAL

CLASSIC



HSS

PR.00509

MÈCHE DE PRÉCISION UNE LÈVRE



- Fraise 1 coupe hélicoïdale avec queue décollétée.
- Convient pour l'aluminium et les matières plastiques.

ALUMINIUM, PVC

Ø	Flutes	Longueur	Longueur de coupe	REF	Code produit	€
4	8	90	16/45	509.504.45	3510785095100	24,62
5	8	80	18/35	509.505.35	3510785095117	17,80
5	8	90	16/45	509.505.45	3510785095179	17,80
5	8	100	25/55	509.505.55	3510785095186	27,34
6	8	80	14/35	509.506.35	3510785424160	20,51
6	8	90	16/45	509.506.45	3510785095124	24,62
8	8	80	14/54	509.508.54	3510785095131	17,80
8	8	100	14/68	509.508.68	3510785095148	27,34
10	10	85	14/65	509.510.65	3510785095155	25,98

CLASSIC



HSS

PR.00504

MÈCHE DE PRÉCISION UNE LÈVRE



- Fraise 1 coupe hélicoïdale pour usinage de gabarits en acier.

MÉTAL

Ø	Flutes	Longueur	Longueur de coupe	REF	Code produit	€
5	8	60	12	504.505.12	3510785045105	19,16
8	8	80	14	504.508.14	3510785045112	21,87



info@leman-sa.com

DÉFONÇAGE

	BOIS MASSIF	P. 194
	PANNEAUX & DÉRIVÉS DU BOIS	P. 219
	MÉTAL	P. 235
	ACCESSOIRES	P. 236

EXPERT  pour les travaux spécialisés et de haute technicité.

CLASSIC  pour les travaux courants et polyvalents.

BOIS MASSIF

CLASSIC

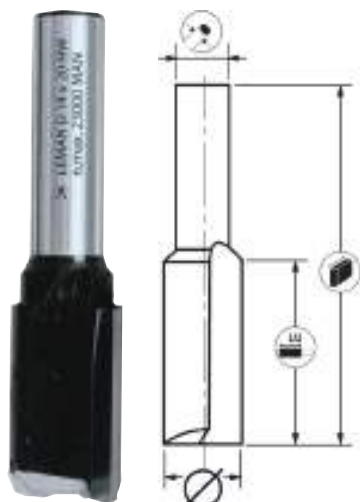

HM

EN847-1

DEF.40.68

MÈCHE À RAINER DROITE



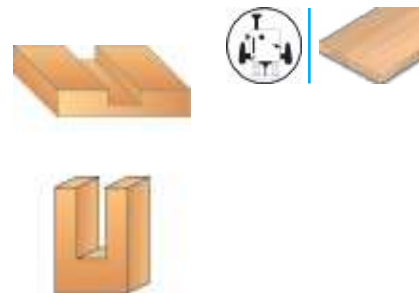



- 2 coupes latérales + coupe frontale.
- Assemblage rainure, languette et coupe plongeante dans le bois.



BOIS

Ø	Icon	Icon	Icon	Icon	REF	Icon	€
3	6	50	10	2	406.703.00	3510784067191	27,45
4	6	50	12	2	406.704.00	3510784067108	25,70
5	6	50	15	2	406.705.00	3510784067115	25,70
6	6	55	20	2	406.706.00	3510784067122	25,70
7	6	55	20	2	406.707.00	3510784067139	26,95
8	6	55	20	2	406.708.00	3510784067146	27,06
8	6	65	30	2	406.708.30	3510784067153	31,23
10	6	55	20	2+1	406.710.00	3510784067177	28,36
10	6	65	30	2+1	406.710.30	3510784067207	31,06
12	6	55	20	2+1	406.712.00	3510784067221	28,36
12	6	65	30	2+1	406.712.30	3510784067238	31,06
14	6	55	20	2+1	406.714.00	3510784067252	31,06
15	6	55	20	2+1	406.715.00	3510784067269	31,06
16	6	55	20	2+1	406.716.00	3510784067306	31,06
18	6	55	20	2+1	406.718.00	3510784067320	32,52
20	6	55	20	2+1	406.720.00	3510784067344	33,87
22	6	55	20	2+1	406.722.00	3510784067351	33,87
25	6	55	20	2+1	406.725.00	3510784067368	35,33
3	8	50	10	2	408.703.00	3510784087090	27,45
4	8	50	12	2	408.704.00	3510784087106	28,27
5	8	50	15	2	408.705.00	3510784087113	25,70
6	8	55	20	2	408.706.00	3510784087120	25,70
7	8	55	20	2	408.707.00	3510784087137	26,95
8	8	55	20	2	408.708.00	3510784087144	27,06
8	8	65	30	2	408.708.30	3510784087151	31,23
9	8	55	20	2	408.709.00	3510784087168	28,36
10	8	55	20	2+1	408.710.00	3510784087175	28,36
10	8	65	30	2+1	408.710.30	3510784087205	31,06
10	8	110	40	2+1	408.710.40EL	3510785401802	42,21
11	8	55	20	2+1	408.711.00	3510784087212	28,36

BOIS MASSIF

					REF		€
12	8	55	20	2+1	408.712.00	3510784087229	28,36
12	8	65	30	2+1	408.712.30	3510784087236	31,06
12	8	110	40	2+1	408.712.40EL	3510785401819	44,75
13	8	55	20	2+1	408.713.00	3510784087243	28,36
14	8	55	20	2+1	408.714.00	3510784087250	31,06
14	8	65	30	2+1	408.714.30	3510784087014	33,77
14	8	110	40	2+1	408.714.40EL	3510785401826	47,24
15	8	55	20	2+1	408.715.00	3510784087267	31,06
15	8	65	30	2+1	408.715.30	3510784087021	33,77
15	8	110	40	2+1	408.715.40EL	3510785401833	48,48
16	8	55	20	2+1	408.716.00	3510784087304	31,06
16	8	65	30	2+1	408.716.30	3510784087373	33,77
16	8	110	40	2+1	408.716.40EL	3510785401840	49,79
17	8	55	20	2+1	408.717.00	3510784087311	32,52
17	8	110	40	2+1	408.717.40EL	3661589089960	52,33
18	8	55	20	2+1	408.718.00	3510784087328	32,52
18	8	65	30	2+1	408.718.30	3510784087038	35,71
18	8	110	40	2+1	408.718.40EL	3510785401857	52,33
19	8	55	20	2+1	408.719.00	3510784087335	33,87
20	8	55	20	2+1	408.720.00	3510784087342	33,87
20	8	65	30	2+1	408.720.30	3510784087045	36,10
20	8	110	40	2+1	408.720.40EL	3510785401864	54,87
22	8	55	20	2+1	408.722.00	3510784087359	33,87
25	8	55	20	2+1	408.725.00	3510784087366	35,33

Mèches de diamètre < à 7 mm : carbure monobloc.

BOIS MASSIF

CLASSIC



HM

EN847-1

DEF.40.8

MÈCHE À RAINER DROITE

- 2 coupes latérales + coupe frontale.
- Assemblage rainure, languette et coupe plongeante dans le bois.



BOIS

Ø	Ø	L	LU	Z	REF	REF	€
6	8	70	15	2	408.706.70	3510784087427	33,87
8	8	70	15	2+1	408.708.70	3510784087441	33,87
10	8	70	15	2+1	408.710.70	3510784087465	38,04
12	8	70	15	2+1	408.712.70	3510784087519	39,50
14	8	70	15	2+1	408.714.70	3510784087533	39,50
15	8	70	15	2+1	408.715.70	3510784087540	39,50
16	8	70	15	2+1	408.716.70	3510784087557	39,50
18	8	70	15	2+1	408.718.70	3510784087618	40,90
20	8	70	15	2+1	408.720.70	3510784087625	40,90
22	8	70	15	2+1	408.722.70	3510784087632	40,90
24	8	70	15	2+1	408.724.70	3510784087649	46,32
25	8	70	15	2+1	408.725.70	3510784087656	49,25

BOIS MASSIF

CLASSIC

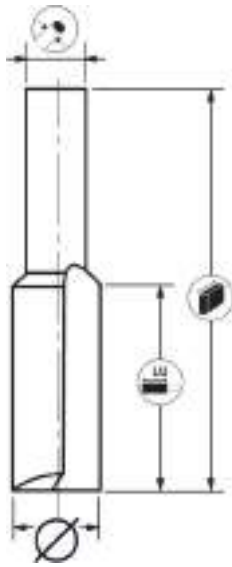

HM

EN847-1

DEF.40.1012

MÈCHE À RAINER DROITE

- 2 coupes latérales + coupe frontale.
- Assemblage rainure, languette et coupe plongeante dans le bois.

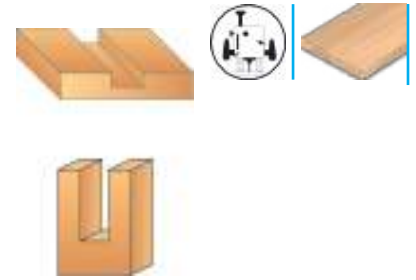

BOIS

∅	⊗	⊞	LU	Z	REF	⊞	€
8	10	60	20	2	410.708.00	3510784107149	56,17
10	10	70	25	2+1	410.710.00	3510784107156	63,15
12	10	70	25	2+1	410.712.00	3510784107187	66,01
14	10	70	25	2+1	410.714.00	3510784107217	71,53
15	10	70	25	2+1	410.715.00	3510784107231	71,53
16	10	70	25	2+1	410.716.00	3510784107255	72,89
20	10	70	25	2+1	410.720.00	3510784107316	82,41
20	10	87	35	2+1	410.720.35	3510784107323	98,10
22	10	87	35	2+1	410.722.35	3510784107347	91,00
25	10	70	25	2+1	410.725.00	3510784107361	95,23
30	10	70	25	2+1	410.730.00	3510784107378	110,54
8	12	55	25	2	412.708.00	3510784127109	56,17
10	12	55	25	2+1	412.710.00	3510784127123	60,45
10	12	110	50	2+1	412.710.50EL	3510785401895	86,47
12	12	55	25	2+1	412.712.00	3510784127130	66,01
12	12	70	40	2+1	412.712.40	3510784127147	78,35
12	12	110	50	2+1	412.712.50EL	3510785401901	86,47
14	12	55	25	2+1	412.714.00	3510784127154	71,53
14	12	70	40	2+1	412.714.40	3510784127161	81,06
14	12	110	50	2+1	412.714.50EL	3510785401918	89,02
15	12	70	40	2+1	412.715.00	3510784127178	79,70
15	12	110	50	2+1	412.715.50EL	3510785401987	89,02
16	12	70	40	2+1	412.716.00	3510784127208	82,41
16	12	110	50	2+1	412.716.50EL	3510785401925	90,25
18	12	70	40	2+1	412.718.00	3510784127215	87,87
18	12	110	50	2+1	412.718.50EL	3510785401932	96,58
20	12	70	40	2+1	412.720.00	3510784127222	90,58
20	12	110	50	2+1	412.720.50EL	3510785401949	99,13
22	12	70	40	2+1	412.722.00	3510784127239	93,34
25	12	70	40	2+1	412.725.00	3510784127253	110,54
30	12	70	40	2+1	412.730.00	3510784127260	135,55
35	12	70	40	2+1	412.735.00	3510784127277	142,51

BOIS MASSIF

CLASSIC

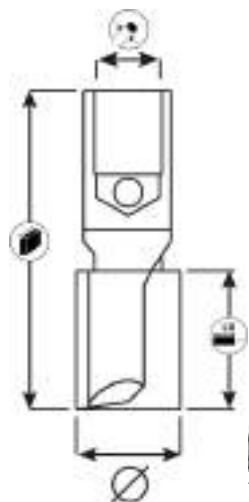

DEF.41.SCH MÈCHE À RAINUR DROITE



- 2 coupes latérales + coupe frontale.
- Assemblage rainure, languette et coupe plongeante dans le bois.
- Filetage intérieur M10.

BOIS

HM

EN847-1

Ø	Icon	Icon	Icon	Icon	REF	Icon	€
8	SCHEER	60	25	2	413.708.00	3510784137122	63,25
10	SCHEER	60	25	2+1	413.710.00	3510784137139	67,42
12	SCHEER	60	25	2+1	413.712.00	3510784137153	70,07
12	SCHEER	75	40	2+1	413.712.40	3510784137160	83,76
14	SCHEER	60	25	2+1	413.714.00	3510784137177	75,59
15	SCHEER	60	25	2+1	413.715.00	3510784137214	75,59
15	SCHEER	75	40	2+1	413.715.40	3510784137221	91,98
16	SCHEER	60	25	2+1	413.716.00	3510784137238	78,35
16	SCHEER	75	40	2+1	413.716.40	3510785418732	91,98
18	SCHEER	60	25	2+1	413.718.00	3510784137269	81,06
18	SCHEER	75	40	2+1	413.718.40	3510785418831	97,40
20	SCHEER	60	25	2+1	413.720.00	3510784137306	83,76
20	SCHEER	75	40	2+1	413.720.40	3510785418718	101,57
22	SCHEER	60	25	2+1	413.722.00	3510784137320	86,53
25	SCHEER	60	25	2+1	413.725.00	3510784137351	91,98
30	SCHEER	60	25	2+1	413.730.00	3510784137368	102,91

BOIS MASSIF

CLASSIC

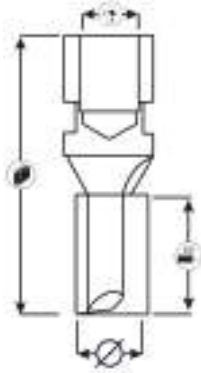

DEF.41.ELU

MÈCHE À RAINER DROITE

- 2 coupes latérales + coupe frontale.
- Assemblage rainure, languette et coupe plongeante dans le bois.
- Filetage intérieur M12.



BOIS

HM

EN847-1

Ø	ELU	70	35	Z	REF	3510784147121	€
10	ELU	70	35	2+1	414.710.35	3510784147121	70,07
12	ELU	75	40	2+1	414.712.40	3510785418862	72,83
15	ELU	75	40	2+1	414.715.40	3510785418909	76,94
16	ELU	75	40	2+1	414.716.40	3510784147244	81,06
18	ELU	75	40	2+1	414.718.40	3510784147275	81,06
20	ELU	75	40	2+1	414.720.40	3510784147312	83,76
25	ELU	60	25	2+1	414.725.00	3510784147343	94,70
30	ELU	60	25	2+1	414.730.00	3510784147350	104,26
35	ELU	60	25	2+1	414.735.00	3510784147374	117,90

BOIS MASSIF

CLASSIC

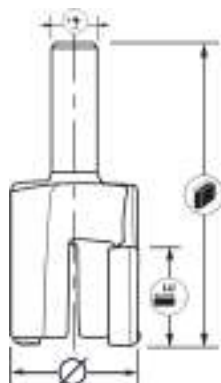

DEF.402.68

MÈCHE À ENTAILLER DROITE

- Réalisation d'entaille pour positionner charnières, paumelles, etc...



BOIS

HM

EN847-1

Ø				Z	REF		€
12	6	38	12	2	4026.712.00	3661589051004	19,48
13	6	38	12	2	4026.713.00	3661589050991	20,79
14	6	38	12	2	4026.714.00	3661589050984	22,20
15	6	38	12	2	4026.715.00	3661589050977	23,70
16	6	38	12	2	4026.716.00	3661589050960	23,70
18	6	38	12	2	4026.718.00	3661589050953	26,13
20	6	38	12	2	4026.720.00	3661589050946	27,92
22	6	38	12	2	4026.722.00	3661589050939	29,27
25	6	38	12	2	4026.725.00	3661589050922	31,28
12	8	38	12	2	4028.712.00	3661589050830	19,48
13	8	38	12	2	4028.713.00	3661589050847	20,79
14	8	38	12	2	4028.714.00	3661589050854	22,20
15	8	38	12	2	4028.715.00	3661589050861	23,70
16	8	38	12	2	4028.716.00	3661589050878	23,70
18	8	38	12	2	4028.718.00	3661589050885	26,13
20	8	38	12	2	4028.720.00	3661589050892	27,92
22	8	38	12	2	4028.722.00	3661589050908	29,27
25	8	38	12	2	4028.725.00	3661589050915	31,28

BOIS MASSIF

CLASSIC

DEF.470.8 DISQUE À RAINER

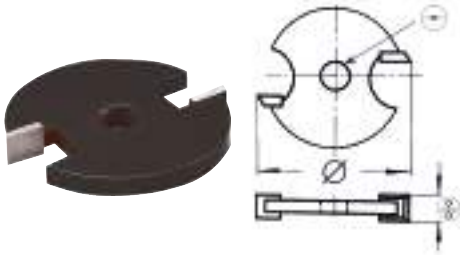

- Disque 2 coupes adaptable sur arbre porte-disque.

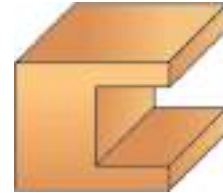

BOIS

HM

EN847-1

Ø	Ø	Ø	Z	REF		€
48	8	1,5	2	4708.715.00	3510784708025	24,08
48	8	2	2	4708.720.00	3510784708049	24,08
48	8	2,5	2	4708.725.00	3510784708063	24,08
48	8	3	2	4708.730.00	3510784708087	24,08
48	8	3,5	2	4708.735.00	3510781708097	24,08
48	8	4	2	4708.740.00	3510784708100	24,08
48	8	5	2	4708.750.00	3510784708117	24,08
48	8	6	2	4708.760.00	3510784708124	24,08

CLASSIC

DEF.ADP ARBRE PORTE-DISQUE



- Pour adaptation des disques à rainer cat. 4708, en alésage de 8 mm.

EN847-1

Ø	Ø	REF		€
22	6	4726.700.00	3510784726715	21,32
22	8	4728.700.00	3510784728719	21,32

RECHANGE : ROULEMENT 890.002.09

BOIS MASSIF

CLASSIC



DEF.400.8

MÈCHE À FEUILLURER + GUIDE



- Feuillurage dans le bois en suivant un gabarit.

HM

EN847-1

BOIS

Ø	Ø	LU	Z	REF	REF	€
32	8	13	2	4008.732.00	3510784008712	39,50
35	8	13	2	4008.735.00	3510784008729	40,90

RECHANGE : ROULEMENT (Ø32) 890.002.06 - ROULEMENT (Ø 35) 890.002.08

CLASSIC



DEF.4398

MÈCHE D'ASSEMBLAGE + GUIDE



- Assemblage à dentures multiples avec large surface de collage dans le bois en suivant un gabarit.



HM

EN847-1

BOIS

Ø	Ø	LU	Ø	Z	REF	REF	€
35	8	38	8	2	4398.700.00	3510784398714	86,53

RECHANGE : ROULEMENT 890.002.04

BOIS MASSIF

CLASSIC



DEF.432.8 MÈCHE D'ASSEMBLAGE POUR TIROIRS

- Assemblage pour tiroirs dans le bois.

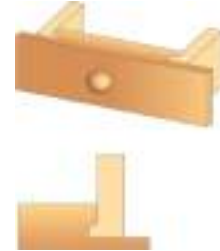
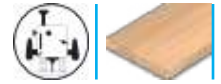

BOIS

HM

EN847-1

Ø	Ø	LU	Z	REF	REF	€
32	8	13	2	4328.700.00	3510784328711	44,97

CLASSIC



DEF.4358.8 MÈCHE BOUVETAGE À PLAT

- Symétrique, pour bouvetage à plat par retournement.



BOIS

HM

EN847-1

Ø	Ø	LU	Z	REF	REF	€
44	8	14 - 32	2	4358.700.00	3510784358824	66,01

CLASSIC



DEF.4368 MÈCHE BOUVETAGE À 45°

- Assemblage pour bouvetage à 45° dans le bois.



BOIS

HM

EN847-1

Ø	Ø	LU	Z	REF	REF	€
51	8	14 - 22	2	4368.700.01	3510784368731	103,61

BOIS MASSIF

CLASSIC

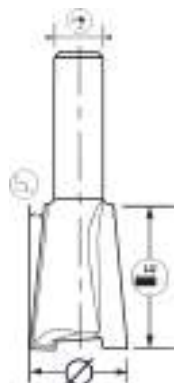

DEF.426.8

MÈCHE D'ASSEMBLAGE À QUEUE D'ARONDE

- Assemblage en queue d'aronde dans le bois.



HM

EN847-1

Ø	Ø	LU	Z	°	REF		€
10	8	10	2	9°	4268.710.00	3510784268741	33,28
14	8	14	2	14°	4268.714.00	3510784268727	33,28
16	8	22	2	7°	4268.716.00	3510784268734	33,28
19	8	22	2	7°	4268.719.00	3510784268758	33,28

BOIS

CLASSIC

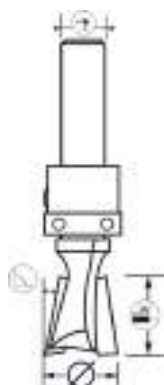

DEF.436A.8

MÈCHE D'ASSEMBLAGE À QUEUE D'ARONDE + GUIDE SUPÉRIEUR

- Assemblage en queue d'aronde dans le bois en suivant un gabarit.



HM

EN847-1

Ø	Ø	LU	Z	°	REF		€
12,7	8	12,7	2	8°	4368.713.00	3510784368724	37,34
14	8	12,7	2	14°	4368.714.00	3661589042682	37,34

BOIS

RECHANGE : ROULEMENT (Ø 12,7) 890.002.10 - ROULEMENT (Ø 14) 890.002.13

BOIS MASSIF

CLASSIC

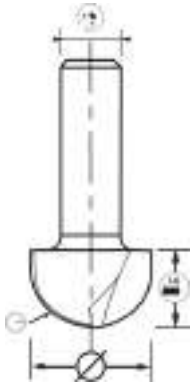

DEF.420.68
MÈCHE À GORGE

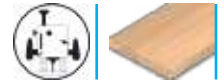

- Profilage en gorge dans le bois.



BOIS

HM

EN847-1

∅			Z		REF		€
6	6	13	2	3,00	4206.703.00	3510784206712	29,70
10	6	7	2	5,00	4206.705.00	3510784206736	29,70
12	6	10	2	6,00	4206.706.00	3510784206743	33,87
16	6	10	2	8,00	4206.708.00	3510784206750	35,33
20	6	12	2	10,00	4206.710.00	3510784206767	36,69
3,2	8	10	2	1,60	4208.716.00	3510784208778	29,70
6	8	13	2	3,00	4208.703.00	3510784208716	29,70
10	8	7	2	5,00	4208.705.00	3510784208730	29,70
12	8	10	2	6,00	4208.706.00	3510784208747	33,87
16	8	10	2	8,00	4208.708.00	3510784208754	35,33
20	8	12	2	10,00	4208.710.00	3510784208761	36,69

CLASSIC

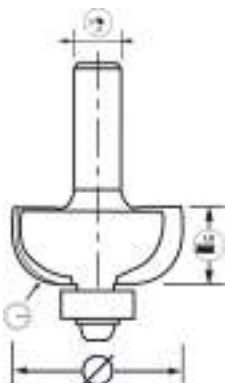

DEF.422.8
MÈCHE À GORGE + GUIDE



- Profilage en demi-gorge dans le bois en suivant un gabarit.



BOIS

HM

EN847-1

∅			Z		REF		€
22	8	11	2	5,00	4228.705.00	3510784228714	35,33
25	8	13	2	6,00	4228.706.00	3510784228752	36,69
29	8	14	2	8,00	4228.708.00	3510784228721	38,04
32	8	18	2	10,00	4228.710.00	3510784228738	40,90
38	8	19	2	12,00	4228.712.00	3510784228745	49,25

RECHANGE : ROULEMENT 890.002.08

BOIS MASSIF

CLASSIC



DEF.425.68

MÈCHE 1/4 DE ROND + GUIDE

- Défonçage en quart de rond avec ou sans plats sur le dessus, dans le bois en suivant un gabarit.



HM

EN847-1

BOIS

Ø			Z		REF		€
16	6	13	2	1,60	4256.702.00	3510785418855	38,04
19	6	13	2	3,00	4256.703.00	3510784256793	38,04
22	6	13	2	5,00	4256.705.00	3510784256724	42,26
26	6	13	2	6,00	4256.706.00	3510784256731	42,26
29	6	13	2	8,00	4256.708.00	3510784256748	43,62
32	6	14	2	10,00	4256.710.00	3510784256755	47,89
38	6	19	2	12,00	4256.712.00	3510784256762	49,25
16	8	13	2	1,60	4258.702.00	3510784258780	38,04
19	8	13	2	3,00	4258.703.00	3510784258797	38,04
22	8	13	2	5,00	4258.705.00	3510784258728	42,26
26	8	13	2	6,00	4258.706.00	3510784258735	42,26
29	8	13	2	8,00	4258.708.00	3510784258742	43,62
32	8	14	2	10,00	4258.710.00	3510784258759	47,89
38	8	19	2	12,00	4258.712.00	3510784258766	49,25
44	8	16	2	16,00	4258.716.00	3510784258803	67,42
53	8	25	2	20,00	4258.720.00	3510784258810	72,89

RECHANGE : ROULEMENT (Ø 12,7) 890.002.08 - ROULEMENT (Ø 9,5) 890.002.06

BOIS MASSIF

CLASSIC

DEF.424.8

MÈCHE 1/4 DE ROND + GUIDE

- Défonçage en quart de rond avec ou sans plats aux extrémités dans le bois.



BOIS

HM

EN847-1

Ø	⌀	LU	Z	⌀	REF	⌀	€
17	8	12	2	4,00	4248.704.00	3510784248729	32,52
19	8	12	2	5,00	4248.705.00	3510784248736	35,33
21	8	12	2	6,00	4248.706.00	3510784248743	36,69
25	8	13	2	8,00	4248.708.00	3510784248750	38,04
29	8	14	2	10,00	4248.710.00	3510784248767	39,39
31	8	19	2	12,00	4248.712.00	3510784248774	51,95
37	8	22	2	15,00	4248.715.00	3510784248781	64,66

CLASSIC

DEF.435.8

MÈCHE 1/4 DE ROND AVEC PLAT + GUIDE

- Défonçage en quart de rond avec ou sans plats aux extrémités, avec guide à billes, dans le bois.



BOIS

HM

EN847-1

Ø	⌀	LU	Z	⌀	REF	⌀	€
22	8	13	2	5,00	4358.705.00	3510784358725	46,53
26	8	13	2	6,00	4358.706.00	3510785418787	46,53
29	8	13	2	8,00	4358.708.00	3510784358749	47,89
32	8	14	2	10,00	4358.710.00	3510784358756	51,24
38	8	19	2	12,00	4358.712.00	3510784358763	53,46
44	8	16	2	16,00	4358.716.00	3510784358800	72,89
53	8	25	2	20,00	4358.720.00	3510784358817	79,70

BOIS MASSIF

CLASSIC



DEF.441.8
MÈCHE 1/2 ROND

- Défonçage en demi-rond avec ou sans plats aux extrémités, dans le bois.



BOIS

HM

EN847-1

Ø	Ø	LU	Z	Ø	REF	Ø	€
22	8	15	2	3,00	4418.703.00	3510785418893	39,50
26	8	19	2	5,00	4418.705.00	3510784418726	44,59
28	8	21	2	6,00	4418.706.00	3510784418733	46,32

CLASSIC



DEF.443.8
MÈCHE POUR MOULURES DÉCORATIVES

- Moulure décorative dans le bois.



BOIS

HM

EN847-1

Ø	Ø	LU	Z	Ø	Ø	REF	Ø	€
19	8	13	2	4,00	4,00	4438.704.00	3510784438717	36,69

CLASSIC



DEF.453.8
MÈCHE POUR MOULURES DÉCORATIVES + GUIDE SUPÉRIEUR

- Moulure décorative dans le bois en suivant un gabarit.



BOIS

HM

EN847-1

Ø	Ø	LU	Z	Ø	Ø	REF	Ø	€
22	8	13	2	4,80	4,80	4538.705.00	3510784538714	44,22

RECHANGE : ROULEMENT 890.002.09

BOIS MASSIF

CLASSIC



DEF.460.8 MÈCHE POUR MOULURES DÉCORATIVES + GUIDE

- Moulure décorative dans le bois en suivant un gabarit.



BOIS

HM

EN847-1

Ø	Ø	LU	Z	Ø	REF	REF	€
29	8	13	2	4,00	4608.704.00	3510784608721	51,95

RECHANGE : ROULEMENT 890.002.08

CLASSIC



DEF.447.8 MÈCHE POUR MOULURES DÉCORATIVES + GUIDE

- Moulure décorative dans le bois en suivant un gabarit.



BOIS

HM

EN847-1

Ø	Ø	LU	Z	Ø	REF	REF	€
29	8	12	2	4,00	4478.704.00	3510784478713	46,53
38	8	17	2	6,40	4478.706.00	3510784478737	56,17

RECHANGE : ROULEMENT 890.002.08

CLASSIC



DEF.433.8 MÈCHE POUR POIGNÉES

- Réalisation de poignées en agencement.



BOIS

HM

EN847-1

Ø	Ø	LU	Z	Ø	Ø	REF	REF	€
19	8	19	2	4,76	2,40	4338.719.00	3661589050748	44,37

BOIS MASSIF



DEF.448.8

MÈCHE POUR MOULURES DÉCORATIVES + GUIDE

- Moulure décorative dans le bois en suivant un gabarit.



HM

EN847-1

Ø	Ø	LU	Z	Ø	Ø	REF	REF	€
29	8	13	2	4,00	4,00	4488.704.00	3510784488712	46,53
35	8	19	2	6,40	4,80	4488.706.00	3510784488729	56,17

RECHANGE : ROULEMENT 890.002.08



DEF.449.8

MÈCHE POUR MOULURES DÉCORATIVES + GUIDE

- Moulure décorative dans le bois en suivant un gabarit.



HM

EN847-1

Ø	Ø	LU	Z	Ø	REF	REF	€
33	8	13	2	4,00	4498.704.00	3510784498711	51,95
43	8	19	2	6,40	4498.706.00	3510784498728	56,17

RECHANGE : ROULEMENT 890.002.08



DEF.437.8

MÈCHE POUR MOULURES DÉCORATIVES + GUIDE

- Moulure décorative dans le bois en suivant un gabarit.



HM

EN847-1

Ø	Ø	LU	Z	REF	REF	€
27	8	40	2	4378.700.00	3510784378716	79,70

RECHANGE : ROULEMENT 890.002.08

BOIS MASSIF

CLASSIC

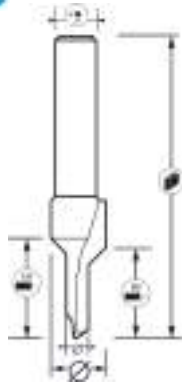

DEF.438A45.8

MÈCHE À RAINER POUR VIS

- Réalisation de rainures à 45° pouvant fixer, noyer les têtes de vis et laisser coulisser 2 parties.



BOIS

HM

EN847-1

						REF		€
11,1-4,36	8	58	27 + 14	2	45°	4388.700.00	3661589050755	48,71

CLASSIC

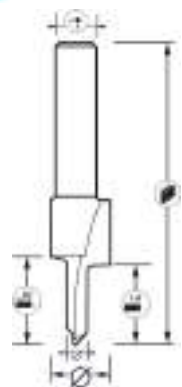

DEF.438A90.8

MÈCHE À RAINER POUR VIS

- Réalisation de rainures à 90° pouvant fixer, noyer les têtes de vis et laisser coulisser 2 parties.



BOIS

HM

EN847-1

						REF		€
12,7-4,36	8	60	29 + 16	2	90°	4388.700.01	3661589050762	48,71

CLASSIC



DEF.440.68

MÈCHE POUR OCCULUS

- Perçage et affleurage dans le bois en suivant un gabarit.



BOIS

HM

EN847-1

				REF		€
6	6	20	2	4406.706.00	3510784406716	21,32
6	8	20	2	4408.706.00	3510784408710	21,32

BOIS MASSIF

CLASSIC



HSS

EN847-1

DEF.431.68

MÈCHE À POINTE LASER

- Défonçage en «V» à 60° et réalisation d'ornements dans le bois.



BOIS

Ø	Flutes	LU	Z	Angle	REF	Code	€
15	6	13	3	60°	4316.700.00	3510785418879	36,69
15	8	13	3	60°	4318.700.00	3510784318712	36,69

CLASSIC



HM

EN847-1

DEF.429.68

MÈCHE À RAINURE EN «V»

- Défonçage en «V» à 90° et réalisation d'ornements dans le bois.



BOIS

Ø	Flutes	LU	Z	Angle	REF	Code	€
10	6	13	2	90°	4296.710.00	3510785418817	28,36
14	6	13	2	90°	4296.714.00	3510784296713	29,70
10	8	13	2	90°	4298.710.00	3510785418763	28,36
14	8	13	2	90°	4298.714.00	3510784298717	29,70
16	8	13	2	90°	4298.716.00	3510784298748	39,50

CLASSIC



HM

EN847-1

DEF.430.8

MÈCHE POUR TASSES ET ASSIETTES

- Défonçage en creux arrondi dans le bois.



BOIS

Ø	Flutes	LU	Z	Angle	REF	Code	€
19	8	16	2	6,40	4308.719.00	3510784308713	43,62
32	8	16	2	6,40	4308.732.00	3510784308720	49,25

BOIS MASSIF

CLASSIC



DEF.36.12 MÈCHE POUR MOULURES DÉCORATIVES + GUIDE

- Moulure décorative dans le bois en suivant un gabarit.

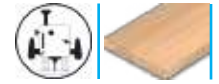

HM

EN847-1

							BOIS	
Ø	Ø	LU	Z	REF		€		
64	12	20	2	3612.700.00	3510783612712	106,32		

RECHANGE : ROULEMENT 890.002.08

CLASSIC



DEF.37.12 MÈCHE À PLATE-BANDE + GUIDE

- Profilage en forme de plate-bande dans le bois en suivant un gabarit.

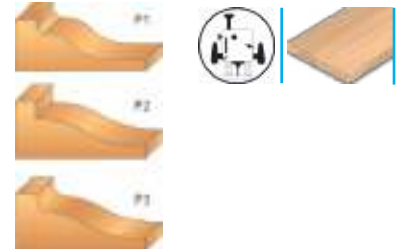

HM

EN847-1

							BOIS	
	Ø	Ø	LU	Z	REF		€	
N°1	76	12	16	2	3712.700.01	3510783712719	107,68	
N°2	76	12	16	2	3712.700.02	3510785418794	107,68	
N°3	76	12	16	2	3712.700.03	3510783712733	107,68	

RECHANGE : ROULEMENT 890.002.08

CLASSIC



DEF.380.8 MÈCHE À PLATE-BANDE + GUIDE

- Profilage en forme de plate-bande dans le bois en suivant un gabarit.



HM

EN847-1

							BOIS	
Ø	Ø	LU	Z			REF	€	
51	8	12,7	2	9,50	9,50	3808.700.00	3510785418701	106,32

RECHANGE : ROULEMENT 890.002.08

BOIS MASSIF

CLASSIC



DEF.439.812

JEU DE 2 MÈCHES D'ASSEMBLAGE + GUIDE

- Assemblage par profil / contre-profil avec large surface de collage dans le bois en suivant un gabarit.

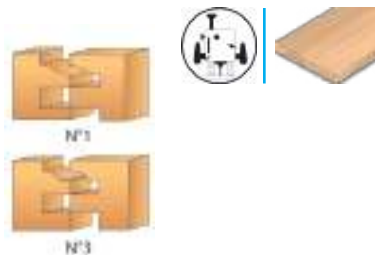

HM

EN847-1

	Ø	Ø	LU	Z	REF		€
N°1	41	8	25	2	4398.700.01	3510784398707	127,47
N°1	41	12	25	2	4392.700.01	3510784392712	127,47
N°3	41	8	25	2	4398.700.03	3510784398738	127,47

RECHANGE : ROULEMENT 890.002.09

EXPERT

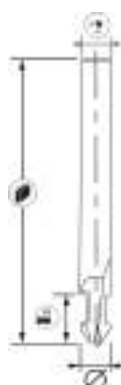

DEF.553.6

FRAISE POUR JOINT ANCRE

- Fraise carbure monobloc.
- Rainurage des portes et fenêtres pour le positionnement des joints.
- Forme ancre simple ou double.

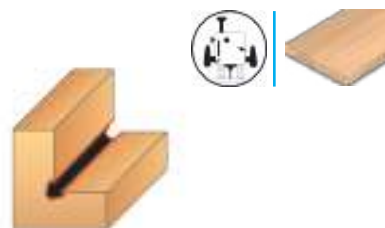

HM

EN847-1

	Ø	Ø	LU	Z	REF		€
SIMPLE	5,5	6	60	10	5536.705.00	3661589052605	54,01
DOUBLE	5,5	6	70	10	5536.705.02	3661589052612	75,64

EXPERT



DEF.554.6

FRAISE POUR JOINT DROIT

- Fraise carbure monobloc.
- Rainurage des portes et fenêtres pour le positionnement des joints.
- Forme droite simple ou double.

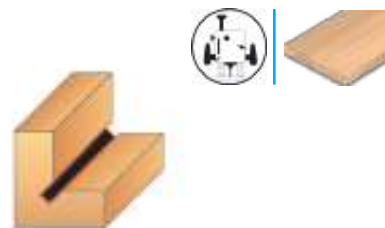

HM

EN847-1

	Ø	Ø	LU	Z	REF		€
SIMPLE	3	6	60	10	5546.703.00	3661589052629	46,76
DOUBLE	3	6	70	10	5546.703.02	3661589053176	78,24

BOIS MASSIF

CLASSIC



DEF.434.8

MÈCHE POUR RAINURE EN T



- Rainurage dit «trou de serrure» pour suspension invisible de mobilier léger.



HM

EN847-1

BOIS

Ø	LU	Z	REF	€		
5 - 10	8	5+5	1	4348.700.00	3510784348719	28,36

EXPERT



DEF.4280.M12

MÈCHE QUEUE D'ARONDE 15° À PLAQUETTE



- Usinage queue d'aronde 15° pour assemblage de charpente.

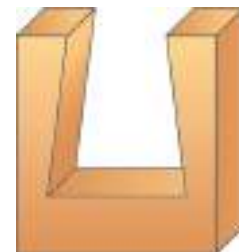

HM

PLAQUETTES

EN847-1

BOIS

Ø	LU	Z	REF	€			
39,5	31,5	2	15°	4280.4931.00	3510785424719	259,71	
PLAQUETTE	31,5	9	1,5	2	4280.3592.4	3510785424702	12,99

BOIS MASSIF

CLASSIC



DEF.4728.05

COFFRET DE 5 DISQUES À RAINER



Épaisseur disques : 2,5 / 3 / 4 / 5 / 6 mm
 Arbres : Lt.72-Lu.26 mm / Lt.65-Lu.20 mm
 Roulements : Ø19 / Ø22 mm
 Bagues : 2x0,5 mm / 4x1 mm / 4x2 mm

HM

EN847-1

BOIS



REF



€

48

8

4728.700.52

3661589095206

69,64

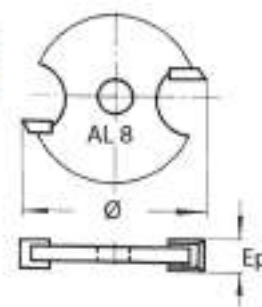

CLASSIC



DEF.428.10

COFFRET DE 10 MÈCHES À RAINER DROITES



Ø 6 / 8 / 10 / 12 / 14 / 15 / 16 / 18 / 20 / 25 mm

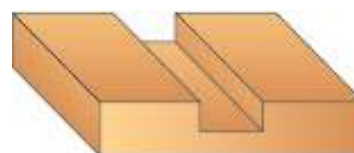

HM

EN847-1

BOIS



REF



€

8

428.700.10

3510784287100

50,59

BOIS MASSIF



DEF.428.20
COFFRET DE 20 MÈCHES DE DÉFONCEUSE



BOIS

	REF		€
8	428.700.20	3510784287209	95,72

HM

EN847-1



- 1 mèche à gorge 3,2 mm
- 2 mèche à gorge 6 mm
- 3 mèche à rainurer en V 12,7 mm
- 4 mèche à affleurer 30°
- 5 mèche queue d'aronde 14°
- 6 mèche pour occulus 6 mm
- 7 mèche à affleurer 12,7 mm
- 8 mèche droite 8 mm*
- 9 mèche droite 10 mm*
- 10 mèche droite 12 mm*
- 11 mèche droite 16 mm*
- 12 mèche droite 20 mm*
- 13 mèche à gorge 5 mm
- 14 mèche à affleurer 9,5 mm
- 15 mèche à gorge R=6
- 16 mèche 1/4 de rond R=6
- 17 mèche 1/4 de rond 2 plats R=6
- 18 mèche à affleurer 45°
- 19 mèche pour moulure R=4
- 20 mèche à feuillurer 28,6 mm



DEF.428.30
COFFRET DE 30 MÈCHES DE DÉFONCEUSE



BOIS

	REF		€
8	428.700.30	3510784287308	133,96

HM

EN847-1

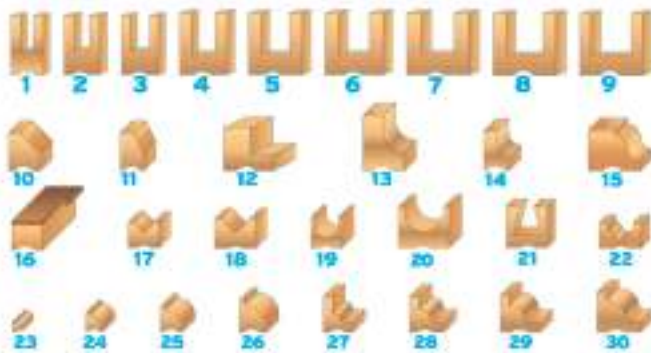

- 1 mèche droite 6 mm*
- 2 mèche droite 8 mm*
- 3 mèche droite 10 mm*
- 4 mèche droite 12 mm*
- 5 mèche droite 14 mm*
- 6 mèche droite 15 mm*
- 7 mèche droite 16 mm*
- 8 mèche droite 18 mm*
- 9 mèche droite 20 mm*
- 10 mèche à affleurer 45°
- 11 mèche à affleurer 25°
- 12 mèche à feuillurer Ø 28,6
- 13 mèche à gorge R=10
- 14 mèche à gorge R=6
- 15 mèche pour moulure R=4
- 16 mèche à affleurer 12,7 mm
- 17 mèche à rainurer en V 10 mm
- 18 mèche à rainurer en V 12,7 mm
- 19 mèche à gorge R= 3,2 mm
- 20 mèche à gorge R= 6 mm
- 21 mèche queue d'aronde 12,7 mm
- 22 mèche pour moulure R=2,4
- 23 mèche 1/4 de rond R=3
- 24 mèche 1/4 de rond R=6
- 25 mèche 1/4 de rond R=8
- 26 mèche 1/4 de rond R=10
- 27 mèche 1/4 de rond 2 plat R=3
- 28 mèche 1/4 de rond 2 plat R=6
- 29 mèche 1/4 de rond 2 plat R=8
- 30 mèche 1/4 de rond 2 plat R=10

BOIS MASSIF



HM

EN847-1

DEF.428.66
COFFRET DE 66 MÈCHES DE DÉFONCEUSE



BOIS

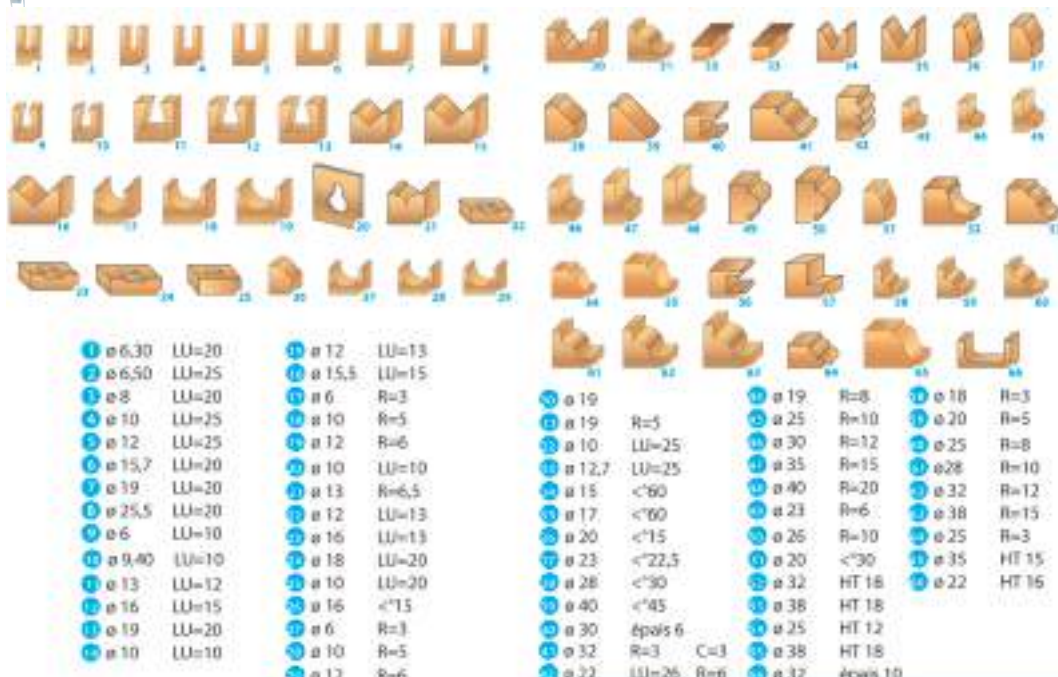

HM

EN847-1

DEF.428.14
COFFRET DE 12+2 MÈCHES DE DÉFONCEUSE



BOIS

Mèche à gorge R=6
Mèche à gorge avec guide R=4
Mèche queue d'aronde ø 12,7
Mèche d'affleureuse à chanfreiner 45°
Mèche d'affleureuse droite ø 12
Mèche droite 16 mm
Mèche 1/4 de rond R=6

Mèche droite 8 mm
Mèche droite 12 mm
Mèche 1/4 de rond R=10
Mèche à rainure en v 14-90°
Mèche pour moule R=4
Mèche droite 10 mm
Mèche droite 20 mm



REF



€

8

428.700.14

3661589082244

68,29

PANNEAUX ET DÉRIVÉS DU BOIS

CLASSIC

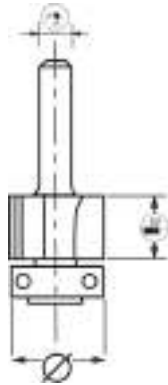

HM

EN847-1

DEF.467.68

MÈCHE D'AFFLEUREUSE DROITE + GUIDE

- Affleurage des chants dans le bois et panneaux mélaminés et stratifiés, en suivant un gabarit.



BOIS, MÉLAMINÉ, STRATIFIÉ

Ø	Ø	LU	Z	REF		€
19	6	16	2	4676.700.00	3510784676713	29,70
19	6	30	2	4676.700.30	3510784676720	56,17
19	8	16	2	4678.700.00	3510784678717	29,70
19	8	30	2	4678.700.30	3510784678724	56,17

RECHANGE : ROULEMENT 890.002.04

CLASSIC

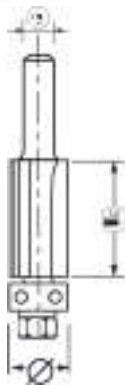

HM

EN847-1

DEF.467S.68

MÈCHE D'AFFLEUREUSE DROITE + GUIDE

- Affleurage des chants dans le bois et panneaux mélaminés et stratifiés, en suivant un gabarit.



BOIS, MÉLAMINÉ, STRATIFIÉ

Ø	Ø	LU	Z	REF		€
9,5	6	25	2	4676.709.00	3510785418688	31,06
12,7	6	25	2	4676.713.00	3510784676744	32,52
9,5	8	25	2	4678.709.00	3510784678731	31,06
12,7	8	25	2	4678.713.00	3510784678748	32,52

RECHANGE : ROULEMENT (Ø 9,5) 890.002.06 - ROULEMENT (Ø 12,7) 890.002.08

CLASSIC

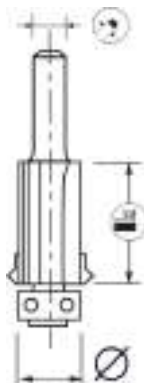

HM

EN847-1

DEF.467V.8

MÈCHE D'AFFLEUREUSE AVEC JOINT EN «V» + GUIDE

- Affleurage des chants avec rainure en «V» dans le bois en suivant un gabarit.



BOIS, MÉLAMINÉ

Ø	Ø	LU	Z	REF		€
12,7	8	26	2	4678.713.01	3510784678755	40,10

RECHANGE : ROULEMENT 890.002.08

PANNEAUX ET DÉRIVÉS DU BOIS

CLASSIC

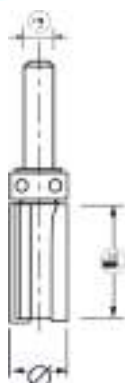

HM

EN847-1

DEF.461.8

MÈCHE D'AFFLEUREUSE DROITE + GUIDE SUPÉRIEUR

- Dressage des chants dans le bois en suivant un gabarit.



BOIS, MÉLAMINÉ

Ø	Ø	LU	Z	REF	REF	€
12,7	8	25	2	4618.713.00	3510784618744	32,52

RECHANGE : ROULEMENT 890.002.10

CLASSIC

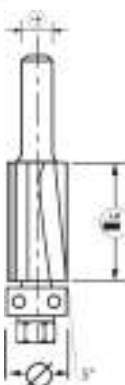

HM

EN847-1

DEF.462.8

MÈCHE D'AFFLEUREUSE BIAISÉE NÉGATIVE + GUIDE

- Affleurage des chants dans le bois.
- Recommandée pour les panneaux mélaminés et stratifiés, en suivant un gabarit.
- Coupe biaisée et négative pour meilleure finition.



BOIS, MÉLAMINÉ

Ø	Ø	LU	Z	REF	REF	€
19	8	25,4	2	4628.719.00	3510785435456	47,40

RECHANGE : ROULEMENT 890.002.04

CLASSIC

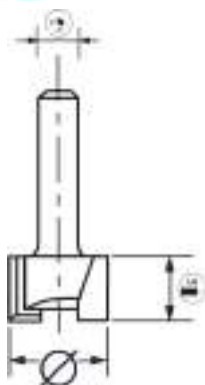

HM

EN847-1

DEF.464.68

MÈCHE D'AFFLEUREUSE DROITE

- Dressage des chants dans le bois.



BOIS, MÉLAMINÉ

Ø	Ø	LU	Z	REF	REF	€
19	6	16	2	4646.700.00	3510784646716	28,36
19	8	16	2	4648.700.00	3510784648710	28,36

PANNEAUX ET DÉRIVÉS DU BOIS

CLASSIC

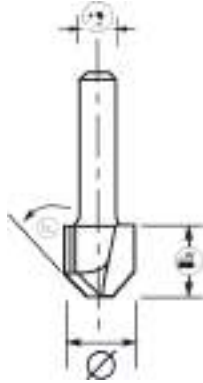

DEF.465.68

MÈCHE D'AFFLEUREUSE COMBINÉE

- Affleurement et chanfreinage des chants.



BOIS, MÉLAMINÉ

HM

EN847-1

Ø	Ø ₁	LU	Z	α	REF	GT	€
12	6	13	2	22°	4656.722.00	3510784656715	26,95
12	6	13	2	30°	4656.730.00	3510784656722	26,95
12	6	13	2	45°	4656.745.00	3510784656739	26,95
12	8	13	2	22°	4658.722.00	3510784658719	26,95
12	8	13	2	30°	4658.730.00	3510784658726	26,95
12	8	13	2	45°	4658.745.00	3510784658733	26,95

CLASSIC

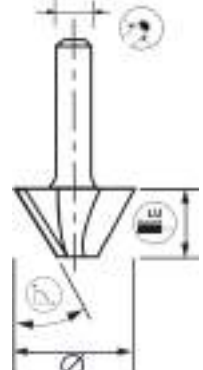

DEF.466.68

MÈCHE À CHANFREINER

- Chanfreinage des chants dans les bois durs, les panneaux mélaminés et stratifiés.



BOIS, MÉLAMINÉ

HM

EN847-1

Ø	Ø ₁	LU	Z	α	REF	GT	€
24	6	14	2	15°	4666.715.00	3510784666714	35,33
24	6	12	2	30°	4666.730.00	3510784666721	36,69
24	6	9	2	45°	4666.745.00	3510784666738	36,69
24	8	14	2	15°	4668.715.00	3510784668718	35,33
24	8	12	2	30°	4668.730.00	3510784668725	36,69
24	8	9	2	45°	4668.745.00	3510784668732	36,69

PANNEAUX ET DÉRIVÉS DU BOIS

CLASSIC

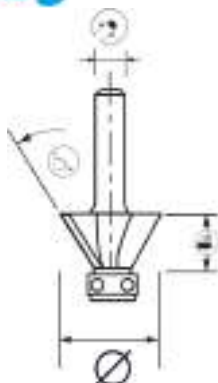

DEF.468.68

MÈCHE À CHANFREINER + GUIDE

- Chanfreinage des chants dans les bois durs, les panneaux mélaminés et stratifiés, en suivant un gabarit.



BOIS, MÉLAMINÉ

HM

EN847-1

Ø	Ø	LU	Z	Angle	REF	Code	€
19	6	13	2	15°	4686.719.00	3510785418770	32,52
22	6	13	2	25°	4686.722.00	3510785418848	35,33
32	6	12	2	45°	4686.732.00	3510785418725	36,69
45	6	20	2	45°	4686.745.00	3510785418824	44,97
19	8	13	2	15°	4688.719.00	3510784688723	32,52
22	8	13	2	25°	4688.722.00	3510784688730	35,33
32	8	12	2	45°	4688.732.00	3510784688747	36,69
45	8	20	2	45°	4688.745.00	3510784688754	44,97

RECHANGE : ROULEMENT 890.002.08

CLASSIC

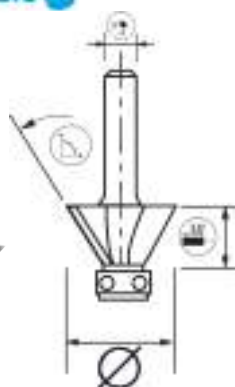

DEF.469.68

MÈCHE À CHANFREINER + GUIDE

- Chanfreinage des chants dans les bois durs, les panneaux mélaminés et stratifiés, en suivant un gabarit.



BOIS, MÉLAMINÉ

HM

EN847-1

Ø	Ø	LU	Z	Angle	REF	Code	€
26	6	8,5	2	30°	4696.730.00	3510784696728	35,33
27	6	5,5	2	45°	4696.745.00	3510784696735	35,33
26	8	8,5	2	30°	4698.730.00	3510784698722	35,33
27	8	5,5	2	45°	4698.745.00	3510784698739	35,33

RECHANGE : ROULEMENT 890.002.03

PANNEAUX ET DÉRIVÉS DU BOIS

EXPERT

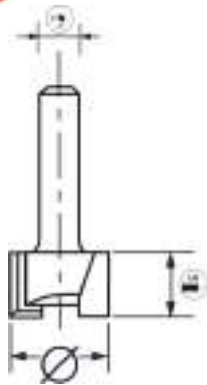

DEF.564.68

MÈCHE D'AFFLEUREUSE DROITE

- Dressage des chants dans le bois.



BOIS, MDF/HDF, MÉLAMINÉ

HM
MICROGRAIN

EN847-1

Ø	Ø	Ø	LU	Z	REF		€
19	6	51	19	2	5646.700.00	3661589052414	32,63
19	8	51	19	2	5648.700.00	3661589052452	32,63

EXPERT

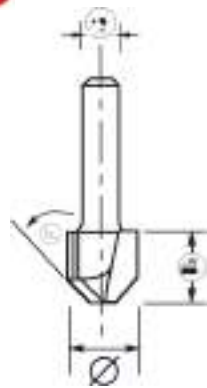

DEF.565.6

MÈCHE D'AFFLEUREUSE COMBINÉE

- Affleurage et chanfreinage des chants.



BOIS, MDF/HDF, MÉLAMINÉ

HM
MICROGRAIN

EN847-1

Ø	Ø	Ø	LU	Z	Angle	REF		€
12,7	6	41	12,7	2	23°	5656.723.00	3661589052421	31,01
12,7	6	41	12,7	2	30°	5656.730.00	3661589052438	31,01

EXPERT

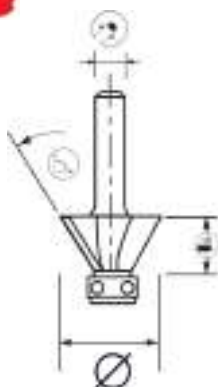

DEF.568.68

MÈCHE À CHANFREINER + GUIDE

- Chanfreinage des chants dans le bois durs, les panneaux mélaminés et stratifiés, en suivant un gabarit.

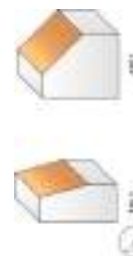

BOIS, MDF/HDF, MÉLAMINÉ, STRATIFIÉ

HM
MICROGRAIN

EN847-1

Ø	Ø	Ø	LU	Z	Angle	REF		€
20,3	6	49	10	3	15°	5686.715.00	3661589052650	37,39
31,4	6	60	10	3	45°	5686.745.00	3661589052667	42,21
20,3	8	53	10	3	15°	5688.715.00	3661589052568	37,39
31,4	8	63	10	3	45°	5688.745.00	3661589052575	42,21

RECHANGE : ROULEMENT 890.002.03

PANNEAUX ET DÉRIVÉS DU BOIS

EXPERT

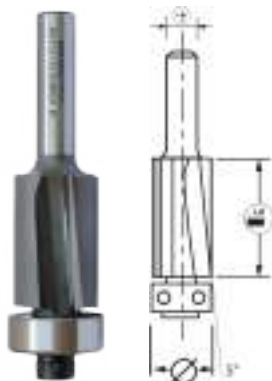

HM
MICROGRAIN

EN847-1

DEF.562.68

MÈCHE D'AFFLEUREUSE BIAISÉE + GUIDE

- Affleurage des chants dans le bois et panneaux mélaminés et stratifiés, en suivant un gabarit.
- Finition parfaite, liée à la coupe biale négative.

BOIS, MDF/HDF, MÉLAMINÉ, STRATIFIÉ

Ø	Ø	Ø	LU	Z	REF		€
19	6	61	16	2	5626.700.00	3661589052469	34,20
19	6	72	26	2	5626.700.25	3661589052476	64,61
19	8	64	16	2	5628.700.00	3661589052506	34,20
19	8	75	26	2	5628.700.25	3661589052513	64,61

EXPERT

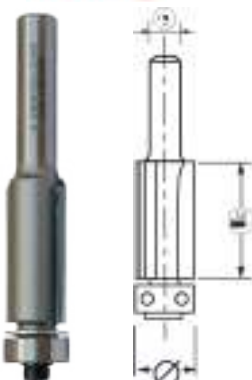

HM
MICROGRAIN

EN847-1

DEF.567.68

MÈCHE D'AFFLEUREUSE DROITE + GUIDE

- Affleurage des chants dans le bois et panneaux mélaminés et stratifiés, en suivant un gabarit.

BOIS, MDF/HDF, MÉLAMINÉ, STRATIFIÉ

Ø	Ø	Ø	LU	Z	REF		€
9,5	6	69	25,4	2	5676.709.00	3661589052643	35,71
12,7	6	67	25,4	2	5676.713.00	3661589052490	37,39
9,5	8	72	25,4	2	5678.709.00	3661589052520	35,71
12,7	8	71	25,4	2	5678.713.00	3661589052537	37,39

RECHANGE : ROULEMENT (Ø9,5) 890.002.06 - ROULEMENT (Ø12,7) 890.002.08

EXPERT



HM
MICROGRAIN

EN847-1

DEF.561.68

MÈCHE D'AFFLEUREUSE DROITE + GUIDE SUPÉRIEUR

- Dressage des chants dans le bois en suivant un gabarit.

BOIS, MDF/HDF, MÉLAMINÉ, STRATIFIÉ

Ø	Ø	Ø	LU	Z	REF		€
12,7	6	63	25,4	2	5616.713.00	3661589052674	37,39
12,7	8	65	25,4	2	5618.713.00	3661589052582	37,39

RECHANGE : ROULEMENT (AL6,35) 890.002.15 - ROULEMENT (AL8) 890.002.10

PANNEAUX ET DÉRIVÉS DU BOIS

EXPERT



DEF.81.68

MÈCHE D'AFFLEUREUSE À PLAQUETTES RÉVERSIBLES

- Affleurage, rainurage et coupe plongeante dans le bois.



BOIS, MÉLAMINÉ

Ø	Ø	Ø	Z	REF	REF	€
19	6	42	2	816.700.00	3510788167002	75,59
19	8	42	2	818.700.00	3510788187000	75,59

HM
PLAQUETTES

EN847-1

EXPERT

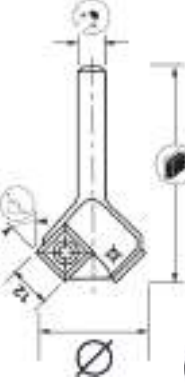

DEF.81A.68

MÈCHE D'AFFLEUREUSE À PLAQUETTES RÉVERSIBLES

- Affleurage à 30° ou 45° suivant un gabarit.



BOIS, MÉLAMINÉ

Ø	Ø	Ø	Z	Ø	REF	REF	€
26	6	47	2	30°	816.730.00	3510788167019	75,59
29	6	51	2	45°	816.745.00	3510788167026	75,59
26	8	47	2	30°	818.730.00	3510788187017	75,59
29	8	51	2	45°	818.745.00	3510788187024	75,59

HM
PLAQUETTES

EN847-1

EXPERT

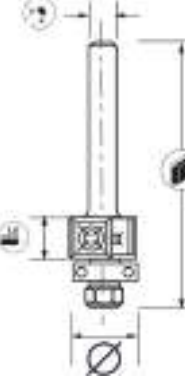

DEF.82.68

MÈCHE D'AFFLEUREUSE À PLAQUETTES RÉVERSIBLES + GUIDE

- Affleurage des chants dans le bois et panneaux mélaminés et stratifiés, en suivant un gabarit.



BOIS, MÉLAMINÉ

Ø	Ø	Ø	LU	Z	REF	REF	€
19	6	55	12	2	826.700.00	3510788267009	83,76
19	6	72	30	2	826.700.30	3510785436309	90,80
19	8	55	12	2	828.700.00	3510788287007	83,76
19	8	72	30	2	828.700.30	3510785425938	90,80

HM
PLAQUETTES

EN847-1

PANNEAUX ET DÉRIVÉS DU BOIS

EXPERT

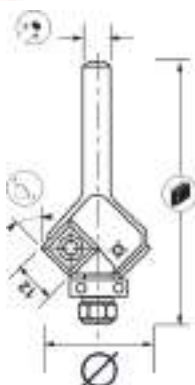

DEF.82A.68

MÈCHE D'AFFLEUREUSE À PLAQUETTES RÉVERSIBLES + GUIDE

- Affleurage à 30° ou 45° suivant un gabarit.

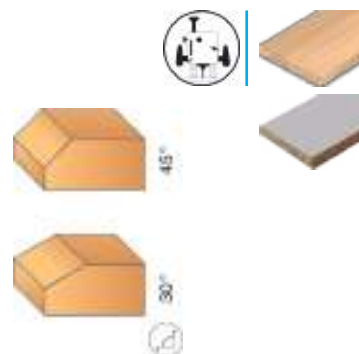

HM
PLAQUETTES

EN847-1

BOIS, MÉLAMINÉ

Ø	Ø	Ø	Z	Angle	REF	Code	€
26	6	62	2	30°	826.730.00	3510788267016	83,76
29	6	64	2	45°	826.745.00	3510788267023	83,76
26	8	62	2	30°	828.730.00	3510788287014	83,76
29	8	64	2	45°	828.745.00	3510788287021	83,76

RECHANGE : ROULEMENT (Ø 19) 890.002.04 - ROULEMENT (Ø 16) 890.002.03 -
PLAQUETTES (L 12) 0012.1215.00 - PLAQUETTES (L 30) 0030.1215.00

EXPERT

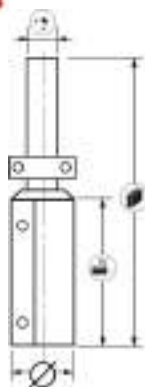

DEF.83.812

MÈCHE D'AFFLEUREUSE À PLAQUETTES RÉVERSIBLES + GUIDE SUPÉRIEUR

- Affleurage des chants dans le bois et panneaux mélaminés et stratifiés, en suivant un gabarit.

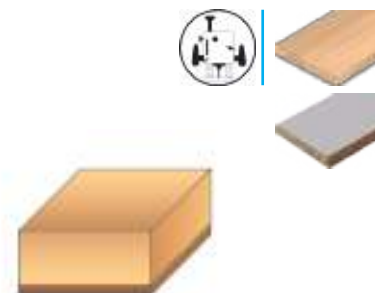

HM
PLAQUETTES

EN847-1

BOIS, MÉLAMINÉ

Ø	Ø	Ø	LU	Z	REF	Code	€
19	8	90	50	2	838.700.50	3510788387011	134,29
19	12	90	50	2	832.700.50	3510785401796	134,29

RECHANGE : ROULEMENT (Ø 19X8) 890.002.11 - ROULEMENT (Ø 19X12) 890.002.12 -
PLAQUETTES 02.2556.4 - CIRCLIPS (Ø 8) 890.001.08 - CIRCLIPS (Ø 12) 890.001.09

PANNEAUX ET DÉRIVÉS DU BOIS

EXPERT

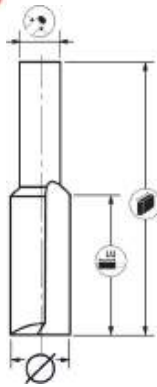

DEF.50.812

MÈCHE À RAINER DROITE

- Assemblage rainure, languette et coupe plongeante dans le bois.
- Travail sur machine C.N.C. possible.

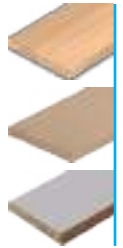

BOIS, MDF/HDF, MÉLAMINÉ

HM
MICROGRAIN

EN847-1

	Ø	Ø	Ø	LU	Z	REF		€
	7	8	57	19	2	508.707.00	3661589052063	31,01
	8	8	57	19	2	508.708.00	3661589052070	31,11
	9	8	55	19	2	508.709.00	3661589052087	32,63
	10	8	51	19	2	508.710.00	3661589052094	32,63
SÉRIE LONGUE	10	8	64	32	2	508.710.32	3661589052223	35,71
	11	8	51	19	2	508.711.00	3661589052100	32,63
	12	8	51	19	2	508.712.00	3661589052117	32,63
SÉRIE LONGUE	12	8	64	32	2	508.712.32	3661589052230	35,71
	13	8	51	19	2	508.713.00	3661589052124	32,63
	14	8	51	19	2	508.714.00	3661589052131	35,71
	15	8	51	19	2	508.715.00	3661589052148	35,71
SÉRIE LONGUE	15	8	64	32	2	508.715.32	3661589052261	38,85
	16	8	51	19	2	508.716.00	3661589052155	35,71
SÉRIE LONGUE	16	8	64	32	2	508.716.32	3661589052278	38,85
	18	8	51	19	2	508.718.00	3661589052162	37,39
SÉRIE LONGUE	18	8	64	32	2	508.718.32	3661589052285	41,08
	19	8	51	19	2	508.719.00	3661589052179	38,96
	20	8	51	19	2	508.720.00	3661589052186	38,96
SÉRIE LONGUE	20	8	64	32	2	508.720.32	3661589052292	41,50
	22	8	51	19	2	508.722.00	3661589052193	38,96
	25	8	51	19	2	508.725.00	3661589052209	40,65
	30	8	51	19	2	508.730.00	3661589052216	55,74
SÉRIE LONGUE	10	12	76	32	2	512.710.32	3661589052308	76,61
SÉRIE LONGUE	12	12	73	32	2	512.712.32	3661589052315	78,35
SÉRIE LONGUE	14	12	73	32	2	512.714.32	3661589052322	81,06
SÉRIE LONGUE	15	12	73	32	2	512.715.32	3661589052339	79,70
SÉRIE LONGUE	16	12	73	32	2	512.716.32	3661589052346	82,41
SÉRIE LONGUE	18	12	73	32	2	512.718.32	3661589052353	87,87
SÉRIE LONGUE	20	12	73	32	2	512.720.32	3661589052360	90,58
SÉRIE LONGUE	22	12	73	32	2	512.722.32	3661589052377	93,34
SÉRIE LONGUE	25	12	73	32	2	512.725.32	3661589052384	110,54
SÉRIE LONGUE	30	12	73	32	2	512.730.32	3661589052391	135,55
SÉRIE LONGUE	35	12	73	32	2	512.735.32	3661589052407	142,51

Mèches de diamètre < à 7 mm : carbure monobloc.

PANNEAUX ET DÉRIVÉS DU BOIS

EXPERT

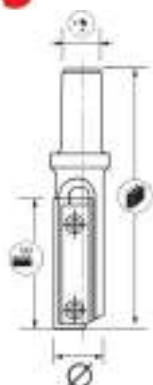

DEF.80.812

MÈCHE À RAINER À PLAQUETTE CROCHET AU TITANE

- Couteau 4 coupes en carbure massif au titane.
- Forme crochet pour une meilleure évacuation des copeaux.
- Rainurage et affleurage.



BOIS, MÉLAMINÉ

HM
PLAQUETTES

TITANE

EN847-1

	Ø			LU	Z	REF		€
	8	8	63	20	1	808.708.01	3510788007100	96,04
	10	8	63	20	1	808.710.01	3510788007117	96,04
	12	8	63	20	1	808.712.01	3510788007124	96,04
	14	8	76	30	1	808.714.01	3510788007131	113,15
	15	8	76	30	1	808.715.01	3510788007148	113,15
	16	8	76	30	1	808.716.01	3510788007155	113,15
	18	8	76	30	1	808.718.01	3510788007162	123,09
	20	8	76	30	1	808.720.01	3510785436279	123,09
	22	8	76	30	1	808.722.01	3510785426072	123,09
	10	12	68	20	1	802.710.01	3510788007315	96,04
	12	12	68	20	1	802.712.01	3510788007322	96,04
	14	12	74	30	1	802.714.01	3510788007339	113,15
SÉRIE LONGUE	14	12	94	50	1	802.714.51	3510785436286	128,83
	15	12	74	30	1	802.715.01	3510788007346	113,15
	16	12	74	30	1	802.716.01	3510788007353	113,15
SÉRIE LONGUE	16	12	94	50	1	802.716.51	3510785436293	128,83
	18	12	74	30	1	802.718.01	3510788007360	123,09
SÉRIE LONGUE	18	12	94	50	1	802.718.51	3510785435296	128,83
	20	12	74	30	1	802.720.01	3510788007377	123,09
SÉRIE LONGUE	20	12	94	50	1	802.720.51	3510785435302	128,83
	22	12	74	30	1	802.722.01	3510788007384	123,09
SÉRIE LONGUE	22	12	94	50	1	802.722.51	3510785435319	128,83

RECHANGE : PLAQUETTES SÉRIE FPL.800TI

PANNEAUX ET DÉRIVÉS DU BOIS

EXPERT



DEF.80.SCH

MÈCHE À RAINER À PLAQUETTE CROCHET AU TITANE

- Couteau 4 coupes en carbure massif au titane.
- Forme crochet pour une meilleure évacuation des copeaux.
- Rainurage et affleurage.
- Filetage intérieur M10 X 1,5.



BOIS, MÉLAMINÉ

HM
PLAQUETTES
TITANE
EN847-1

	Ø			LU	Z	REF		€
	10	SCHEER	58	20	1	803.710.01	3510788007414	114,66
	12	SCHEER	58	20	1	803.712.01	3510788007421	114,66
	14	SCHEER	65	30	1	803.714.01	3510788007438	131,43
SÉRIE LONGUE	14	SCHEER	85	50	1	803.714.51	3510785435326	138,74
	15	SCHEER	65	30	1	803.715.01	3510788007445	131,43
	16	SCHEER	65	30	1	803.716.01	3510788007452	131,43
SÉRIE LONGUE	16	SCHEER	85	50	1	803.716.51	3510785435333	138,74
	18	SCHEER	65	30	1	803.718.01	3510788007469	138,41
SÉRIE LONGUE	18	SCHEER	85	50	1	803.718.51	3510785435340	138,74
	20	SCHEER	65	30	1	803.720.01	3510788007476	138,41
SÉRIE LONGUE	20	SCHEER	85	50	1	803.720.51	3510785435357	138,74
	22	SCHEER	65	30	1	803.722.01	3510788007483	154,81
SÉRIE LONGUE	22	SCHEER	85	50	1	803.722.51	3510785435364	138,74

RECHANGE : PLAQUETTES SÉRIE FPL.800TI

PANNEAUX ET DÉRIVÉS DU BOIS

EXPERT

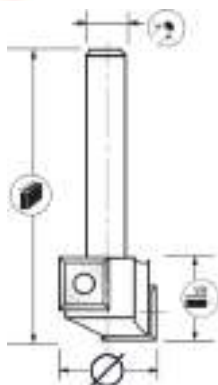

DEF.81.812

MÈCHE À RAINER À 2 PLAQUETTES RÉVERSIBLES

- Coupe latérale et frontale.
- Couteau en carbure massif réversible, 4 coupes.
- Rainurage en profondeur et coupe plongeante dans le bois.

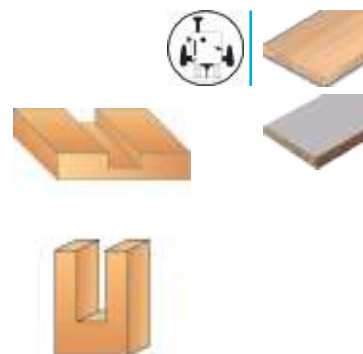

BOIS, MÉLAMINÉ

HM

EN847-1

Ø	⊘	⊞	LU	Z	REF	⊞	€
15	8	70	20	1+1	808.715.00	3510788087003	122,01
16	8	70	20	1+1	808.716.00	3510788087010	122,01
18	8	70	20	1+1	808.718.00	3510788087027	122,01
20	8	70	20	1+1	808.720.00	3510788087034	122,01
22	8	70	20	1+1	808.722.00	3510788087041	122,01
15	12	70	20	1+1	812.715.00	3510788127006	127,47
16	12	70	20	1+1	812.716.00	3510788127013	127,47
18	12	70	20	1+1	812.718.00	3510788127020	127,47
20	12	70	20	1+1	812.720.00	3510788127037	127,47

RECHANGE : PLAQUETTE 0012.1215.00 - CLE 890.001.02 - VIS 890.001.01

PANNEAUX ET DÉRIVÉS DU BOIS

EXPERT

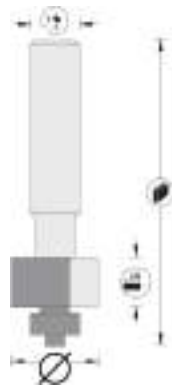

DEF.462.12

MÈCHE À FEUILLURER + GUIDE

- Feuillurage dans le bois en suivant un gabarit.
- Roulement interchangeable pour différentes profondeurs.

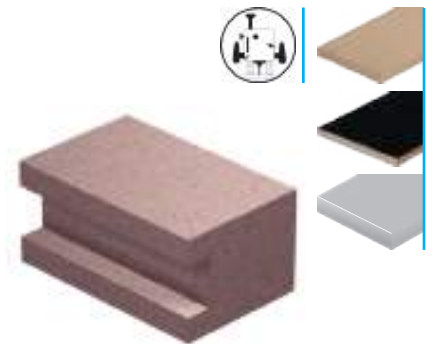

MDF/HDF, STRATIFIÉ, CORIAN

HM
MICROGRAIN

EN847-1

Ø	L	H	LU	Z	REF	REF	€
22	12	79	9,5	2	4622.722.00	3510785435371	66,01

RECHANGE : ROULEMENT 890.002.59

EXPERT



DEF.458.12

MÈCHE À CHANFREINER ET BISEAUTER + GUIDE «DELRIN®»

- Chanfreinage et biseautage des bois durs et abrasifs en suivant un gabarit.

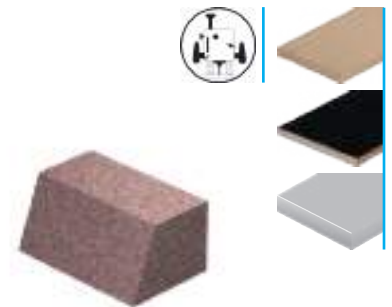

MDF/HDF, STRATIFIÉ, CORIAN

HM
MICROGRAIN

EN847-1

Ø	L	H	LU	Z	ANGLE	REF	REF	€
32	12	80	25,4	2	12°	4582.732.00	3510785413232	178,55

RECHANGE : ROULEMENT 890.002.52

EXPERT



DEF.452.12

MÈCHE POUR DÉCOUPE ARRONDIE + GUIDE «DELRIN®»

- Moulure décorative dans le bois en suivant un gabarit.

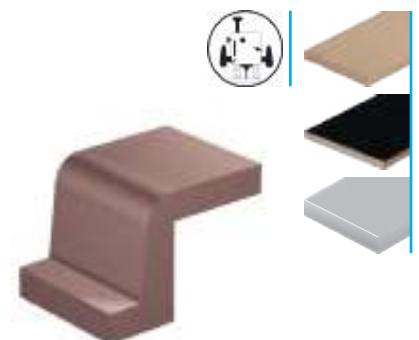

MDF/HDF, STRATIFIÉ, CORIAN

HM
MICROGRAIN

EN847-1

Ø	L	H	LU	Z	ANGLE	R	REF	REF	€
54	12	79	24,4	2	18°	13,00	4522.718.00	3510785413256	204,91

RECHANGE : ROULEMENT 890.002.52

PANNEAUX ET DÉRIVÉS DU BOIS

EXPERT

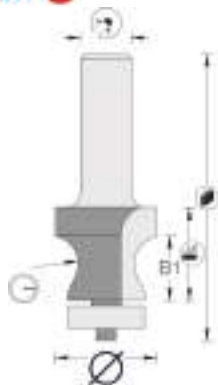

DEF.453.12

MÈCHE POUR COIN SUPÉRIEUR + GUIDE «DELRIN®»

- Moulure décorative dans le bois en suivant un gabarit.



MDF/HDF, STRATIFIÉ, CORIAN

HM
MICROGRAIN

EN847-1

Ø	Ø	Ø	LU	Z	Ø	REF	Ø	€
25	12	77	23	2	8,00	4532.708.00	3510785413263	127,74

RECHANGE : ROULEMENT 890.002.53

EXPERT



DEF.450.12

MÈCHE À RAINER DROITE

- Mèche une coupe avec coupe frontale.
- Rainurage et affleurage des bois durs et abrasifs.



MDF/HDF, STRATIFIÉ, CORIAN

HM
MICROGRAIN

EN847-1

Ø	Ø	Ø	LU	Z	REF	Ø	€
9,5	12	70	25,4	1	4502.709.00	3510785413201	35,82

PANNEAUX ET DÉRIVÉS DU BOIS

EXPERT



DEF.45.12

MÈCHE D'AFFLEUREUSE DROITE + GUIDE SUPÉRIEUR

- Affleurage des bois durs et abrasifs en suivant un gabarit.



MDF/HDF, STRATIFIÉ, CORIAN

HM
MICROGRAIN

EN847-1

Ø	L	B	LU	Z	REF	REF	€
28,6	12	92	38,1	2	4512.729.00	3510785413225	111,62

RECHANGE : ROULEMENT 890.002.51

EXPERT



DEF.457.12

MÈCHE D'AFFLEUREUSE DROITE + GUIDE «DELRIN®»

- Assemblage en queue d'aronde dans le bois en suivant un gabarit.



MDF/HDF, STRATIFIÉ, CORIAN

HM
MICROGRAIN

EN847-1

Ø	L	B	LU	Z	REF	REF	€
19	12	80	25,4	2	4572.719.00	3510785413218	74,45

RECHANGE : ROULEMENT 890.002.53

EXPERT

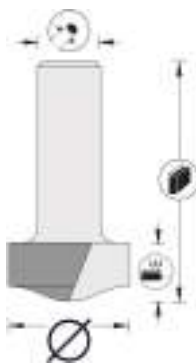

DEF.459.12

MÈCHE POUR COIN SUPÉRIEUR

- Moulure décorative dans le bois en suivant un gabarit.



MDF/HDF, STRATIFIÉ, CORIAN

HM
MICROGRAIN

EN847-1

Ø	L	B	LU	Z	REF	REF	€
25,4	12	54	12,7	2	4592.725.00	3510785413270	111,04

À combiner avec mèche : 4612.729.00

PANNEAUX ET DÉRIVÉS DU BOIS

EXPERT

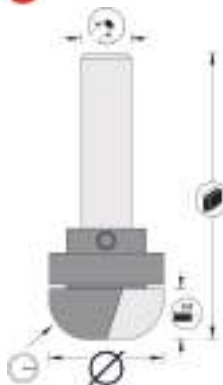

DEF.460.12

MÈCHE À GORGE + GUIDE SUPÉRIEUR
«DELRIN®»

- Affleurage en quart de cercle en suivant un gabarit.

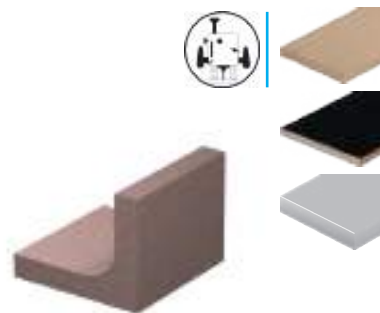

MDF/HDF, STRATIFIÉ, CORIAN

HM
MICROGRAIN

EN847-1

							REF		€
28,6	12	73	12,7	2	10,00	4602.729.00	3510785435425	67,90	

RECHANGE : ROULEMENT 890.002.56

EXPERT



DEF.46.12

MÈCHE 1/4 DE ROND + GUIDE

- Moulure décorative dans le bois en suivant un gabarit.

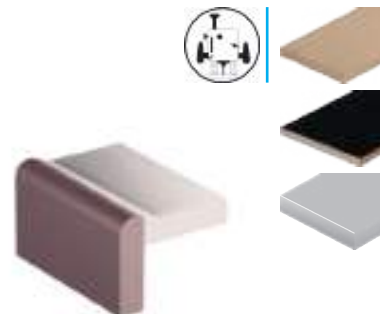

MDF/HDF, STRATIFIÉ, CORIAN

HM
MICROGRAIN

EN847-1

							REF		€
28,6	12	61	13,5	2	8,00	4612.729.00	3510785435418	77,54	

À combiner avec mèche : 4592.725.00. RECHANGE : ROULEMENT 890.002.54

EXPERT

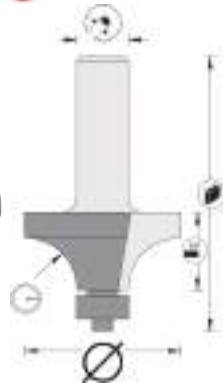

DEF.455.12

MÈCHE POUR DÉCOUPE ARRONDIE + GUIDE «DELRIN®»

- Moulure décorative dans le bois en suivant un gabarit.

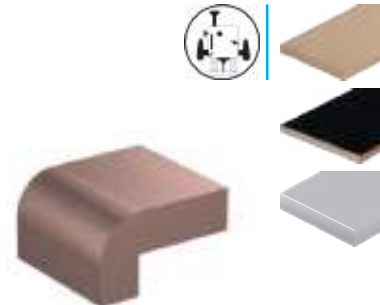

MDF/HDF, STRATIFIÉ, CORIAN

HM
MICROGRAIN

EN847-1

							REF		€
38,1	12	65	19	2	12,70	4552.713.00	3510785413287	92,15	

RECHANGE : ROULEMENT 890.002.54

CLASSIC

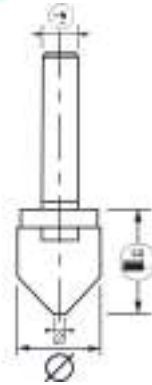

DEF.432A.8

MÈCHE À PLIER EN V POUR ALUCOBOND®

- Défonçage en V à 90° ou 135° dans l'Alucobond® et matériaux composites avant pliage.

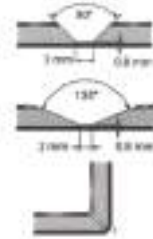

ALUMINIUM, MATÉRIAUX BASE METAL

HM

EN847-1

Ø	Ø	Z	Angle	REF	Icon	€
2 - 20	8	2	135°	4328.700.13	3510785435470	91,50
2 - 20	8	2	90°	4328.700.90	3510785435463	91,50

ACCESSOIRES



EN847-1

DEF.969.PM
MANDRIN PORTE-MÈCHE



	REF		€
M14 x 200	969.5.030.14	3510785434176	103,89
M16 x 200	969.5.050.16	3510785434183	103,89



EN847-1

DEF.969.612
PINÇE DE SERRAGE POUR PORTE-MÈCHE









\varnothing	REF		€
6	969.5.006	3510785434190	32,47
8	969.5.008	3510785434206	32,47
10	969.5.010	3510785434213	32,47
12	969.5.012	3510785434220	32,47

ACCESSOIRES



DEF.890.ROUL ROULEMENT

					REF		€
9,5		4,7			890.002.06	3510788902061	4,76
12,7		4,7			890.002.08	3510788902085	4,76
12,7		6,35			890.002.15	3661589053626	4,63
12,7		8			890.002.10	3510785416097	4,76
13		4			890.002.02	3510788902023	4,76
16		5			890.002.03	3510788902030	4,76
19		6			890.002.04	3510788902047	4,76
10		3			890.002.01	3510788902016	4,76
22		8			890.002.09	3510788902092	5,24
19		8			890.002.11	3510785413393	5,24
19		12			890.002.12	3510785413409	5,97
14		8			890.002.13	3661589042699	4,76
22,2		6,3	6,7	5°	890.002.50	3510785413348	19,38
28,6		12,7	8		890.002.51	3510785413355	16,01
21,8		6,3	6,7	10°	890.002.52	3510785413362	19,38
19,05		6,3	6,5		890.002.53	3510785413379	19,38
12,7		4,7	4,8		890.002.54	3510785413386	19,38
28,6		15	8,5		890.002.56	3510785435432	21,31
12,7	4,8	6,3	4,7		890.002.57	3510785435388	10,88
16	3,2	6,3	5		890.002.58	3510785435395	10,88
19	1,6	6,3	7		890.002.59	3510785435401	10,88





ACCESSOIRES



DEF.890.PM
MANDRIN PORTE-MECHE







			REF		€
M10 x 1,5	8		890.004.02	3510788904027	25,16
M12 x 1	8		890.004.05	3510788904058	25,16



DEF.890.MAN
MANCHON



				REF		€
8	25	6		890.005.01	3510788905017	10,56
8	25	6,35		890.005.02	3510788905024	10,56
10	25	8		890.005.05	3510788905055	10,56
12	25	6		890.005.06	3510788905062	10,56
12	25	8		890.005.07	3510788905079	10,56
12	25	10		890.005.08	3510788905086	10,56





DEF.890.VIS
VIS

	REF		€
TORX M4	890.001.01	3510785418749	3,96
M4	890.001.03	3510788901033	4,11
M3	890.001.04	3510788901040	3,41





DEF.800.VIS
VIS

			REF		€
M2,5 x 3	8 à 12		800.000.01	3510785418800	3,96
M4 x 4	14 à 22		800.000.02	3510785418756	3,96



DEF.800.CLE
CLÉ

			REF		€
CH 1,3	8 à 12		800.001.01	3510785418923	4,39
CH 2	14 à 22		800.001.02	3510785418947	4,39





DEF.890.CLE
CLÉ

	REF		€
TORX T15	890.001.02	3510785418930	5,83



DEF.890.CIR
CIRCLIPS

		REF		€
8		890.001.08	3661589061256	0,43
12		890.001.09	3661589061263	0,43





info@leman-sa.com

ALÉSAGE 30

-  **BOIS MASSIF** P. 242
-  **PANNEAUX ET DÉRIVÉS DU BOIS** P. 277
-  **ACCESSOIRES** P. 281

CLASSIC  pour les travaux courants et polyvalents.

 **WorkHardWorkFine**

BOIS MASSIF



EN847-1

LEMAXIMUM COFFRET SPÉCIAL COMBINÉ



BOIS

REF		€
LEMAXIMUM	351078999992	473,30



Porte-outils à profiler, calibrer
ref.093.50.30
Ø 100 x 50 x Al 30
Z2 + V2



PROFILER-CALIBRER



1 Jeu de fers profilés n°203 jointage
ref.855.203



1 Guide à billes + roulement
ref.970.5.100.55.00 +
ref.970.5.055.30.00
Ø 100



1 Jeu de fers profilés n°231 double plate-bande
ref.855.231



1 fraise à rainer
ref.937.120.30.0510
Ø 120 x 30 x 5/9,5 HM Z4 + V4



RAINER



1 Jeu de fers profilés n°232 profil / contre/profil
ref.855.232



1 Porte-outils extensible
ref.928.150.30.2039
Ø 150 x 20 - 30/39 Z4+V4



TENONNER + RAINER



3 Mèches à mortaiser gauche type 322 Ø 6/8/10

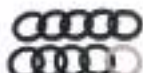

1 Jeu de bagues de réglages + clés de montage
ref.964.5.045.30.00



1 cylindre ponceur
Hauteur 120 mm
ref.062.120.30
Ø 62 - Grain 100



MORTAISER



1 Lame de finition bois denture alternée
ref.338.250.30.80
Ø 250 x 30 x 80 Z



SCIER



Accompagné du guide utilisateur : conseils et illustrations de l'utilisation des outils.

BOIS MASSIF

CLASSIC



CUISINE.ISO

COFFRET SPÉCIAL PORTES DE CUISINE



EN847-1

BOIS

REF		€
CUISINE.ISO	3661589037732	324,54



Porte-outils à profiler, calibrer
ref.093.50.30
Ø 100 x 50 x Al 30
Z2 + V2



PROFILER-CALIBRER



1 Jeu de fers
profilés n°203
jointage
ref.855.203



1 Jeu de fers
profilés n°232
profil /
contre/profil
ref.855.232



1 Jeu de fers
profilés n°231
double
plate-bande
ref.855.231



1 Guide à billes +
roulement
ref.970.5.100.55.00 +
ref.970.5.055.30.00
Ø 100



1 fraise à rainer
ref.937.120.30.0510
Ø 120 x 30 x 5/9,5 HM
Z4 + V4



RAINER



1 Jeu de bagues de
réglages + clés de
montage
ref.964.5.045.30.00

BOIS MASSIF



ALE.987.451

PORTE-OUTILS PROFILS ET CONTRE-PROFILS

- Profilage et contre-profilage pouvant exécuter 4 profils différents.
- Bois de 23 mm d'épaisseur minimum.
- Profils n°452, 453 et 454 adaptables.
- Cumulable avec la fraise tenon 20-39 ou 14-28.
- Réalisation de tenons de 50 mm.

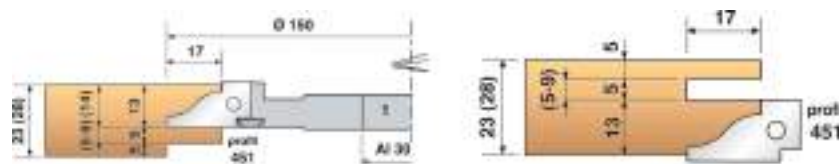
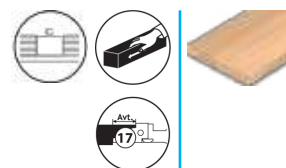

HM
PLAQUETTES **EN847-1**

BOIS

Livré avec le profil n°451.

Description	Ø	⊙	▮	U	Z	REF	🔍	€
PROFIL PAR-DESSOUS / CONTRE-PROFIL PAR-DESSUS	150	30	14	17	2	987.150.30.451	3510785419128	327,01



ALE.987.461

PORTE-OUTILS PROFILS ET CONTRE-PROFILS

- Profilage et contre-profilage pouvant exécuter 4 profils différents.
- Bois de 23 mm d'épaisseur minimum.
- Profils n°462, 463 et 464 adaptables.
- Cumulable avec la fraise tenon 20-39 ou 14-28.
- Réalisation de tenons de 50 mm.

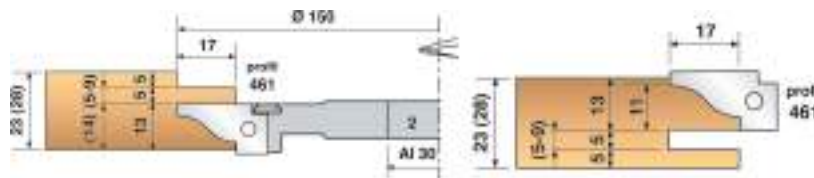
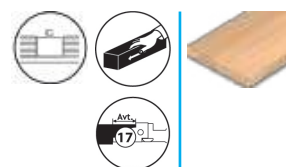

HM
PLAQUETTES **EN847-1**

BOIS

Livré avec le profil n°461.

Description	Ø	⊙	▮	U	Z	REF	🔍	€
PROFIL PAR-DESSUS / CONTRE-PROFIL PAR-DESSOUS	150	30	14	17	2	987.150.30.461	3510785419234	327,01

BOIS MASSIF

CLASSIC



ALE.987

PLAQUETTES CARBURE PROFILÉES

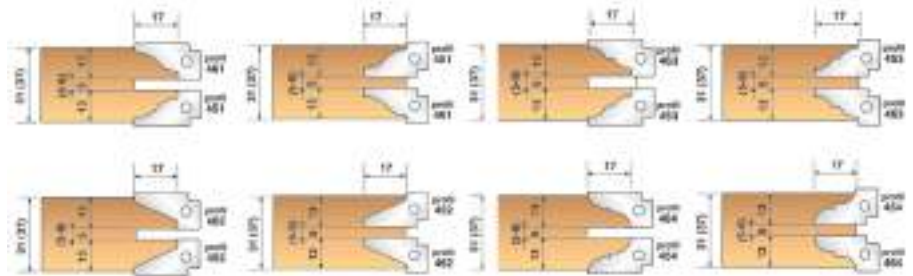
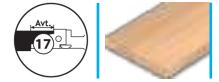

HM
PLAQUETTES

BOIS

					REF		€
14	17	30	2	1	451	3510785420650	70,65
14	17	30	2	1	452	3510785419388	70,65
14	17	30	2	1	453	3510785419494	70,65
14	17	30	2	1	454	3510785420674	70,65
14	17	30	2	1	461	3510785420667	70,65
14	17	30	2	1	462	3510785419470	70,65
14	17	30	2	1	463	3510785419623	70,65
14	17	30	2	1	464	3510785420148	70,65

CLASSIC



ALE.00662

PORTE-OUTILS HÉLICOÏDAL



- Permet de calibrer, chantourner et dresser.
- Coupe progressive précise.
- Livré avec guide à billes.

HM
PLAQUETTES

EN847-1

BOIS

RECHANGE : ARASEUR (14 x 14 x 2) 0014.1420.00 - VIS M5x8 TORX G32.05.006.25

						REF		€
	62	30	80		12	662.080.30	3510786628031	210,90
ROULEMENT	62	30		16		970.5.062.30.00	3510789700628	20,11

BOIS MASSIF

CLASSIC



ALE.938.A90

PORTE-OUTILS POUR BOUVETAGE DE TIROIR À 90°



- Bouvetage tiroir en alliage léger.
- Assemblages à 90°.

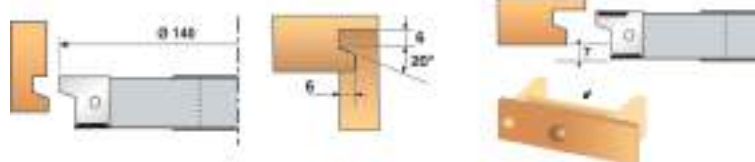

HM
PLAQUETTES

EN847-1

BOIS

RECHANGE : ARASEUR (14 x 14 x 2) 0014.1420.00

	Ø						Z	REF		€
	140	30	20				2+V2+2	938.9.140.30.20	3510789381056	275,37
2 PLAQUETTES BOUVETAGE				20	20	2	1	09.1805	3510785419609	66,78

CLASSIC



ALE.00978

PORTE-OUTILS POUR BOUVETAGE EN DENTS DE SCIE



- Pour jointer 2 pièces de bois en maximisant la surface de collage.
- 2 plaquettes dents de scie.
- Livré avec bague d'épaisseur 2,5 mm pour réglage entre 2 passes.

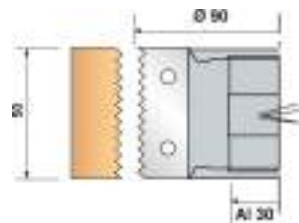

HM
PLAQUETTES

EN847-1

BOIS

	Ø						Z	REF		€
	90	30	50				2	978.090.30.5000	3510789789050	258,16
BAGUE	45	30				2,5		964.5.045.30.025	3510785419883	5,29
2 PLAQUETTES DENTS DE SCIE				50	12	1,5	1	09.1301	3510785419203	67,62

BOIS MASSIF

CLASSIC



ALE.938.A45

PORTE-OUTILS POUR BOUVETAGE D'ANGLE À 45°



- Bouvetage d'angle et assemblages à 45° pour rainure et languette.
- Réalisation de fausses poutres, tiroirs et caissons.



HM
PLAQUETTES

EN847-1

BOIS

	∅	Ø		▭	▭	⊕	Z	REF		€
	140	30	13-28				2	938.9.140.30.1328	3661589040626	301,16
2 PLAQUETTES BOUVETAGE				40	23	2	1	09.1801	3510785419074	137,66

CLASSIC



ALE.00075

PORTE-OUTILS CHANFREIN À 45°



- Assemblage de moulures non contre-profilables et tous profils.
- Réalisation de chanfreins à 45°.
- Adaptable sur arbre en alésage 50 avec vis M16 non fournie.
- Livré avec vis M14.

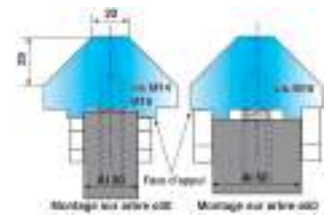

HM
PLAQUETTES

EN847-1

BOIS

RECHANGE : PLAQUETTES (14 x 14 x 2) 0014.1420.00.

Description	∅		Z	REF		€
	75/20	29	6	075.45.30	3661589040619	172,08
VIS DE MONTAGE M14/M16				0014.0016.00	3510788903051	11,53

BOIS MASSIF



HM
PLAQUETTES

EN847-1

ALE.AJ928

PORTE-OUTILS AJUSTABLE FEUILLURE ET TENON



- Porte-outils à tenon et feuillure avec araseurs inférieurs et supérieurs.
- Bagues d'extension non fournies.
- Porte-outils Ø 150 mm cumulable avec Porte-outils profils.

BOIS

RECHANGES ET ACCESSOIRES ALE.AJ928

Ø	Ø	Ø	Z	REF		€
140	30	14-28	4+V4	928.140.30.1428	3510789281486	200,78
150	30	14-28	4+V4	928.150.30.1428	3510789281585	210,90
150	30	20-39	4+V4	928.150.30.2039	3510789281516	210,90
170	30	20-39	4+V4	928.170.30.2039	3510785419012	263,89



HM
PLAQUETTES

EN847-1

ALE.00928

PORTE-OUTILS FEUILLURE ET TENON



- Porte-outils à tenon et feuillure en alliage léger.
- Montage possible en bout d'arbre pour la réalisation de tenons longs.

BOIS

RECHANGES ET ACCESSOIRES : VISARASEUR / G32.05.006.25

Ø	Ø	Ø	Z	REF		€
150	30	30	4+V4	928.150.30.3000	3510785435487	163,79
200	30	30	4+V4	928.200.30.3000	3510789282001	263,89

BOIS MASSIF

CLASSIC



ALE.0F937

FRAISE À RAINER EXTENSIBLE



- Fraise Ø 150 mm cumulable avec Porte-outils profils / contre-profils.
- Ajout possible d'une fraise intermédiaire.
- Bagues de réglage non fournies.

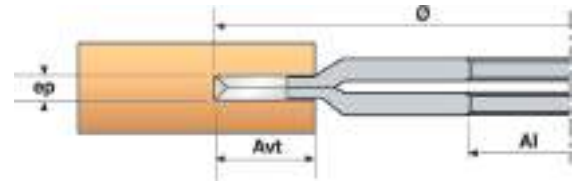

HM

EN847-1

BOIS

Description	Ø	Avt	Al	Z	REF	IBB	€	
	120	30	5-9,5	17	4+V4	937.120.30.0510	3510789371200	83,23
	150	30	5-9,5	20	4+V4	901.150.30.0510	3510789011502	117,66
FRAISE INTERMÉDIAIRE	120	30	10	17	4	937.120.30.0010	3661589038197	51,64
FRAISE INTERMÉDIAIRE	150	30	10	20	4	901.150.30.0010	3510789011519	65,96

CLASSIC



ALE.00967

PORTE-OUTILS MULTI 1/4 DE ROND



- Diamètre de base 100 mm.
- Permet d'obtenir 5 rayons différents selon les plaquettes utilisées.

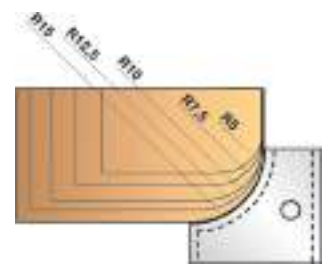

HM
PLAQUETTES

EN847-1

BOIS

Livré avec 2 plaquettes de rayon 7,5.

Description	Ø	Avt	Al	Z	REF	IBB	€			
	130	30	25	7,50	2	967.130.3075	3510789671751	473,30		
JEU DE 2 PLAQUETTES R=5			25	20	5,00	2	1	09.00.05	3510785419401	73,68
JEU DE 2 PLAQUETTES R=7,5			25	20	7,50	2	1	09.00.75	3510785419562	73,68
JEU DE 2 PLAQUETTES R=10			25	25	10,00	2	1	09.00.10	3510785419425	73,68
JEU DE 2 PLAQUETTES R=12			25	25	12,00	2	1	09.00.12	3510785419586	73,68
JEU DE 2 PLAQUETTES R=15			25	30	15,00	2	1	09.00.15	3510785419340	73,68

BOIS MASSIF

CLASSIC



ALE.0F967
FRAISE 1/4 DE ROND

- Fraise carbure brasé.
- Travail par-dessous.
- Réalisation de 1/4 de rond avec ou sans carré.

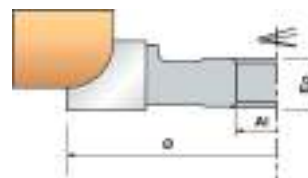

HM EN847-1

BOIS

Description	Ø	L	A	Z	REF	Barcode	€	
PAR-DESSOUS	120	30	15	8,00	2	967.120.3008	3510789670082	113,97
PAR-DESSOUS	120	30	15	10,00	2	967.120.3010	3510789670105	113,97
PAR-DESSOUS	120	30	17	12,00	2	967.120.3012	3510789670129	124,35

CLASSIC



ALE.0F944
FRAISE À PROFIL CONGÉ TONNEAU

- Fraise carbure brasé.
- Réalisation de plates-bandes pour panneaux de porte.
- Travail par-dessus.

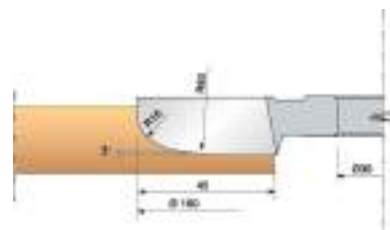

HM EN847-1

BOIS

Description	Ø	L	A	Z	REF	Barcode	€
PAR-DESSUS	160	30	20	2	944.160.30.3000	3510789441606	158,97

BOIS MASSIF

CLASSIC



ALE.0F947 FRAISE PLATE-BANDE

- Fraise carbure brasé.
- Réalisation de plates-bandes pour panneaux de porte.
- Travail par-dessus.

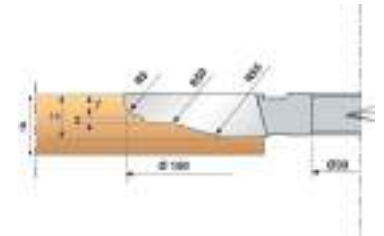

HM

EN847-1

BOIS

Description	Ø	•		Z	REF	REF	€
PAR-DESSUS	150	30	14	2	947.150.30.1400	3510789471504	119,22

CLASSIC



ALE.00948.07 PORTE-OUTILS PLATE-BANDE MULTI-PROFILS

- Permet d'adapter 7 profils différents.
- Positionnement automatique des plaquettes.
- Pente de 4°.

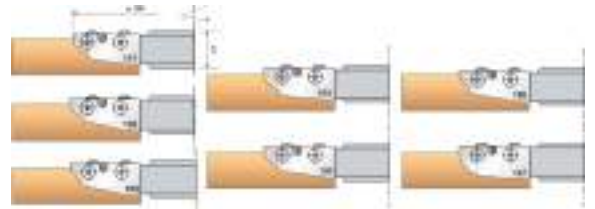

HM

PLAQUETTES

EN847-1

BOIS

Livré avec le profil n°101.

Description	Ø	•		■	▬	⊕	Z	REF	REF	€
PAR-DESSUS	180	30	23				2	948.180.30.101	3510789481800	317,13
PROFIL N°101 PAR-DESSUS				50	25	2	1	101	3510785420643	95,17
PROFIL N°102 PAR-DESSUS				50	25	2	1	102	3510785419289	95,17
PROFIL N°103 PAR-DESSUS				50	25	2	1	103	3510785419333	95,17
PROFIL N°104 PAR-DESSUS				50	25	2	1	104	3510785419593	95,17
PROFIL N°105 PAR-DESSUS				50	25	2	1	105	3510785419722	95,17
PROFIL N°106 PAR-DESSUS				50	25	2	1	106	3510785419678	95,17
PROFIL N°107 PAR-DESSUS				50	25	2	1	107	3510785419098	95,17
VIS								VIS948.180	3510785430642	4,55

BOIS MASSIF



ALE.00948

PORTE-OUTILS PLATE-BANDE MULTI-PROFILS



- Réalisation de 3 profils différents.
- Plaquettes réversibles.

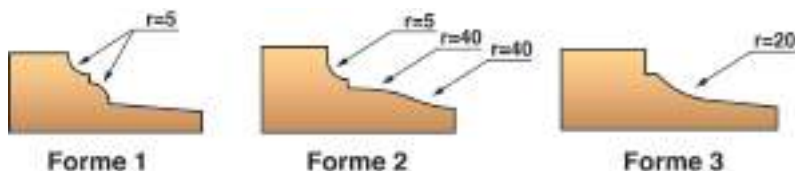

HM
PLAQUETTES

EN847-1

BOIS

Livré avec le profil n°1.

Description	Ø	⊘	⊥	⊞	⊞	⊞	Z	REF	⊞	€
PROFIL N°1 PAR-DESSUS	160	30	20				2	948.160.30.01	3510789481602	263,89
PROFIL N°1 PAR-DESSOUS	160	30	20				2	948.160.30.02	3510789481619	263,89
PROFIL N°1 PAR-DESSUS				50	16	2	2	09.1101	3510785419241	88,69
PROFIL N°2 PAR-DESSUS				50	16	2	2	09.1102	3510785419173	88,69
PROFIL N°3 PAR-DESSUS				50	16	2	2	09.1103	3510785419111	88,69
PROFIL N°1 PAR-DESSOUS				50	16	2	2	09.2101	3510785429943	88,69
PROFIL N°2 PAR-DESSOUS				50	16	2	2	09.2102	3510785429950	88,69
PROFIL N°3 PAR-DESSOUS				50	16	2	2	09.2103	3510785429967	88,69
VIS								VIS948.160	3510785430635	9,09



ALE.00958

PORTE-OUTILS INCLINABLE



- 2 coupes multi-pentes à plaquettes réversibles.
- Inclinaison des têtes réglable par palier de 7,5°.

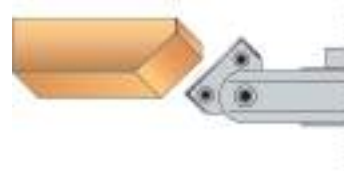

HM
PLAQUETTES

EN847-1

BOIS

RECHANGE : PLAQUETTE (40 x 12 x 1,5) 0040.1215.00

Ø	⊘	⊥	Z	REF	⊞	€
120	30	40	2	958.120.30.3001	3510789581210	258,16

BOIS MASSIF

CLASSIC



ALE.062.082

ROULEAU PONCEUR SUPPORT CAOUTCHOUC

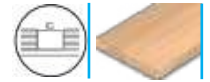

- Ponçage économique et propre de pièces courbes de petit diamètre.
- Manchons interchangeables.

BOIS

Livré avec manchon grain 100.

Description					REF		€
MANCHON VIS M14 POUR ALÉSAGE 30	60	30	120	100	062.120.30	3510780621205	40,23
	62	30	120	40	065.120.040	3510780650403	2,91
	62	30	120	60	065.120.060	3510780650601	2,91
	62	30	120	80	065.120.080	3510780650809	2,91
	62	30	120	100	065.120.100	3510780651004	2,91
	62	30	120	120	065.120.120	3510780651202	2,91
MANCHON VIS M16 POUR ALÉSAGE 50	80	50	120	100	082.120.50	3510785419067	51,64
	82	50	120	60	085.120.060	3510780850605	3,75
	82	50	120	80	085.120.080	3510780850803	3,75
	82	50	120	100	085.120.100	3510780851008	3,75
	82	50	120	120	085.120.120	3510780851206	3,75

CLASSIC



ALE.00722

MANCHON TOILE RIGIDE



- Abrasif corindon grains fermés.
- Montage sur rouleau ponceur.

BOIS

Livré par 10 pièces.

				REF		€
80	120	250	40	7225040	3661589072580	3,53
80	120	250	60	7225060	3661589017512	3,53
80	120	250	80	7225080	3661589017529	3,53
80	120	250	100	7225010	3661589017499	3,53
80	120	250	120	7225012	3661589017505	3,53
140	120	450	40	7245040	3661589072597	4,49
140	120	450	60	7245060	3661589017550	4,49
140	120	450	80	7245080	3661589017567	4,49
140	120	450	100	7245010	3661589017536	4,49
140	120	450	120	7245012	3661589017543	4,49

BOIS MASSIF



HSS

EN847-1

ALE.00068

PORTE-OUTILS À PROFILER - HT 40 MM



- Profilage et moulurage de bois massifs.
- Changement simultané des 2 fers portant la même référence en hauteur 40 mm uniquement.

						BOIS	
Ø	Ø		Z	REF		€	
68	20	40	2	068.40.20	3661589037886	119,09	
78	30	40	2	078.40.30	3661589037893	126,24	



HSS

EN847-1

ALE.00101

PORTE-OUTILS À PROFILER - HT 40 MM



- Profilage et moulurage de bois massifs.
- Changement simultané des 2 fers et contre-fers portant la même référence en hauteur 40 mm uniquement.
- Équipé de 2 fers à feuillurer et 2 contre-fers limiteurs de coupe.

						BOIS	
Ø	Ø		Z	REF		€	
100	30	40	2	101.40.30	3510781014037	177,88	
120	50	40	2	121.40.50	3510781214055	183,62	

Attention : ce porte-outils doit être utilisé avec les contre-fers correspondant aux fers profilés.

BOIS MASSIF



HSS

EN847-1

ALE.00104

PORTE-OUTILS À PROFILER - HT 50 MM



- Pour le travail de profilage et moulurage de bois massifs.
- Changement simultané des 2 fers et contre-fers : même référence, hauteur 50 mm uniquement.
- Équipé de 2 fers à feuillurer et 2 contre-fers limiteurs de coupe.

							BOIS
Ø	⊙	∥	Z	REF		€	
100	30	50	2	104.50.30	3510781045031	172,08	
120	50	50	2	124.50.50	3510781245059	199,36	

Attention : à utiliser avec les contre-fers correspondant aux fers profilés.



HSS

EN847-1

ALE.00090

PORTE-OUTILS À MOULURER - HT 90 MM



- Porte-outils en alliage léger 2 coupes permettant la réalisation de profils en une seule passe grâce à sa hauteur de 90 mm.
- Permet le montage de tous les fers hauteur 90 mm notamment utilisés pour la fabrication de corniche.
- Monter les 2 fers identiques pour chaque profil en même temps.
- Livré sans fers

							BOIS
Ø	⊙	∥	Z	REF		€	
90	30	90	2	090.90.30	3510780909037	200,78	
120	50	90	2	120.90.50	3510781209051	259,49	

BOIS MASSIF

ALE.00800 / ALE.00801
COUTEAUX PROFILÉS HT 40 MM

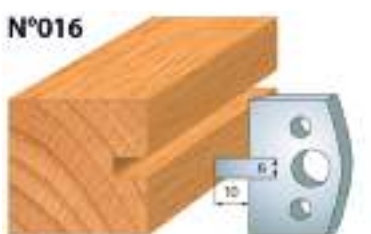
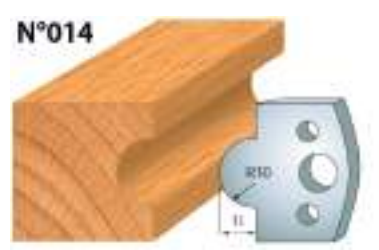

BOIS MASSIF

ALE.00800 / ALE.00801
COUTEAUX PROFILÉS HT 40 MM

N°018



N°019



N°021



N°022



N°024



N°025



N°028



N°029



N°030



N°031



N°033



N°034



N°035



N°036



N°038



BOIS MASSIF

ALE.00800 / ALE.00801
COUTEAUX PROFILÉS HT 40 MM

N°040



N°043



N°051



N°052



N°053



N°054



N°056



N°058



N°061



N°065



N°066



N°067



N°068



N°071



N°072



BOIS MASSIF

ALE.00800 / ALE.00801
COUTEAUX PROFILÉS HT 40 MM

N°073

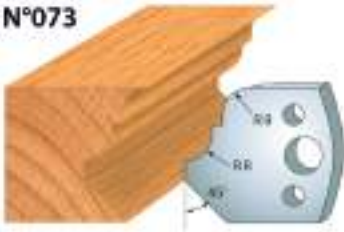

N°074



N°075



N°076



N°077



N°078

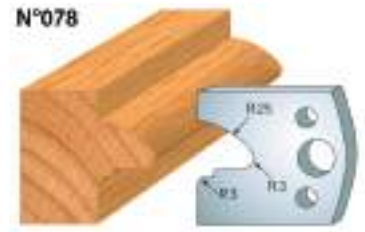

N°079

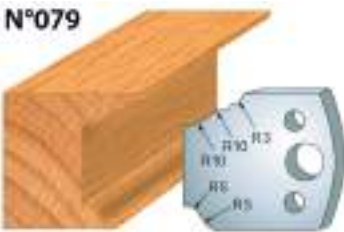

N°080

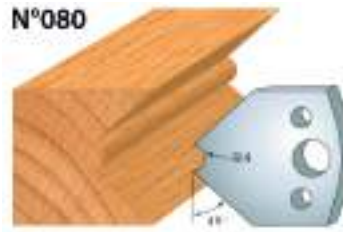

N°081



N°082



N°083



N°084



N°085



N°086



N°087



BOIS MASSIF

ALE.00800 / ALE.00801
COUTEAUX PROFILÉS HT 40 MM

N°089



N°090



N°091



N°092



N°094



N°095



N°096



N°097



N°098



N°099



N°100



N°101



N°102



N°103



N°104



BOIS MASSIF

ALE.00800 / ALE.00801
COUTEAUX PROFILÉS HT 40 MM

N°105



N°106



N°107



N°108



N°109



N°111

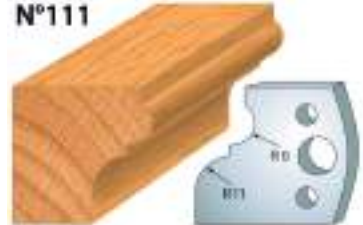

N°112



N°117



N°118



N°119



N°120

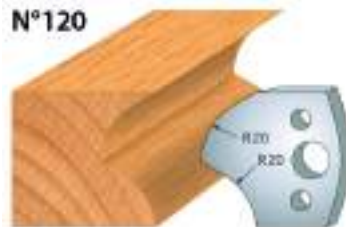

N°121



N°122



N°124



N°125



BOIS MASSIF

ALE.00800 / ALE.00801
COUTEAUX PROFILÉS HT 40 MM

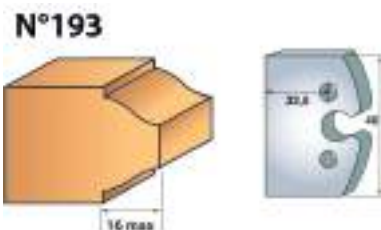







BOIS MASSIF

CLASSIC



ALE.00800

FERS HAUTEUR 40 MM

			REF		€
PROFIL N°000	40	4	800.000	3510788000002	15,81
PROFIL N°001	40	4	800.001	3510788000019	15,81
PROFIL N°003	40	4	800.003	3510788000033	15,81
PROFIL N°004	40	4	800.004	3510788000040	15,81
PROFIL N°005	40	4	800.005	3510788000057	15,81
PROFIL N°008	40	4	800.008	3510788000088	15,81
PROFIL N°009	40	4	800.009	3510788000095	15,81
PROFIL N°010	40	4	800.010	3510788000101	15,81
PROFIL N°011	40	4	800.011	3510788000118	15,81
PROFIL N°012	40	4	800.012	3510788000125	15,81
PROFIL N°013	40	4	800.013	3510788000132	15,81
PROFIL N°014	40	4	800.014	3510788000149	15,81
PROFIL N°015	40	4	800.015	3510788000156	15,81
PROFIL N°016	40	4	800.016	3510788000163	15,81
PROFIL N°017	40	4	800.017	3510788000170	15,81
PROFIL N°018	40	4	800.018	3510788000187	15,81
PROFIL N°019	40	4	800.019	3510788000194	15,81
PROFIL N°021	40	4	800.021	3510788000217	15,81
PROFIL N°022	40	4	800.022	3510788000224	15,81
PROFIL N°024	40	4	800.024	3510788000248	15,81
PROFIL N°025	40	4	800.025	3510788000255	15,81
PROFIL N°028	40	4	800.028	3510788000286	15,81
PROFIL N°029	40	4	800.029	3510788000293	15,81
PROFIL N°030	40	4	800.030	3510788000309	15,81
PROFIL N°031	40	4	800.031	3510788000316	15,81
PROFIL N°033	40	4	800.033	3510788000330	15,81
PROFIL N°034	40	4	800.034	3510788000347	15,81
PROFIL N°035	40	4	800.035	3510788000354	15,81
PROFIL N°036	40	4	800.036	3510788000361	15,81
PROFIL N°038	40	4	800.038	3510788000385	15,81
PROFIL N°040	40	4	800.040	3510788000408	15,81
PROFIL N°043	40	4	800.043	3510788000439	15,81
PROFIL N°051	40	4	800.051	3510788000514	15,81
PROFIL N°052	40	4	800.052	3510788000521	15,81
PROFIL N°053	40	4	800.053	3510788000538	15,81
PROFIL N°054	40	4	800.054	3510788000545	15,81

			REF		€
PROFIL N°056	40	4	800.056	3510788000569	15,81
PROFIL N°058	40	4	800.058	3510788000583	15,81
PROFIL N°061	40	4	800.061	3510788000613	15,81
PROFIL N°065	40	4	800.065	3510788000651	15,81
PROFIL N°066	40	4	800.066	3510788000668	15,81
PROFIL N°067	40	4	800.067	3510788000675	15,81
PROFIL N°068	40	4	800.068	3510788000682	15,81
PROFIL N°071	40	4	800.071	3510788000712	15,81
PROFIL N°072	40	4	800.072	3510788000729	15,81
PROFIL N°073	40	4	800.073	3510788000736	15,81
PROFIL N°074	40	4	800.074	3510788000743	15,81
PROFIL N°075	40	4	800.075	3510788000750	15,81
PROFIL N°076	40	4	800.076	3510788000767	15,81
PROFIL N°077	40	4	800.077	3510788000774	15,81
PROFIL N°078	40	4	800.078	3510788000781	15,81
PROFIL N°079	40	4	800.079	3510788000798	15,81
PROFIL N°080	40	4	800.080	3510788000804	15,81
PROFIL N°081	40	4	800.081	3510788000811	15,81
PROFIL N°082	40	4	800.082	3510788000828	15,81
PROFIL N°083	40	4	800.083	3510788000835	15,81
PROFIL N°084	40	4	800.084	3510788000842	15,81
PROFIL N°085	40	4	800.085	3510788000859	15,81
PROFIL N°086	40	4	800.086	3510788000866	15,81
PROFIL N°087	40	4	800.087	3510788000873	15,81
PROFIL N°089	40	4	800.089	3510788000897	15,81
PROFIL N°090	40	4	800.090	3510788000903	15,81
PROFIL N°091	40	4	800.091	3510788000910	15,81
PROFIL N°092	40	4	800.092	3510788000927	15,81
PROFIL N°094	40	4	800.094	3510788000941	15,81
PROFIL N°095	40	4	800.095	3510788000958	15,81
PROFIL N°096	40	4	800.096	3510788000965	15,81
PROFIL N°097	40	4	800.097	3510788000972	15,81
PROFIL N°098	40	4	800.098	3510788000989	15,81
PROFIL N°099	40	4	800.099	3510788000996	15,81
PROFIL N°100	40	4	800.100	3510788001009	15,81
PROFIL N°101	40	4	800.101	3510788001016	15,81
PROFIL N°102	40	4	800.102	3510788001023	15,81
PROFIL N°103	40	4	800.103	3510788001030	15,81
PROFIL N°104	40	4	800.104	3510788001047	15,81



BOIS MASSIF

			REF		€
PROFIL N°105	40	4	800.105	3510788001054	15,81
PROFIL N°106	40	4	800.106	3510788001061	15,81
PROFIL N°107	40	4	800.107	3510788001078	15,81
PROFIL N°108	40	4	800.108	3510788001085	15,81
PROFIL N°109	40	4	800.109	3510788001092	15,81
PROFIL N°111	40	4	800.111	3510788001115	15,81
PROFIL N°112	40	4	800.112	3510788001122	15,81
PROFIL N°117	40	4	800.117	3510788001177	15,81
PROFIL N°118	40	4	800.118	3510788001184	15,81
PROFIL N°119	40	4	800.119	3510788001191	15,81
PROFIL N°120	40	4	800.120	3510788001207	15,81
PROFIL N°121	40	4	800.121	3510788001214	15,81
PROFIL N°122	40	4	800.122	3510788001221	15,81
PROFIL N°124	40	4	800.124	3510788001245	15,81
PROFIL N°125	40	4	800.125	3510788001252	15,81
PROFIL N°126	40	4	800.126	3510788001269	15,81
PROFIL N°127	40	4	800.127	3510788001276	15,81
PROFIL N°128	40	4	800.128	3510788001283	15,81
PROFIL N°129	40	4	800.129	3510788001290	15,81
PROFIL N°131	40	4	800.131	3510788001313	15,81
PROFIL N°132	40	4	800.132	3510785419463	15,81
PROFIL N°172	40	4	800.172	3510788001726	15,81
PROFIL N°173	40	4	800.173	3510788001733	15,81
PROFIL N°174	40	4	800.174	3510788001740	15,81
PROFIL N°175	40	4	800.175	3510788001757	15,81
PROFIL N°176	40	4	800.176	3510788001764	15,81
PROFIL N°177	40	4	800.177	3510788001771	15,81



ALE.800H40.AP

FERS À PROFILER HAUTEUR 40 MM



			REF		€
	40	4,0	800.193	3510788001931	12,00
	38	3,8	801.193	3661589043450	12,00
			844.999	PROFILAGE SPÉCIAL	sur devis



BOIS MASSIF

CLASSIC



ALE.00801

CONTRE-FERS HAUTEUR 40 MM

			REF		€
PROFIL N°0	38	4	801.000	3510788010001	15,81
PROFIL N°1	38	4	801.001	3510788010018	15,81
PROFIL N°3	38	4	801.003	3510788010032	15,81
PROFIL N°4	38	4	801.004	3510788010049	15,81
PROFIL N°5	38	4	801.005	3510788010056	15,81
PROFIL N°8	38	4	801.008	3510788010087	15,81
PROFIL N°9	38	4	801.009	3510788010094	15,81
PROFIL N°10	38	4	801.010	3510788010100	15,81
PROFIL N°11	38	4	801.011	3510788010117	15,81
PROFIL N°12	38	4	801.012	3510788010124	15,81
PROFIL N°13	38	4	801.013	3510788010131	15,81
PROFIL N°14	38	4	801.014	3510788010148	15,81
PROFIL N°15	38	4	801.015	3510788010155	15,81
PROFIL N°16	38	4	801.016	3510788010162	15,81
PROFIL N°17	38	4	801.017	3510788010179	15,81
PROFIL N°18	38	4	801.018	3510788010186	15,81
PROFIL N°19	38	4	801.019	3510788010193	15,81
PROFIL N°21	38	4	801.021	3510788010216	15,81
PROFIL N°22	38	4	801.022	3510788010223	15,81
PROFIL N°24	38	4	801.024	3510788010247	15,81
PROFIL N°25	38	4	801.025	3510788010254	15,81
PROFIL N°28	38	4	801.028	3510788010285	15,81
PROFIL N°29	38	4	801.029	3510788010292	15,81
PROFIL N°30	38	4	801.030	3510788010308	15,81
PROFIL N°31	38	4	801.031	3510788010315	15,81
PROFIL N°33	38	4	801.033	3510788010339	15,81
PROFIL N°34	38	4	801.034	3510788010346	15,81
PROFIL N°35	38	4	801.035	3510788010353	15,81
PROFIL N°36	38	4	801.036	3510788010360	15,81
PROFIL N°38	38	4	801.038	3510788010384	15,81
PROFIL N°40	38	4	801.040	3510788010407	15,81
PROFIL N°43	38	4	801.043	3510788010438	15,81
PROFIL N°51	38	4	801.051	3510788010513	15,81
PROFIL N°52	38	4	801.052	3510788010520	15,81
PROFIL N°53	38	4	801.053	3510788010537	15,81
PROFIL N°54	38	4	801.054	3510788010544	15,81

			REF		€
PROFIL N°56	38	4	801.056	3510788010568	15,81
PROFIL N°58	38	4	801.058	3510788010582	15,81
PROFIL N°61	38	4	801.061	3510788010612	15,81
PROFIL N°65	38	4	801.065	3510788010650	15,81
PROFIL N°66	38	4	801.066	3510788010667	15,81
PROFIL N°67	38	4	801.067	3510788010674	15,81
PROFIL N°68	38	4	801.068	3510788010681	15,81
PROFIL N°71	38	4	801.071	3510788010711	15,81
PROFIL N°72	38	4	801.072	3510788010728	15,81
PROFIL N°73	38	4	801.073	3510788010735	15,81
PROFIL N°74	38	4	801.074	3510788010742	15,81
PROFIL N°75	38	4	801.075	3510788010759	15,81
PROFIL N°76	38	4	801.076	3510788010766	15,81
PROFIL N°77	38	4	801.077	3510788010773	15,81
PROFIL N°78	38	4	801.078	3510788010780	15,81
PROFIL N°79	38	4	801.079	3510788010797	15,81
PROFIL N°80	38	4	801.080	3510788010803	15,81
PROFIL N°81	38	4	801.081	3510788010810	15,81
PROFIL N°82	38	4	801.082	3510788010827	15,81
PROFIL N°83	38	4	801.083	3510788010834	15,81
PROFIL N°84	38	4	801.084	3510788010841	15,81
PROFIL N°85	38	4	801.085	3510788010858	15,81
PROFIL N°86	38	4	801.086	3510788010865	15,81
PROFIL N°87	38	4	801.087	3510788010872	15,81
PROFIL N°89	38	4	801.089	3510788010896	15,81
PROFIL N°90	38	4	801.090	3510788010902	15,81
PROFIL N°91	38	4	801.091	3510788010919	15,81
PROFIL N°92	38	4	801.092	3510788010926	15,81
PROFIL N°94	38	4	801.094	3510788010940	15,81
PROFIL N°95	38	4	801.095	3510788010957	15,81
PROFIL N°96	38	4	801.096	3510788010964	15,81
PROFIL N°97	38	4	801.097	3510788010971	15,81
PROFIL N°98	38	4	801.098	3510788010988	15,81
PROFIL N°99	38	4	801.099	3510788010995	15,81
PROFIL N°100	38	4	801.100	3510788011008	15,81
PROFIL N°101	38	4	801.101	3510788011015	15,81
PROFIL N°102	38	4	801.102	3510788011022	15,81
PROFIL N°103	38	4	801.103	3510788011039	15,81
PROFIL N°104	38	4	801.104	3510788011046	15,81

BOIS MASSIF

		REF		€	
PROFIL N°105	38	4	801.105	3510788011053	15,81
PROFIL N°106	38	4	801.106	3510788011060	15,81
PROFIL N°107	38	4	801.107	3510785420193	15,81
PROFIL N°108	38	4	801.108	3510788011084	15,81
PROFIL N°109	38	4	801.109	3510788011091	15,81
PROFIL N°111	38	4	801.111	3510788011114	15,81
PROFIL N°112	38	4	801.112	3510788011121	15,81
PROFIL N°117	38	4	801.117	3510788011176	15,81
PROFIL N°118	38	4	801.118	3510788011183	15,81
PROFIL N°119	38	4	801.119	3510788011190	15,81
PROFIL N°120	38	4	801.120	3510788011206	15,81
PROFIL N°121	38	4	801.121	3510788011213	15,81
PROFIL N°122	38	4	801.122	3510788011220	15,81
PROFIL N°124	38	4	801.124	3510788011244	15,81
PROFIL N°125	38	4	801.125	3510788011251	15,81
PROFIL N°126	38	4	801.126	3510788011268	15,81
PROFIL N°127	38	4	801.127	3510788011275	15,81
PROFIL N°128	38	4	801.128	3510788011282	15,81
PROFIL N°129	38	4	801.129	3510788011299	15,81
PROFIL N°131	38	4	801.131	3510788011312	15,81
PROFIL N°132	38	4	801.132	3510788011329	15,81
PROFIL N°172	38	4	801.172	3510788011725	15,81
PROFIL N°173	38	4	801.173	3510788011732	15,81
PROFIL N°174	38	4	801.174	3510788011749	15,81
PROFIL N°175	38	4	801.175	3510788011756	15,81
PROFIL N°176	38	4	801.176	3510788011763	15,81
PROFIL N°177	38	4	801.177	3510788011770	15,81

BOIS MASSIF

ALE.00855 / ALE.00856
COUTEAUX PROFILÉS HT 50 MM

N°200



N°201

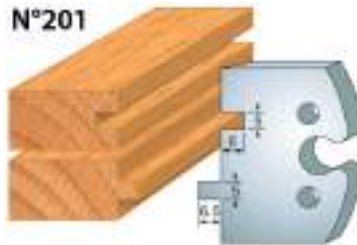

N°202

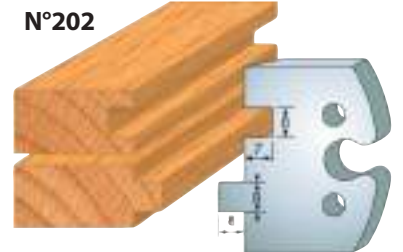

N°203



N°204



N°205

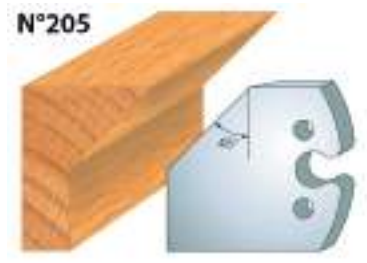

N°206



N°207

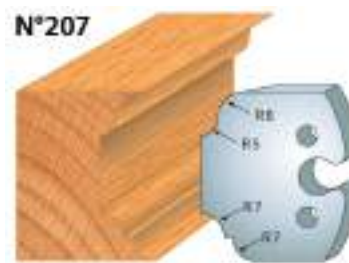

N°208



N°209

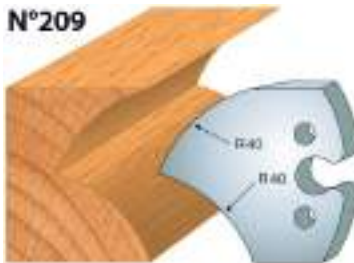

N°210



N°211

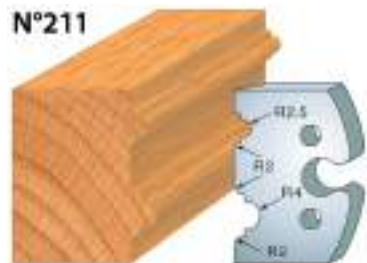

N°212



N°213



N°214



BOIS MASSIF

ALE.00855 / ALE.00856
COUTEAUX PROFILÉS HT 50 MM

N°215



N°216



N°217



N°218



N°219



N°220



N°221



N°222



N°223



N°224



N°225



N°226



N°227



N°228



N°229



BOIS MASSIF

ALE.00855 / ALE.00856 COUTEAUX PROFILÉS HT 50 MM

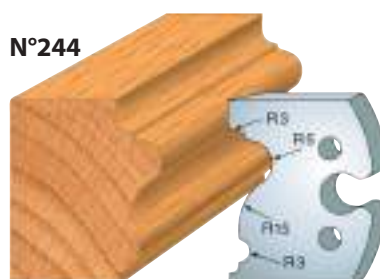
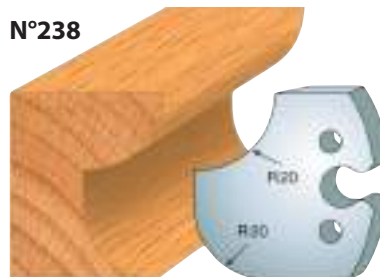
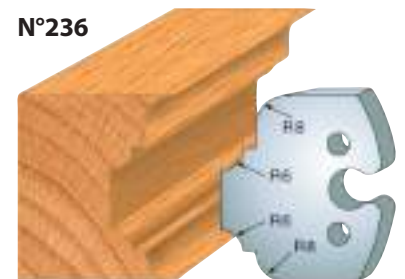
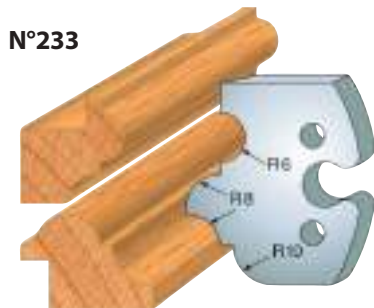
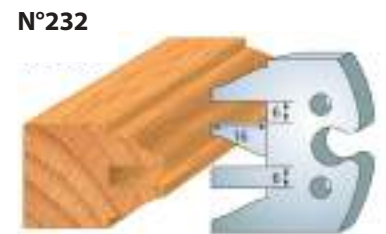

BOIS MASSIF

ALE.00855 / ALE.00856
COUTEAUX PROFILÉS HT 50 MM

N°246

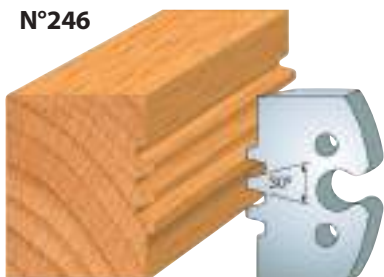

N°247

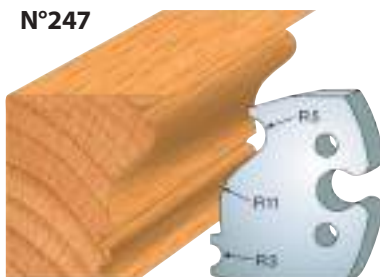

N°248



N°250



N°251

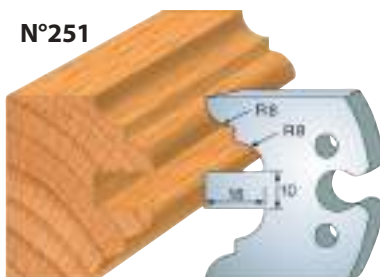

N°252



N°253



N°254



N°255



N°258



N°259



N°260



N°272

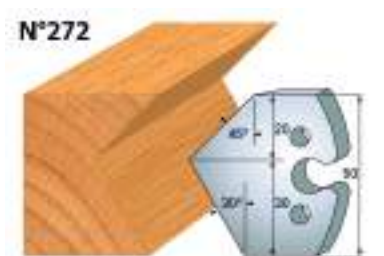

N°273



N°274



BOIS MASSIF

ALE.00855 / ALE.00856 COUTEAUX PROFILÉS HT 50 MM

N°275

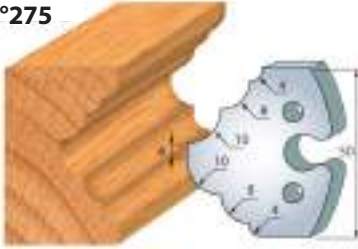

N°276



N°277

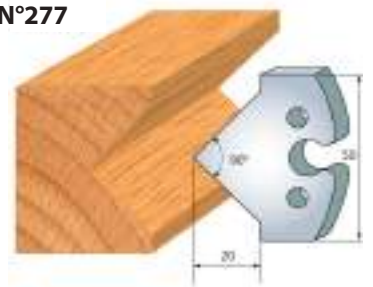

N°279



N°280



N°281



N°282



N°283

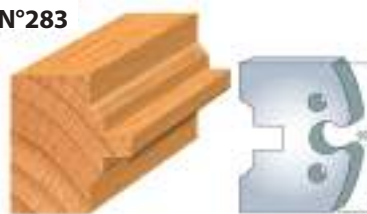

N°284



N°285



N°293

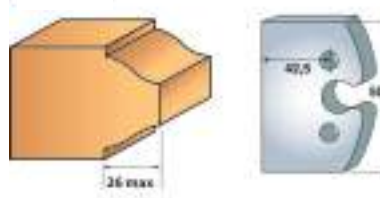

N°304



N°305



N°306



N°307









BOIS MASSIF

CLASSIC

ALE.00855

FERS HAUTEUR 50 MM

			REF		€
PROFIL N°200	50	5,5	855.200	3510788552006	25,85
PROFIL N°201	50	5,5	855.201	3510788552013	25,85
PROFIL N°202	50	5,5	855.202	3510788552020	25,85
PROFIL N°203	50	5,5	855.203	3510788552037	25,85
PROFIL N°204	50	5,5	855.204	3510788552044	25,85
PROFIL N°205	50	5,5	855.205	3510788552051	25,85
PROFIL N°206	50	5,5	855.206	3510788552068	25,85
PROFIL N°207	50	5,5	855.207	3510788552075	25,85
PROFIL N°208	50	5,5	855.208	3510788552082	25,85
PROFIL N°209	50	5,5	855.209	3510788552099	25,85
PROFIL N°210	50	5,5	855.210	3510788552105	25,85
PROFIL N°211	50	5,5	855.211	3510788552112	25,85
PROFIL N°212	50	5,5	855.212	3510788552129	25,85
PROFIL N°213	50	5,5	855.213	3510788552136	25,85
PROFIL N°214	50	5,5	855.214	3510788552143	25,85
PROFIL N°215	50	5,5	855.215	3510788552150	25,85
PROFIL N°216	50	5,5	855.216	3510788552167	25,85
PROFIL N°217	50	5,5	855.217	3510788552174	25,85
PROFIL N°218	50	5,5	855.218	3510788552181	25,85
PROFIL N°219	50	5,5	855.219	3510788552198	25,85
PROFIL N°220	50	5,5	855.220	3510788552204	25,85
PROFIL N°221	50	5,5	855.221	3510788552211	25,85
PROFIL N°222	50	5,5	855.222	3510788552228	25,85
PROFIL N°223	50	5,5	855.223	3510788552235	25,85
PROFIL N°224	50	5,5	855.224	3510788552242	25,85
PROFIL N°225	50	5,5	855.225	3510788552259	25,85
PROFIL N°226	50	5,5	855.226	3510788552266	25,85
PROFIL N°227	50	5,5	855.227	3510788552273	25,85
PROFIL N°228	50	5,5	855.228	3510788552280	25,85
PROFIL N°229	50	5,5	855.229	3510788552297	25,85
PROFIL N°230	50	5,5	855.230	3510788552303	25,85
PROFIL N°231	50	5,5	855.231	3510788552310	25,85
PROFIL N°232	50	5,5	855.232	3510788552327	25,85
PROFIL N°233	50	5,5	855.233	3510788552334	25,85
PROFIL N°235	50	5,5	855.235	3510788552358	25,85
PROFIL N°236	50	5,5	855.236	3510788552365	25,85



			REF		€
PROFIL N°237	50	5,5	855.237	3510788552372	25,85
PROFIL N°238	50	5,5	855.238	3510788552389	25,85
PROFIL N°239	50	5,5	855.239	3510788552396	25,85
PROFIL N°240	50	5,5	855.240	3510788552402	25,85
PROFIL N°241	50	5,5	855.241	3510788552419	25,85
PROFIL N°242	50	5,5	855.242	3510788552426	25,85
PROFIL N°243	50	5,5	855.243	3510788552433	25,85
PROFIL N°244	50	5,5	855.244	3510788552440	25,85
PROFIL N°245	50	5,5	855.245	3510788552457	25,85
PROFIL N°246	50	5,5	855.246	3510788552464	25,85
PROFIL N°247	50	5,5	855.247	3510788552471	25,85
PROFIL N°248	50	5,5	855.248	3510788552488	25,85
PROFIL N°250	50	5,5	855.250	3510788552501	25,85
PROFIL N°251	50	5,5	855.251	3510788552518	25,85
PROFIL N°252	50	5,5	855.252	3510788552525	25,85
PROFIL N°253	50	5,5	855.253	3510788552532	25,85
PROFIL N°254	50	5,5	855.254	3510788552549	25,85
PROFIL N°255	50	5,5	855.255	3510788552556	25,85
PROFIL N°258	50	5,5	855.258	3510788552587	25,85
PROFIL N°259	50	5,5	855.259	3510788552594	25,85
PROFIL N°260	50	5,5	855.260	3510788552600	25,85
PROFIL N°272	50	5,5	855.272	3510788552723	25,85
PROFIL N°273	50	5,5	855.273	3510788552730	25,85
PROFIL N°274	50	5,5	855.274	3510788552747	25,85
PROFIL N°275	50	5,5	855.275	3510788552754	25,85
PROFIL N°276	50	5,5	855.276	3510788552761	25,85
PROFIL N°277	50	5,5	855.277	3510788552778	25,85
PROFIL N°279	50	5,5	855.279	3510788552792	25,85
PROFIL N°280	50	5,5	855.280	3510788552808	25,85
PROFIL N°281	50	5,5	855.281	3510788552815	25,85
PROFIL N°282	50	5,5	855.282	3510788552822	25,85
PROFIL N°283	50	5,5	855.283	3510788552839	25,85
PROFIL N°284	50	5,5	855.284	3510788552846	25,85
PROFIL N°285	50	5,5	855.285	3510788552853	25,85
PROFIL N°286	50	5,5	855.286	3510788552860	25,85
PROFIL N°304	50	5,5	855.304	3510785434626	25,85
PROFIL N°305	50	5,5	855.305	3510785434633	25,85
PROFIL N°306	50	5,5	855.306	3510785434602	25,85
PROFIL N°307	50	5,5	855.307	3510785434619	25,85

BOIS MASSIF



ALE.855H50.AP



FERS À PROFILER HAUTEUR 50 MM



		REF		€
50	5,5	855.293	3510788552938	22,96
48	5,3	856.293	3661589043443	22,96
30		855.999	PROFILAGE SPÉCIAL	sur devis



ALE.00856

CONTRE-FERS HAUTEUR 50 MM

		REF		€
PROFIL N°200	48 5,3	856.200	3510785420025	25,85
PROFIL N°201	48 5,3	856.201	3510785419630	25,85
PROFIL N°202	48 5,3	856.202	3510785419432	25,85
PROFIL N°203	48 5,3	856.203	3510785419272	25,85
PROFIL N°204	48 5,3	856.204	3510785420001	25,85
PROFIL N°205	48 5,3	856.205	3510785419579	25,85
PROFIL N°206	48 5,3	856.206	3510785419616	25,85
PROFIL N°207	48 5,3	856.207	3510785420087	25,85
PROFIL N°208	48 5,3	856.208	3510785420094	25,85
PROFIL N°209	48 5,3	856.209	3510785419517	25,85
PROFIL N°210	48 5,3	856.210	3510785419890	25,85
PROFIL N°211	48 5,3	856.211	3510785419944	25,85
PROFIL N°212	48 5,3	856.212	3510785419661	25,85
PROFIL N°213	48 5,3	856.213	3510785419951	25,85
PROFIL N°214	48 5,3	856.214	3510785419838	25,85
PROFIL N°215	48 5,3	856.215	3510785419456	25,85
PROFIL N°216	48 5,3	856.216	3510785419647	25,85
PROFIL N°217	48 5,3	856.217	3510785419982	25,85
PROFIL N°218	48 5,3	856.218	3510785419784	25,85
PROFIL N°219	48 5,3	856.219	3510785419371	25,85
PROFIL N°220	48 5,3	856.220	3510785419548	25,85
PROFIL N°221	48 5,3	856.221	3510785420476	25,85
PROFIL N°222	48 5,3	856.222	3510785419746	25,85
PROFIL N°223	48 5,3	856.223	3510785420308	25,85
PROFIL N°224	48 5,3	856.224	3510785420216	25,85
PROFIL N°225	48 5,3	856.225	3510785420070	25,85
PROFIL N°226	48 5,3	856.226	3510785419685	25,85
PROFIL N°227	48 5,3	856.227	3510785419708	25,85
PROFIL N°228	48 5,3	856.228	3510785419807	25,85

			REF		€
PROFIL N°229	48	5,3	856.229	3510785419418	25,85
PROFIL N°230	48	5,3	856.230	3510785419845	25,85
PROFIL N°231	48	5,3	856.231	3510785419777	25,85
PROFIL N°232	48	5,3	856.232	3510785419302	25,85
PROFIL N°233	48	5,3	856.233	3510785419913	25,85
PROFIL N°235	48	5,3	856.235	3510785420018	25,85
PROFIL N°236	48	5,3	856.236	3510785420391	25,85
PROFIL N°237	48	5,3	856.237	3510785420506	25,85
PROFIL N°238	48	5,3	856.238	3510785419531	25,85
PROFIL N°239	48	5,3	856.239	3510785419753	25,85
PROFIL N°240	48	5,3	856.240	3510785420162	25,85
PROFIL N°241	48	5,3	856.241	3510785420353	25,85
PROFIL N°242	48	5,3	856.242	3510785419692	25,85
PROFIL N°243	48	5,3	856.243	3510785420049	25,85
PROFIL N°244	48	5,3	856.244	3510785420360	25,85
PROFIL N°245	48	5,3	856.245	3510785420124	25,85
PROFIL N°246	48	5,3	856.246	3510785420155	25,85
PROFIL N°247	48	5,3	856.247	3510785419852	25,85
PROFIL N°248	48	5,3	856.248	3510785419999	25,85
PROFIL N°250	48	5,3	856.250	3510785419906	25,85
PROFIL N°251	48	5,3	856.251	3510785419821	25,85
PROFIL N°252	48	5,3	856.252	3510785420292	25,85
PROFIL N°253	48	5,3	856.253	3510785420230	25,85
PROFIL N°254	48	5,3	856.254	3510785420063	25,85
PROFIL N°255	48	5,3	856.255	3510785420315	25,85
PROFIL N°258	48	5,3	856.258	3510785419968	25,85
PROFIL N°259	48	5,3	856.259	3510785420032	25,85
PROFIL N°260	48	5,3	856.260	3510785420629	25,85
PROFIL N°272	48	5,3	856.272	3510785419814	25,85
PROFIL N°273	48	5,3	856.273	3510785420438	25,85
PROFIL N°274	48	5,3	856.274	3510785420483	25,85

ALE.00955

JEU DE 2 FERS PROFILÉS HT 90 MM

N°090



N°134

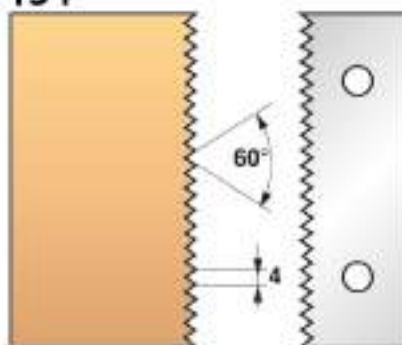

N°302

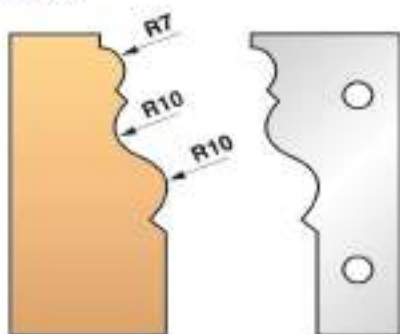

N°303

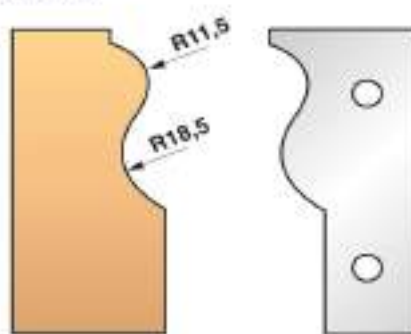

N°304

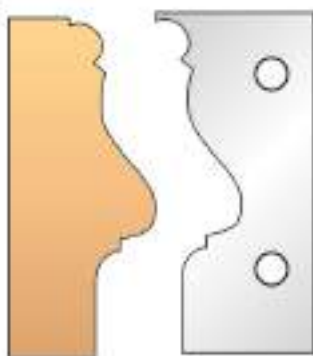

N°305

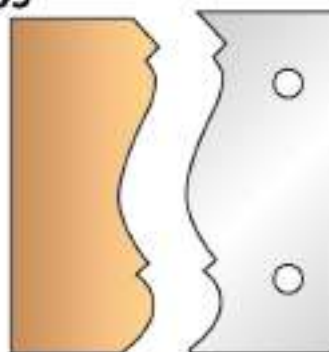

N°305

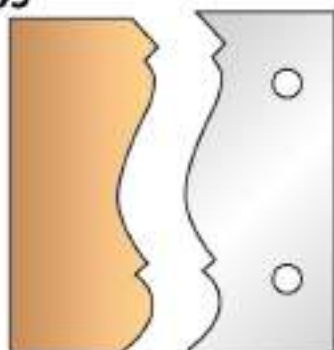

N°322

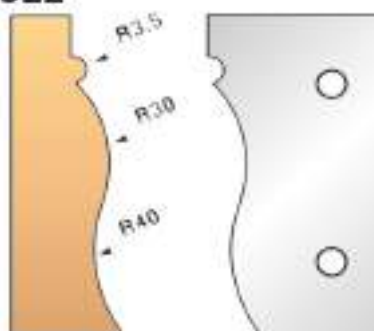

BOIS MASSIF

ALE.00955

JEU DE 2 FERS PROFILÉS HT 90 MM

N°323

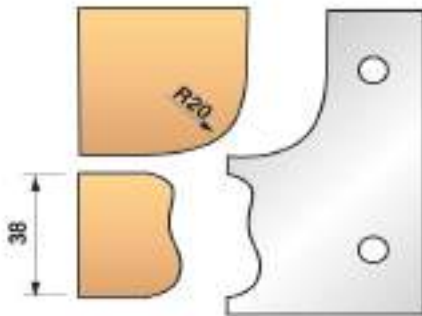

N°325

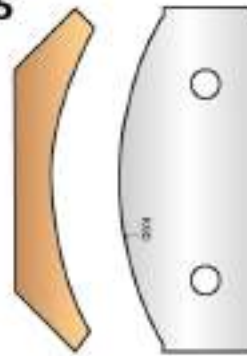

N°351

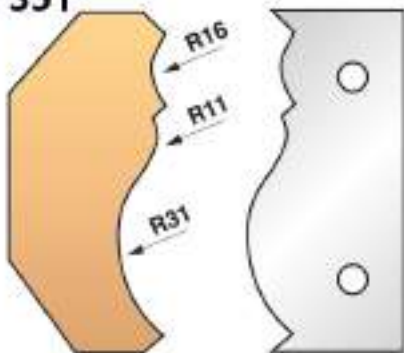

N°352

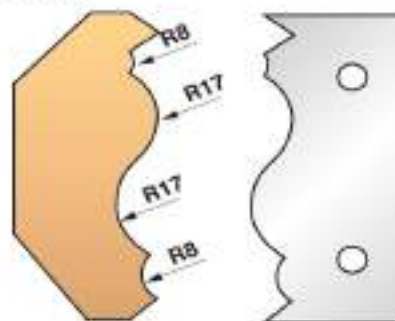

N°353

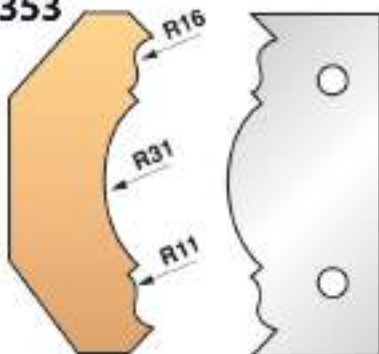

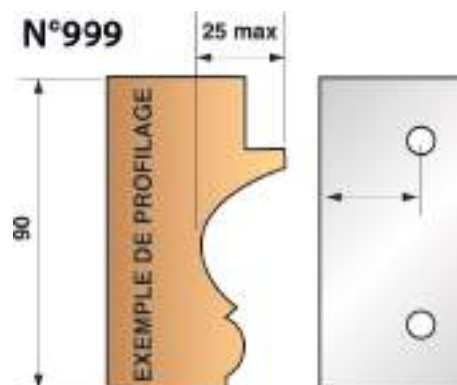

N°999



CLASSIC

ALE.00955



JEU DE 2 FERS HAUTEUR 90 MM

			REF		€
PROFIL N°90	90	5,5	955.090	3510789550902	57,39
PROFIL N°134	90	5,5	955.134	3510789551343	57,39
PROFIL N°301	90	5,5	955.301	3510789553019	57,39
PROFIL N°302	90	5,5	955.302	3510789553026	57,39
PROFIL N°303	90	5,5	955.303	3510789553033	57,39
PROFIL N°304	90	5,5	955.304	3510789553040	57,39
PROFIL N°305	90	5,5	955.305	3510789553057	57,39
PROFIL N°322	90	5,5	955.322	3510789553224	57,39
PROFIL N°323	90	5,5	955.323	3510789553231	57,39
PROFIL N°325	90	5,5	955.325	3510785434565	57,39
PROFIL N°351	90	5,5	955.351	3510789553514	57,39
PROFIL N°352	90	5,5	955.352	3510789553521	57,39
PROFIL N°353	90	5,5	955.353	3510789553538	57,39

CLASSIC

ALE.955H90.AP

JEU DE 2 FERS À PROFILER HAUTEUR 90 MM

			REF		€
	90	5,5	955.299	3510789552999	51,64
		30	955.999	PROFILAGE SPÉCIAL	sur devis

PANNEAUX ET DÉRIVÉS DU BOIS



HM
PLAQUETTES

EN847-1

ALE.00092

PORTE-OUTILS À PROFILER ET À FEILLURER - HT 40 MM

- Feuillurage et profilage de bois massifs, lamifiés, agglomérés.
- Possibilité de montage de tous les fers profilés en hauteur 40 mm.
- Possibilité de montage en bout d'arbre.
- Livré équipé.

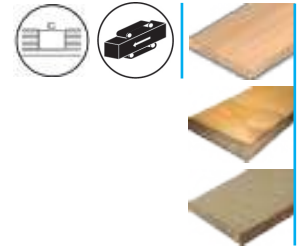

BOIS, BOIS LATTÉ, AGGLOMÉRÉ

RECHANGE : PLAQUETTE (40 x 12 x 1,5) 0040.1215.00 - ARASEUR (14 x 14 x 2) 0014.1420.00.

Ø	⊕		Z	REF	REF	€
90	30	40	2+V2	092.40.30	3510780924030	133,40
120	50	40	2+V2	122.40.50	3510781224054	179,30



HM
PLAQUETTES

EN847-1

ALE.00093

PORTE-OUTILS À PROFILER ET À FEILLURER - HT 50 MM

- Feuillurage et profilage de bois massifs et lamifiés.
- Possibilité de montage de tous les fers profilés en hauteur 40 et 50 mm.
- Possibilité de montage en bout d'arbre.
- Livré équipé.

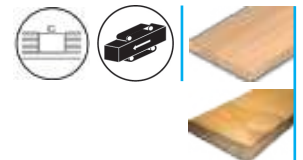

BOIS, BOIS LATTÉ

RECHANGE : PLAQUETTE (50 x 12 x 1,5) 0050.1215.00 - ARASEUR (14 x 14 x 2) 0014.1420.00.

Ø	⊕		Z	REF	REF	€
100	30	50	2+V2	093.50.30	3510780935036	114,76

PANNEAUX ET DÉRIVÉS DU BOIS



HM
PLAQUETTES

EN847-1

ALE.00123

PORTE-OUTILS À PROFILER ET À FEUILLURER - HT 50 MM

- Feuillurage et profilage de bois massifs et lamifés.
- Possibilité de montage de tous les fers profilés en hauteur 40 et 50 mm.
- Livré équipé.

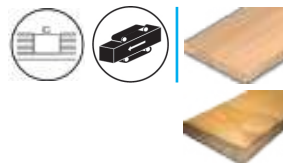

BOIS, BOIS LATTÉ

RECHANGE : PLAQUETTE (50 x 12 x 1,5) 0050.1215.00 - ARASEUR (14 x 14 x 2) 0014.1420.00.

Ø	⊙		Z	REF	REF	€
120	50	50	2+V2	123.50.50	3510781235050	172,08



HM
PLAQUETTES

EN847-1

ALE.00106

PORTE-OUTILS À PROFILER ET À FEUILLURER DOUBLE ENTRAXE - HT 50 MM

- Porte-outils entraxe de 24 et 30 mm pour fers profilés.
- Feuillurage, profilage et moulurage sur bois massif.
- Changement simultané des 2 fers portant la même référence.
- Possibilité de montage en bout d'arbre.
- Livré équipé.



BOIS

RECHANGE : PLAQUETTES (50 x 12 x 1,5) 0050.1215.00 - ARASEUR (14 x 14 x 2) 0014.1420.00.

Ø	⊙		Z	REF	REF	€
100	30	50	(2+) 2+V2	106.50.30	3510785419050	137,88
120	50	50	(2+) 2+V2	126.50.50	3510785419081	178,85

PANNEAUX ET DÉRIVÉS DU BOIS

CLASSIC



EN847-1

ALE.00093.CO

COFFRET PORTE-OUTILS À PROFILER - HT 50 MM



Composition du coffret:

x6 : 203-220-239-275-286-207

x12 : 204-206-212-225-229-248

x24 : 231-232-260-277-279-280-274-210-236-244-254-255

MDF/HDF, STRATIFIÉ, MÉLAMINÉ

		REF		€
50	2+V2	093.50.30.06	3510780935067	272,47
50	2+V2	093.50.30.12	3661589037480	413,03
50	2+V2	093.50.30.24	3661589037497	682,66

CLASSIC



EN847-1

ALE.00123.CO

COFFRET PORTE-OUTILS À PROFILER - HT 50 MM



Composition du coffret:

x6 : 203-220-239-275-286-207

x12 : 204-206-212-225-229-248

x24 : 231-232-260-277-279-280-274-210-236-244-254-255

MDF/HDF, STRATIFIÉ, MÉLAMINÉ

		REF		€
50	2+V2	123.50.50.06	3661589036001	301,16
50	2+V2	123.50.50.12	3661589037503	441,71
50	2+V2	123.50.50.24	3661589037862	711,34

CLASSIC



ALE.00937

PORTE-OUTILS À RAINER

- Porte-outils extensible.
- Ajout possible d'un porte-outils intermédiaire pour feuillurage jusqu'à 19,5 mm.
- Porte-outils Ø 150 mm cumulable avec Porte-outils profils / contre-profils.



HM

PLAQUETTES

EN847-1

BOIS, MDF/HDF, STRATIFIÉ, MÉLAMINÉ

RECHANGES ET ACCESSOIRES ALE.00937

Description	Ø	Ø	Ø	Ø	Z	REF		€
	120	30	4-7,5	25	4+V4	937.120.30.0408	3510789371231	280,98
	120	30	5-9,5	25	4+V4	937.120.30.0595	3510785419166	257,59
	150	30	5-9,5	25	4+V4	937.150.30.0510	3510789371507	272,47
	150	30	8-15,5	25	4+V4	937.150.30.0815	3510789371514	324,17
PORTE-OUTILS INTERMÉDIAIRE	120	30	8	25	2	937.120.30.0008	3661589038180	178,80
PORTE-OUTILS INTERMÉDIAIRE	150	30	10	25	2	937.150.30.0010	3510789371521	170,04

ACCESSOIRES

CLASSIC

ALE.ACC.970
GUIDES À BILLES

Description				REF		€
ROULEMENT	55	30	13	970.5.055.30.00	3510789005013	20,11
BAGUE	80	55	15	970.5.080.55.00	3510789005037	41,65
BAGUE	90	55	15	970.5.090.55.00	3510789005044	43,06
BAGUE	100	55	15	970.5.100.55.00	3510789005020	43,06
BAGUE	110	55	15	970.5.110.55.00	3510789005051	43,06
BAGUE	120	55	15	970.5.120.55.00	3510789005068	43,06
BAGUE	125	55	15	970.5.125.55.00	3510789005075	43,06
BAGUE	140	55	15	970.5.140.55.00	3510789005082	43,06

CLASSIC

ALE.ACC.970.06
COFFRET 5 BAGUES ET ROULEMENT

1 roulement à billes Ø55, AL30 mm.
 1x bague Ø80, 90, 100, 120, 125 mm.



REF		€
970.5.000.00.01	3661589037442	179,30

ACCESSOIRES

CLASSIC





ALE.ACC.969

MANCHON ET VIS BOUT D'ARBRE



Réf. 969.5.040.30.14 pour porte-outils avec lamage 40x6 mm, pour outils en alésage 30 avec dégagement.

Description			REF		€
MANCHON + VIS BTR M14 X 200	30	18	969.5.040.30.14	3510789690141	27,27
MANCHON + VIS BTN M16 X 200	50	18	969.5.070.5016	3510785408986	27,27
MANCHON + VIS BTN M16 X 200	30	18	969.5.040.30.16	3661589043467	27,27





CLASSIC



ALE.ACC.968

MANCHON DE REDUCTION



Description				REF		€
MANCHON	50	30	80	969.5.050.30.80	3510789690011	166,34
MANCHON	50	30	100	969.5.050.30.10	3510789690028	206,51
MANCHON	50	30	130	969.5.050.30.13	3510789690035	250,99





CLASSIC



ALE.ACC.968C

BAGUE CHAPEAU



Description				REF		€
CHAPEAU 2 PIÈCES	50	30		968.5.050.30.00	3510789685307	30,11
VIS M14 - PAS 200			80	968.5.014.20.80	3510785419357	25,85
VIS M16 - PAS 200			100	968.5.016.20.10	3510785418985	22,79

ACCESSOIRES

CLASSIC

ALE.ACC.963
JEU DE 2 BAGUES DE RÉDUCTION

			REF		€
30	20	20	963.5.030.20.20	3510785419210	26,59
40	30	20	963.5.040.30.20	3510789635401	26,59
50	30	20	963.5.050.30.20	3510789635302	26,59

CLASSIC

ALE.ACC.150
SAUTERELLES

Description	REF		€
	150.000.H	3510781500004	24,38
SAUTERELLE HORIZONTALE 70x100x55 grand modele	250.000.H	3510782500003	27,27
SAUTERELLE VERTICALE 50x60x34 petit modele	150.000.V	3661589034571	24,38
SAUTERELLE VERTICALE 50x100x42 grand modele	250.000.V	3510782500010	27,27

ACCESSOIRES



ALE.ACC.964.00

JEU DE 10 BAGUES MILLIMÉTRIQUES DE 1 À 10/10 MM



		REF		€
45	30	964.5.045.30.00	3510789645301	18,70



ALE.ACC.964.01

JEU DE 10 BAGUES MILLIMÉTRIQUES DE 1 À 10 MM



		REF		€
45	30	964.5.045.30.01	3510789645318	63,13



ALE.ACC.966.10

JEU DE 10 BAGUES DE REMPLISSAGE



			REF		€
45	30	130	966.5.045.30.00	3510789665309	80,34



ALE.ACC.966.12

JEU DE 12 BAGUES DE REMPLISSAGE



			REF		€
45	30	205	966.5.045.30.01	3510789665316	110,51

ACCESSOIRES

CLASSIC

ALE.RECH

PIECES DE RECHANGE - SAV



Description	REF		€
COIN DE SERRAGE HT.40mm	26501	3510785420490	11,42
COIN DE SERRAGE HT.50mm.	26501.50	3510785419326	15,97
COIN DE SERRAGE HT.90mm	26501.90	3510785413317	19,49
SUPPORT DE PLAQUETTE HT.40mm	26502	3510785420261	17,73
SUPPORT DE PLAQUETTE HT.50mm	26505	3510785419524	18,98
VIS TF M5x8 FENDUE POUR ARASEURS	VISARASEUR	3510785430666	1,20
VIS TF TORX T25 M5x8	G32.05.006.25	3510785428007	1,42
VIS DE CENTRAGE HT.40/50/90	VIS.SINEAU	3510785430604	3,02
GOUJON FILETÉ M8x20 DIN915 HT.40/50/90	G31.08.020.07	3510785427918	2,27

CLASSIC



ALE.00937.ACC

PIECES DE RECHANGE ALE.00937

Description	REF		€
VIS TF M4x3,2	VIS937.601	3510785430628	5,12
VIS TF M4x4	937.510.VIS	3661589073570	4,55
ECROU M4 9,8x2,15	ECR937.652	3510785430567	2,99
ECROU M4 11,8x2,3	ECR937.657	3510785430574	2,39
ECROU M4 10x1,65	937.510.ECRA	3661589073648	4,55
ECROU M4 12x2,2	937.510.ECRC	3661589073587	4,55

CLASSIC



ALE.AJ928.ACC

PIECES DE RECHANGE ALE.AJ928

Description	REF		€
VIS TB M4x8	VIS928	3510785430611	2,27



info@leman-sa.com

FERS ET PLAQUETTES

BOIS MASSIF

FERS

P. 288

PLAQUETTES

P. 297

PANNEAUX ET DÉRIVÉS DU BOIS

PLAQUETTES

P. 295

EXPERT  pour les travaux spécialisés et de haute technicité.

CLASSIC  pour les travaux courants et polyvalents.

BOIS MASSIF

EXPERT



FPL.00145

FERS RÉVERSIBLES HSS POUR SYSTÈME TERSA



BOIS

				REF		€
10	115	2,3	2	145.511.50	3510785415236	9,79
10	120	2,3	2	145.512.00	3510785415243	9,97
10	130	2,3	2	145.513.00	3510785415250	10,67
10	160	2,3	2	145.516.00	3510785415274	12,88
10	180	2,3	2	145.518.00	3510785415281	13,85
10	230	2,3	2	145.523.00	3510785415328	16,56
10	240	2,3	2	145.524.00	3510785415335	17,10
10	260	2,3	2	145.526.00	3510785415342	17,80
10	300	2,3	2	145.530.00	3510785415359	20,35
10	310	2,3	2	145.531.00	3510785415366	20,99
10	400	2,3	2	145.540.00	3510785415373	25,38
10	410	2,3	2	145.541.00	3510785415380	26,08
10	500	2,3	2	145.550.00	3510785417759	32,42
10	510	2,3	2	145.551.00	3510785417261	33,07
10	520	2,3	2	145.552.00	3510785415397	33,71
10	610	2,3	2	145.561.00	3510785415403	38,74
10	630	2,3	2	145.563.00	3510785415410	40,05
10	640	2,3	2	145.564.00	3510785415427	41,61

Fers au carbure et autres dimensions sur commande.

BOIS MASSIF

EXPERT 







HSS

FPL.00147

FERS RÉVERSIBLES HSS BLACK OXIDE POUR
SYSTÈME CENTROFIX/CENTROSTAR/WIGO



BOIS

				REF		€
12	260	2,7	2	147.526.00	3661589035585	29,60
12	310	2,7	2	147.531.00	3661589035592	30,63
12	360	2,7	2	147.536.00	3661589076281	34,86
12	410	2,7	2	147.541.00	3661589035608	40,52

Fers au carbure et autres dimensions sur commande.

EXPERT 







HSS
18%

FPL.00143

FERS RÉVERSIBLES HSS 18% POUR
SYSTÈME CENTROLOCK



BOIS

				REF		€
16	100	3	2	143.510.00	3510785435081	18,83
16	120	3	2	143.512.00	3510785435098	19,43
16	130	3	2	143.513.00	3510785435104	19,91
16	150	3	2	143.515.00	3661589043061	23,00
16	180	3	2	143.518.00	3510785435111	27,54
16	190	3	2	143.519.00	3510785435128	29,00
16	230	3	2	143.523.00	3510785435135	35,18
16	240	3	2	143.524.00	3661589035790	36,48

Fers au carbure et autres dimensions sur commande.

BOIS MASSIF

EXPERT







HSS
18%

FPL.00146

**FERS RÉVERSIBLES HSS 18% POUR
SYSTÈME TERMINUS**



BOIS

				REF		€
14	300	2,55	2	146.530.00	3510785425594	43,34
14	310	2,55	2	146.531.00	3661589081551	39,97
14	400	2,55	2	146.540.00	3510785425600	51,35
14	510	2,55	2	146.551.00	3510785425624	62,55
14	610	2,55	2	146.561.00	3661589081568	78,55

Fers au carbure et autres dimensions sur commande.

EXPERT



HSS





FPL.06506

FERS BRUTS CRANTÉS

- Pour porte-outils à profil et hydro.
- Système EURO, crantage 60° au dos.



BOIS

				REF		€
40	650	8	1	6506.40	3510785417353	134,14
50	650	8	1	6506.50	3510785417391	144,47
60	650	8	1	6506.60	3510785417193	154,74
70	650	8	1	6506.70	3510785417384	165,09

BOIS MASSIF

EXPERT



HM





FPL.00157

FERS DE DÉGAUCHISSEUSE CARBURE





- Plaquette rapportée de 6,5 mm sur largeur 20mm et 10,5 mm sur largeurs supérieures.
- Réaffûtable.
- Livré en étui plastique.



BOIS

				REF		€
30	130	3	1	013.30.307	3510785417551	34,20
25	136	2,5	1	136.25.257	3510785418046	35,77
20	150	2,5	1	015.20.257	3510785418237	39,39
30	180	3	1	018.30.307	3510785418015	47,30
25	186	2,5	1	186.25.257	3661589078179	49,87
25	190	3	1	019.25.307	3510785417995	50,00
20	200	2,5	1	020.20.257	3510785417599	52,28
20	210	2,5	1	021.20.257	3510785417766	55,24
30	230	3	1	023.30.307	3510785417360	60,50
20	260	2,5	1	026.20.257	3510785417254	68,34
20	260	3	1	026.20.307	3510785417452	68,34
25	260	3	1	026.25.307	3510785417803	68,34
30	260	3	1	026.30.307	3510785418336	68,34
20	310	2,5	1	031.20.257	3510785417247	81,49
25	310	3	1	031.25.307	3510785417421	81,49
30	310	3	1	031.30.307	3510785417926	81,49
30	330	3	1	033.30.307	3510785417889	91,93
30	350	3	1	035.30.307	3510785418565	91,93
25	360	2,5	1	036.25.257	3510785418435	94,64
30	400	3	1	040.30.307	3510785417568	105,08
25	410	2,5	1	041.25.257	3510785418176	107,73
25	410	3	1	041.25.307	3510785417650	107,73
30	410	3	1	041.30.307	3510785417124	107,73

BOIS MASSIF

					REF		€
	30	420	3	1	042.30.307	3510785418268	110,27
	30	500	3	1	050.30.307	3510785417506	131,31
	25	510	2,5	1	051.25.257	3510785418077	134,03
	25	510	3	1	051.25.307	3510785417827	134,03
	30	510	3	1	051.30.307	3510785417131	134,03
	35	510	3	1	051.35.307	3510785417742	134,03
	30	520	3	1	052.30.307	3510785417476	136,73
	35	520	3	1	052.35.307	3510785417537	136,73
	30	530	3	1	053.30.307	3510785417698	139,22
	30	610	3	1	061.30.307	3510785417407	160,26
	30	630	3	1	063.30.307	3510785417346	165,52
	30	640	3	1	064.30.307	3510785417667	168,22
	30	710	3	1	071.30.307	3510785418572	186,51
COUPE					30.COUPE	3510785436200	10,44
BARRE DE FER	25	1000	3	1	100.25.307	3510785417469	234,47
BARRE DE FER	30	1000	3	1	100.30.307	3510785417322	234,47

Coupe possible pour dimensions intermédiaires.

EXPERT





FPL.00380

JEU DE 2 POSITIONNEURS MAGNÉTIQUES DE FERS



- Réglage des couteaux sur les porte-outils en acier.

		REF		€
Ø 56	2	380.700.056	3510785434077	64,93
Ø 60	2	380.700.060	3510785434084	64,93
Ø 63	2	380.700.063	3510785434701	64,93
Ø 70	2	380.700.070	3510785434091	64,93
Ø 75	2	380.700.075	3510785434695	64,93
Ø 86	2	380.700.086	3510785434107	64,93
Ø 96	2	380.700.096	3510785434114	64,93
Ø 100	2	380.700.100	3510785434121	64,93
Ø 120	2	380.700.120	3510785434138	64,93
Ø 125	2	380.700.125	3510785434145	64,93

BOIS MASSIF

CLASSIC



HSS
18%

FPL.00243

FERS DE DÉGAUCHISSEUSE HSS 18%

- Convient particulièrement pour le bois nouveau.
- Livré en étui plastique.



BOIS

				REF		€
30	120	3	1	012.30.302	3510785418404	8,70
30	130	3	1	013.30.302	3510785417773	9,41
25	136	3	1	136.25.302	3510785418329	9,86
20	150	2,5	1	015.20.252	3510781301021	10,77
30	150	3	1	015.30.302	3510781301038	10,77
25	186	3	1	186.25.302	3510785418527	13,49
20	200	2,5	1	020.20.252	3510781301052	14,50
20	210	2,5	1	021.20.252	3510781301076	15,31
30	210	3	1	021.30.302	3510781301090	16,67
25	230	2,5	1	023.25.252	3510785418589	16,67
25	230	3	1	023.25.302	3510785417964	16,67
30	230	3	1	023.30.302	3510785417445	16,67
30	240	3	1	024.30.302	3510785417711	17,40
30	250	3	1	025.30.302	3510785417339	18,88
20	260	2,5	1	026.20.252	3510781301106	18,88
20	260	3	1	026.20.302	3510781301113	18,88
25	260	2,5	1	026.25.252	3510781301120	18,88
25	260	3	1	026.25.302	3510781301137	18,88
30	260	3	1	026.30.302	3510781301144	18,88
20	300	3	1	030.20.302	3510785417216	21,76
30	300	3	1	030.30.302	3510781301151	21,76
20	310	2,5	1	031.20.252	3510781301168	22,40
20	310	3	1	031.20.302	3510785417780	22,40
25	310	2,5	1	031.25.252	3510785417513	22,40
25	310	3	1	031.25.302	3510781301175	22,40
30	310	3	1	031.30.302	3510781301182	22,40
30	320	3	1	032.30.302	3510781301199	23,21
30	330	3	1	033.30.302	3510785417902	23,94
30	350	3	1	035.30.302	3510781301205	25,21
25	360	2,5	1	036.25.252	3510781301212	26,10

BOIS MASSIF

					REF		€
	25	400	3	1	040.25.302	3510785417582	29,00
	30	400	3	1	040.30.302	3510785417179	29,00
	20	410	3	1	041.20.302	3510785418220	29,65
	25	410	2,5	1	041.25.252	3510781301236	29,65
	25	410	3	1	041.25.302	3510781301243	29,65
	30	410	3	1	041.30.302	3510781301267	29,65
	35	410	3	1	041.35.302	3510781301274	29,65
	25	420	2,5	1	042.25.252	3510781301281	30,45
	25	420	3	1	042.25.302	3510781301298	30,45
	30	420	2,5	1	042.30.252	3510781301304	30,45
	30	420	3	1	042.30.302	3510781301311	30,45
	30	500	3	1	050.30.302	3510785417063	36,26
	35	500	3	1	050.35.302	3510785417483	36,25
	25	510	2,5	1	051.25.252	3510781301335	36,90
	25	510	3	1	051.25.302	3510781301342	36,90
	30	510	2,5	1	051.30.252	3510781301359	36,90
	30	510	3	1	051.30.302	3510781301366	36,90
	35	510	3	1	051.35.302	3510781301373	36,90
	30	520	3	1	052.30.302	3510781301410	37,77
	35	520	3	1	052.35.302	3510781301427	37,77
	30	530	3	1	053.30.302	3510781301465	38,26
	35	530	3	1	053.35.302	3510781301472	38,43
	30	600	3	1	060.30.302	3510781301489	43,50
	30	610	3	1	061.30.302	3510781301526	44,27
	35	610	3	1	061.35.302	3510781301533	44,24
	30	630	3	1	063.30.302	3510781301557	45,40
	35	630	3	1	063.35.302	3510785417377	45,69
	30	640	3	1	064.30.302	3510781301564	45,89
	35	640	3	1	064.35.302	3510785417414	46,40
	30	710	3	1	071.30.302	3510781301595	51,48
	35	710	3	1	071.35.302	3510781301601	51,48
	30	810	3	1	081.30.302	3510781301618	58,73
	COUPE				32.COUPE	3510785436194	5,90
BARRE DE FER	20	1000	2,5	1	100.20.252	3510785425273	58,95
BARRE DE FER	20	1000	3	1	100.20.302	3510785425280	58,95
BARRE DE FER	25	1000	2,5	1	100.25.252	3510785425297	58,95
BARRE DE FER	25	1000	3	1	100.25.302	3510785425303	58,95
BARRE DE FER	30	1000	3	1	100.30.302	3510785425327	58,95
BARRE DE FER	35	1000	3	1	100.35.302	3510785425334	58,95

Coupe possible pour dimensions intermédiaires.

PANNEAUX ET DÉRIVÉS DU BOIS

EXPERT



FPL.800TI

PLAQUETTES CARBURE REVÊTEMENT TITANE



BOIS, STRATIÉ, CONTREPLAQUÉ

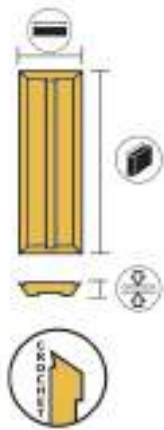

						REF		€
VERSOFIX	10	20	1,5	4	10	800.210.01	3510785417315	16,14
VERSOFIX	10	30	1,5	4	10	800.310.01	3510785417032	16,88
VERSOFIX	10	50	1,5	4	10	800.510.01	3510785417612	23,43
	5,5	20	1,1	4	10	800.205.51TIN	3510785435289	20,68
	10	30	1,5	4	10	800.301.01TIN	3510785425952	22,08

K01

TITANE

CLASSIC



FPL.00800

PLAQUETTES RÉVERSIBLES AU CARBURE



BOIS

						REF		€
	10	30	1,5	4	10	800.301.01	3510785418671	9,53

HM

PANNEAUX ET DÉRIVÉS DU BOIS

EXPERT 









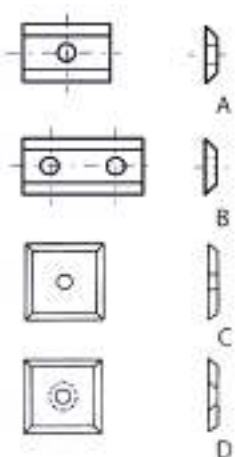

FPL.02.80.10

PLAQUETTES RÉVERSIBLES AU CARBURE 35° - SMG-02



MDF/HDF, STRATIFIÉ, MÉLAMINÉ



							REF		€	
A		12	9,6	1,5	2	10	02.8015.2	3510785401697	6,55	
A		12	15	1,5	2	10	02.8003.2	3510785401703	6,93	
A		12	20	1,5	2	10	02.8004.2	3510785401710	7,43	
B		12	30	1,5	2	10	02.8005.2	3510785401727	7,85	
B		12	40	1,5	2	10	02.8014.2	3510785401734	10,72	
B		12	50	1,5	2	10	02.8006.2	3510785401741	10,93	
C		12	12	1,5	4	10	02.8002.4	3510785401765	6,07	
D		6,8	14	14	2	4	10	02.8099.4	3510785401772	6,40

SMG-02

EXPERT 









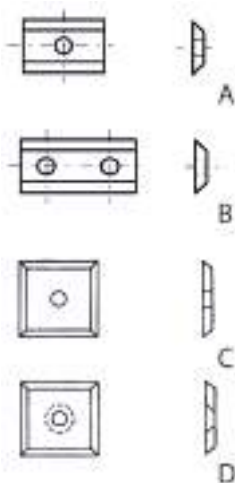

FPL.02.40.10

PLAQUETTES RÉVERSIBLES AU CARBURE 35° - K01



BOIS, MÉLAMINÉ



							REF		€	
A		12	7,5	1,5	2	10	02.4001.2	3510785424535	4,39	
A		12	9,6	1,5	2	10	02.4015.2	3510785424610	6,12	
A		12	15	1,5	2	10	02.4003.2	3510785424559	5,14	
A		12	20	1,5	2	10	02.4004.2	3510785424566	4,39	
B		12	25	1,5	2	10	02.4011.2	3510785417872	8,01	
B		12	30	1,5	2	10	02.4005.2	3510785424573	6,12	
B		12	40	1,5	2	10	02.4014.2	3510785424603	8,01	
B		12	50	1,5	2	10	02.4006.2	3510785424580	8,01	
B		12	60	1,5	2	10	02.4007.2	3510785424597	12,07	
C		12	12	1,5	4	10	02.4002.4	3510785424542	5,14	
D		6,8	14	14	2	4	10	02.4099.4	3510785417094	5,47

K01

BOIS MASSIF

CLASSIC



FPL.02.21.10

PLAQUETTES RÉVERSIBLES AU CARBURE - K05



BOIS

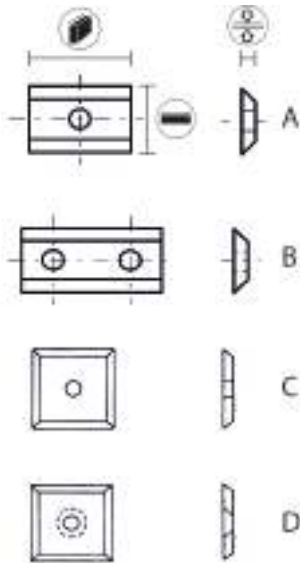

K05

							REF		€
A	12	7,5	1,5	2	10	0765.1215.00	3510785417292	3,91	
A	12	9	1,5	2	10	0090.1215.00	3510785418299	4,23	
A	12	9,6	1,5	2	10	0096.1215.00	3510785417209	4,23	
A	12	15	1,5	2	10	0015.1215.00	3510785417285	4,23	
A	12	20	1,5	2	10	0020.1215.00	3510785417056	4,23	
A	12	24,7	1,5	2	10	0025.1215.00	3510785417629	6,60	
B	12	25	1,5	2	10	0025.1215.01	3510785417575	7,20	
B	12	30	1,5	2	10	0030.1215.00	3510785417018	4,23	
B	12	40	1,5	2	10	0040.1215.00	3661589034168	5,64	
B	12	50	1,5	2	10	0050.1215.00	3510781501094	5,64	
B	12	60	1,5	2	10	0060.1215.00	3510785417544	9,74	
C	12	12	1,5	4	10	0012.1215.00	3510785417049	4,23	
D	6,8	14	14	2	4	10	0014.1420.00	3510781511154	4,23
C	17	17	2	4	10	02.2094.4	3510785417896	14,23	
C	OPPOLD	13	13	2,5	4	10	02.2192.4	3510785418008	10,67
C	13,6	13,6	2	4	10	02.2174.4	3510785418473	9,74	
C	8,5	14	14	1,2	4	10	02.2171.4	3510785417148	4,23
D	8,8/22°	14	14	1,7	4	10	02.2172.4	3510785417797	9,53
D	8,8/30°	14	14	1,7	4	10	02.2180.4	3510785417858	9,74
D	6,2	14,3	14,3	2,5	4	10	02.2196.4	3510785417070	8,66
D	14,5	14,5	2	4	10	02.2191.4	3510785417490	8,99	
D	6,2	15	15	2,5	4	10	02.2186.4	3510785417278	9,53

BOIS MASSIF

CLASSIC



FPL.18.18.10

PLAQUETTES RÉVERSIBLES AU CARBURE - K30



K30

BOIS

						REF		€
A	18	18	1,95	4	10	0018.1819.00	3510785417117	12,67
A	18	18	2,45	4	10	0018.1824.00	3510785417186	14,67
A	18	18	2,95	4	10	0018.1829.00	3510785417087	23,10
B	19	22	2	3	10	02.2098.4	3510785417223	15,21
C	14	14	2	4	10	F3.14.20.20	3510785417681	16,24

CLASSIC



FPL.30.10

**PLAQUETTES RÉVERSIBLES AU CARBURE
BIAIS 5° - K05**

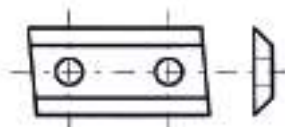
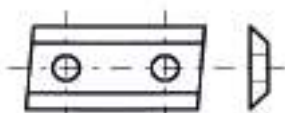

K05

BOIS

						REF		€
COUPE À DROITE	12	30	1,5	2	10	0030.1215.10	3510785417971	10,02
COUPE À GAUCHE	12	30	1,5	2	10	0030.1215.11	3510785418060	10,02

BOIS MASSIF

CLASSIC



FPL.02.56.10

PLAQUETTES RÉVERSIBLES AU CARBURE 45° - K050

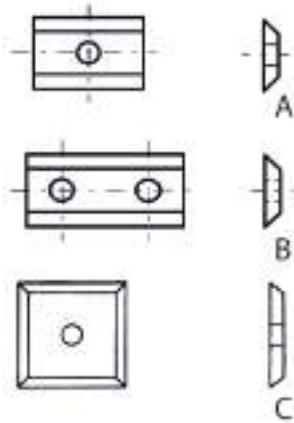

K050

BOIS

						REF		€
A	12	7,5	1,5	2	10	02.5601.2	3510785424627	4,99
A	12	20	1,5	2	10	02.5604.2	3510785424641	6,12
B	12	30	1,5	2	10	02.5605.2	3510785424658	6,60
B	12	40	1,5	2	10	02.5614.2	3510785424672	8,77
B	12	50	1,5	2	10	02.5606.2	3510785424665	8,77
C	12	12	1,5	4	10	02.5602.4	3510785424634	5,64

BOIS MASSIF

CLASSIC



FPL.02.25.10
PLAQUETTES RÉVERSIBLES AU CARBURE 35° - K05



BOIS

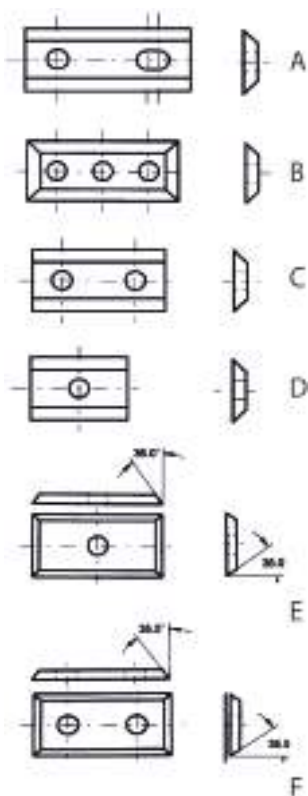

							REF		€
A	13	80	2,2	2	10	0080.1322.00	3510785417162	26,73	
A	13	100	2,2	2	10	0100.1322.00	3510785417636	37,56	
B	12	50	1,7	4	10	0050.1217.00	3510785417704	15,48	
OPPOLD	C	12	30	1,5	2	10	02.2432.2	3510785418244	10,02
OPPOLD	A	15	44,5	1,5	2	10	0445.1515.00	3510785418251	15,48
D	12	10	1,5	2	10	02.2016.2	3510785417933	14,08	
D	12	13,6	1,5	2	10	02.2028.2	3510785418596	14,56	
D	12	14,6	1,5	2	10	02.2029.2	3510785418190	13,64	
C	9	30	1,5	2	10	02.2038.2	3510785418084	9,09	
C	9	50	1,5	2	10	02.2040.2	3510785417940	11,59	
E	12	19,5	1,5	4	10	02.2526.4	3510785417438	9,53	
F	10	29,5	1,5	4	10	02.2534.4	3510785417674	11,59	
F	12	29,5	1,5	4	10	02.2536.4	3510785417155	9,74	
F	12	39,5	1,5	4	10	02.2546.4	3510785418121	11,90	
F	9	49,5	1,5	4	10	02.2553.4	3510785418411	14,56	
F	12	49,5	1,5	4	10	02.2556.4	3510785417230	12,07	

K05

BOIS MASSIF

CLASSIC



FPL.02.22.10
MINI PLAQUETTES CARBURE 35° RAINURÉE

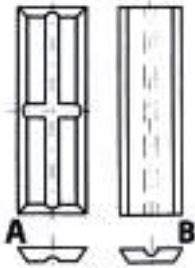

K05

BOIS									
							REF		€
PETITE FACE RAINURÉE	A	5,5	20	1,1	4	10	800.205.51	3510785418695	8,45
PETITE FACE RAINURÉE	A	5,5	25	1,1	4	10	02.2275.4	3510785418480	10,02
PETITE FACE RAINURÉE	A	5,5	30	1,1	4	10	02.2272.4	3510785417728	10,02
PETITE FACE RAINURÉE	A	5,5	50	1,1	4	10	02.2274.4	3510785417988	11,10
PETITE FACE RAINURÉE	A	4,1	20	1,1	4	10	02.2276.4	3510785418312	9,53
GRANDE FACE RAINURÉE	B	5,5	40	1,1	2	10	02.2203.2	3510785418053	5,47

CLASSIC



FPL.22.54.10
MINI PLAQUETTES CARBURE 40° RAINURÉE SUR GRANDE FACE

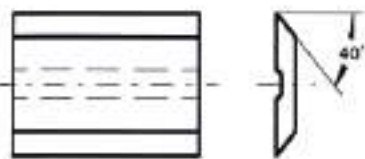

K05

BOIS									
							REF		€
8	7,7	1,5	2	10	02.5452.2	3510785418428	7,53		
8	19,7	1,5	2	10	02.5455.2	3510785417834	8,99		
8	30	1,5	2	10	02.5456.2	3510785417520	10,99		
8	50	1,5	2	10	02.5459.2	3510785417643	12,07		
8	60	1,5	2	10	02.5460.2	3510785418282	15,48		

BOIS MASSIF

CLASSIC



FPL.00140

JEU DE 2 FERS RÉAFFÛTABLES POUR RABOT PORTATIF



- 1 DN75-DN750
L1323
1901/1923B - 1001/1100
- 2 FP20-P205A
FU20
- 3 F30A
- 4 P60
- 5 1911B
- 6 1805B
1805N
- 7 1806B
- 9 L120N-L100
- 10 224-100

HSS

HM

BOIS

							REF		€
HSS	1	29	82	3	1	2	140.503.00	3510781405033	21,32
HM	1	29	82	3	1	2	140.703.00	3510781407037	38,42
HSS	2	28	82	3	1	2	140.511.00	3510781405118	49,79
HM	2	28	82	3	1	2	140.711.00	3510781407112	63,20
HSS	3	30	92	3	1	2	140.512.00	3510781405125	55,42
HM	3	30	92	3	1	2	140.712.00	3510781407129	75,97
HSS	4	28	168	3	1	2	140.542.00	3510781405422	121,42
HSS	5	29	110	3	1	2	140.526.00	3510781405262	71,32
HSS	6	32	155	3	1	2	140.527.00	3510781405279	69,48
HSS	7	35	170	3	1	2	140.528.00	3510781405286	87,87
HSS	9	29	92	3	1	2	140.540.00	3510781405408	76,73
HSS	10	25	78	3	1	2	140.541.00	3510781405415	42,96
HM	10	25	78	3	1	2	140.741.00	3510781407419	72,51

CLASSIC



FPL.00141

ADAPTATEURS POUR RABOT PORTATIF AVEC FERS



		REF		€
82	2	141.782.01	3510781417838	36,15

Jeu de 2 adaptateurs livré avec 2 fers réversibles au carbure.

HM

BOIS MASSIF

EXPERT



FPL.142.10
FERS DE RABOT RÉVERSIBLES



K30

BOIS, STRATIFIÉ, CONTREPLAQUÉ

				REF		€
5,5	75	1,1	10	142.775.10	3510781428759	43,29
5,5	78	1,1	10	142.778.10	3510781428780	43,29
5,5	80	1,1	10	142.780.10	3510781428803	41,88
5,9	80	1,1	10	142.781.10	3510781428810	43,29
5,5	82	1,1	10	142.782.10	3510781428827	43,29

CLASSIC



FPL.7142.10
10 FERS DE RABOT RÉVERSIBLES



K05

BOIS

				REF		€
5,5	78	1,1	10	7142.778.10	3661589032171	35,71
5,5	80	1,1	10	7142.780.10	3661589032164	35,71
5,5	82	1,1	10	7142.782.10	3661589032157	35,71

BOIS MASSIF



K05

FPL.242.10
10 FERS DE RABOT RÉVERSIBLES



BOIS

				REF		€
5,5	82	1,1	10	142.782.11	3510781429824	37,88
5,5	102	1,1	10	142.702.11	3510781429022	141,61



K05

FPL.242.02
2 FERS DE RABOT RÉVERSIBLES



BOIS

				REF		€
5,5	75	1,1	2	142.775.02	3510781427752	9,53
5,5	78	1,1	2	142.778.02	3510781427783	9,53
5,5	80	1,1	2	142.780.02	3510781427806	9,53
5,9	80	1,2	2	142.781.02	3510781427813	9,53
5,5	82	1,1	2	142.782.02	3510781427820	9,53





info@leman-sa.com

MORTAISAGE

INFOS TECHNIQUES

P. 308



BOIS MASSIF

P. 310

EXPERT  pour les travaux spécialisés et de haute technicité.

CLASSIC  pour les travaux courants et polyvalents.

GÉNÉRALITÉS

Une chaîne à mortaiser est définie par les paramètres suivants :

= Épaisseur

= Longueur

= Profondeur

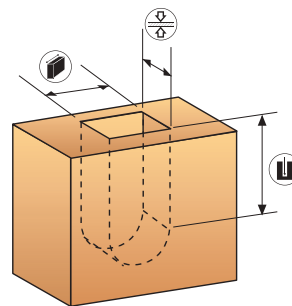

STANDARD FRANÇAIS

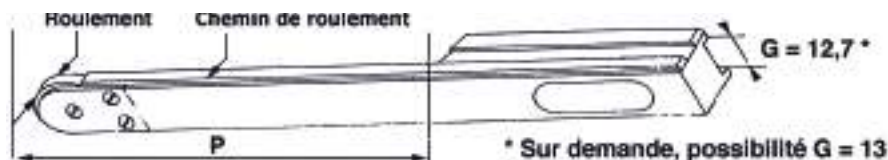

Le choix du guide est fonction de l'épaisseur de la chaîne (E), de la longueur (L) et de la profondeur (P) de la mortaise.

Le guide, suivant le chemin de roulement, peut être commun à plusieurs épaisseurs de chaînes.

L'entraxe E le plus répandu mesure 150 mm (axe pignon / axe vis serrage du guide).

Au chemin de roulement du guide correspond le maillon central (MC) sur la chaîne.

La décomposition se fait comme suit :

MC = 2,5 mm	Rlt = 2,5 mm, chaîne de 6 et 7 mm, pignon alésage 16 mm à 1 rangée de dents.
MC = 4,0 mm	Rlt = 4,0 mm, chaîne de 8 à 12 mm, pignon alésage 16 mm à 1 rangée de dents.
MC = 3x3 mm	Rlt = 9,0 mm, chaîne de 13 à 20 mm, pignon alésage 16 mm à 2 rangées de dents.
MC = 3x4,5 mm	Rlt = 13,5 mm, chaîne de 22 à 25 mm, pignon alésage 16 mm à 2 rangées de dents.
MC = 5x4,5 mm	Rlt = 22,5 mm, chaîne de 30 mm, pignon alésage 16 mm à 3 rangées de dents.

NB : à chaque guide correspondent 1 pignon et 1 embout de rechange.

La chaîne : sa longueur est définie par le nombre de maillons.

Il existe 2 types de maillons : 22,6 mm = Pas A 15,8 mm = Pas B

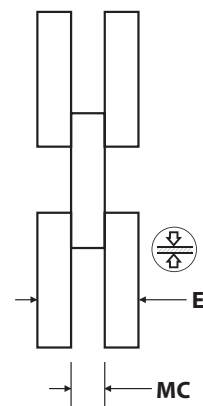

Cote intérieure
aux deux dents
extérieures

GARNITURES DOUBLES (SUR DEMANDE)

Les garnitures doubles sont utilisées pour exécuter deux mortaises parallèles, parfaitement symétriques, avec une distance constante l'une de l'autre, en une seule opération.

Elles sont composées de deux garnitures, construites pour fonctionner ensemble, et une entretoise (composée d'une plaquette et d'une bague) qui doit être montée entre les deux guides et les deux pignons pour obtenir la distance désirée entre les deux mortaises.

Dans les commandes: toujours préciser l'épaisseur des mortaises et la distance (épaisseur du bois) entre elles.

Par exemple : une garniture double 8 - 10 - 8 x 40 - A - CL.

L'entretoise aussi, doit être commandée en indiquant les trois numéros relatifs à l'épaisseur de la chaîne, l'épaisseur du bois.



CONSEILS D'UTILISATION

VITESSE MINIMUM DE COUPE ≈ 250 M / MIN
VITESSE POUR RENDEMENT MAXIMUM = 360 M / MIN

1- Ne pas trop tendre la chaîne; il faut qu'en la tirant de côté, à environ la moitié de sa longueur, il y ait un jeu de 6 à 8 mm. Contrôler la tension lorsque la chaîne est chaude après 10 mortaises environ.

2- Lubrifier la chaîne et le guide tous les quarts d'heure de travail avec quelques gouttes d'huile de viscosité moyenne, près du galet, ou visser le graisseur d'un demi-tour si la lubrification ne se fait pas par la pompe à huile automatique. (ne pas utiliser de pétrole, de gazoil, d'huiles trop fluides ou de lubrifiants à recycler).

3- Exécuter les mortaises par des mouvements doux et réguliers de façon à éviter les à-coups sur la chaîne surtout si le bois est dur et les chaînes petites.

4- Ne pas forcer le travail pour éviter de surchauffer le galet des guides et casser les chaînes.

5- Ne jamais travailler horizontalement sur grande hauteur.

6- Affûter souvent et légèrement la chaîne, en maintenant rigoureusement l'inclinaison de la dent et son profil primitif.

7- Lubrifier les chaînes et les guides avec de l'huile de viscosité moyenne dès retrait de la machine.

8- Les chaînes des pas "B" doivent être utilisées avec beaucoup de soin employant le double du temps nécessaire pour des mortaises de même largeur et de même profondeur exécutées avec le pas "A".

9- Un jeu excessif des galets et un affûtage négligé ou erroné des chaînes donnent des mortaises imparfaites et provoquent l'usure des outils.

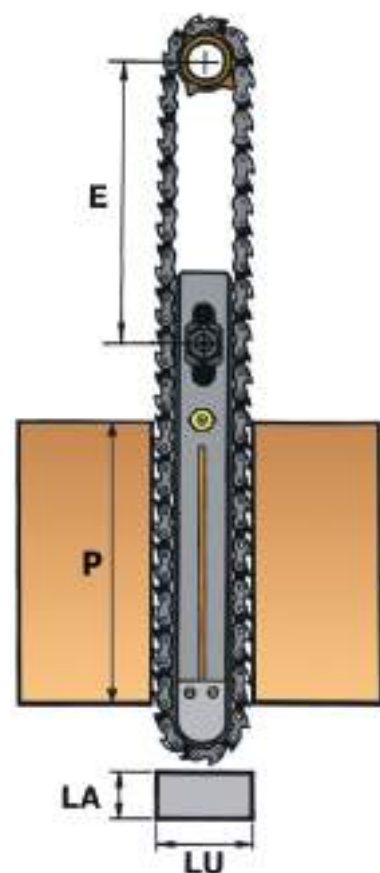

INSTRUCTIONS POUR UN BON USAGE DES CHÂÎNES

Effectuer fréquemment l'affûtage de la chaîne en conservant le profil de la coupe, comme illustré ci-contre. L'affûtage doit être réalisé seulement dans la partie frontale de la dent et jamais sur les côtés, pour ne pas en modifier la dimension.

Un affûtage correct et fréquent permet une plus longue conservation de la capacité de coupe de la chaîne et une moindre consommation du guide.



Affûtage des chaînes

BOIS MASSIF





EXPERT 



MOR.SF226.G

MORTAISAGE PAS A = 22,6 -
STANDARD FRANÇAIS - GUIDE



			MC(mm)	REF		€
150	40	6-7	2,5	22603.6740150	3510785424078	168,76
150	50	6-7	2,5	22603.6750150	3510785424085	168,00
150	40	8-12	4	22603.81240150	3510785422241	168,00
150	50	8-12	4	22603.81250150	3510785423002	176,40
150	40	13-20	9 (3x3)	22603.132040150	3510785422449	170,76
150	50	13-20	9 (3x3)	22603.132050150	3510785422937	195,78
150	40	22-25	13,5 (3x4,5)	22603.222540150	3510785422982	195,78
150	50	22-25	13,5 (3x4,5)	22603.222550150	3510785424054	218,73
150	40	30	22,5 (5x4,5)	22603.3040150	3510785424061	208,67
150	50	30	22,5 (5x4,5)	22603.3050150	3510785423200	217,99

RAINURE 12,7





EXPERT 



MOR.SF226.P

MORTAISAGE PAS A = 22,6 -
STANDARD FRANÇAIS - PIGNON



			MC(mm)	REF		€
150	40	6-7	2,5	22604.6740	3510785423606	21,38
150	50	6-7	2,5	22604.6750	3510785424108	24,62
150	40	8-12	4	22604.81240	3510785423040	21,38
150	50	8-12	4	22604.81250	3510785423378	24,62
150	40	13-20	9 (3x3)	22604.132040	3510785422845	24,62
150	50	13-20	9 (3x3)	22604.132050	3510785423415	29,55
150	40	22-25	13,5 (3x4,5)	22604.222540	3510785423569	27,92
150	50	22-25	13,5 (3x4,5)	22604.222550	3510785424092	31,16
150	40	30	22,5 (5x4,5)	22604.3040	3510785423477	29,55
150	50	30	22,5 (5x4,5)	22604.3050	3510785423439	34,41



ALÉSAGE 16.

Longueur de mortaise 40 mm : pignon 4 dents.

Longueur de mortaise 50 mm : pignon 5 dents.

BOIS MASSIF

EXPERT **MOR.SF226.C36****MORTAISAGE PAS A = 22,6 - STANDARD
FRANÇAIS - CHAÎNE 36 MAILLONS**

	MC(mm)	REF		€
6	2,5	22601.636	3510785423965	162,55
7	2,5	22601.736	3510785423613	162,55
8	4	22601.836	3510785422456	187,16
10	4	22601.1036	3510785422425	187,16
12	4	22601.1236	3510785422388	187,16
14	9 (3x3)	22601.1436	3510785423354	247,28
15	9 (3x3)	22601.1536	3510785422159	247,28
16	9 (3x3)	22601.1636	3510785422340	247,28
18	9 (3x3)	22601.1836	3510785422913	247,28
20	9 (3x3)	22601.2036	3510785422760	247,28
22	13,5 (3x4,5)	22601.2236	3510785423910	284,12
25	13,5 (3x4,5)	22601.2536	3510785423064	284,12
30	22,5 (5x4,5)	22601.3036	3510785422364	348,34

Chaînes d'épaisseur 9, 11, 13, 17 et 19 sur demande.

BOIS MASSIF





EXPERT



MOR.SF158.G

MORTAISAGE PAS B = 15,8 -
STANDARD FRANÇAIS - GUIDE



			MC(mm)	REF		€
110	25	6-7	2,5	15803.6725110	3510785422586	144,76
125	30	6-7	2,5	15803.6730110	3510785422128	144,76
125	35	6-7	2,5	15803.6735110	3510785422852	144,76
110	25	8-12	4	15803.81225110	3510785422661	144,76
125	30	8-12	4	15803.81230110	3510785421923	144,76
125	35	8-12	4	15803.81235110	3510785422173	144,76
110	25	13-20	9 (3x3)	15803.132025110	3510785422548	163,34
125	30	13-20	9 (3x3)	15803.132030110	3510785421961	163,34
125	35	13-20	9 (3x3)	15803.132035110	3510785422357	163,34
125	30	22-25	13,5 (3x4,5)	15803.222530110	3510785422470	175,86
125	30	30	22,5 (5x4,5)	15803.3030110	3510785422197	205,89
125	35	30	22,5 (5x4,5)	15803.3035110	3510785423286	205,89

RAINURE 12,7



EXPERT



MOR.SF158.P

MORTAISAGE PAS B = 15,8 -
STANDARD FRANÇAIS - PIGNON



		MC(mm)	REF		€
25/30/35	6-7	2,5	15804.6735	3510785422500	20,51
25/30	8-12	4	15804.81230	3510785422104	21,87
35	8-12	4	15804.81235	3510785423262	21,87
25/30	13-20	9 (3x3)	15804.132030	3510785422036	24,62
35	13-20	9 (3x3)	15804.132035	3510785422593	24,62
30	22-25	13,5 (3x4,5)	15804.222530	3510785422739	28,04
30/35	30	22,5 (5x4,5)	15804.3035	3510785422272	31,44

ALÉSAGE 16.

Longueur de mortaise 25 ou 30 mm : pignon 5 dents.

Longueur de mortaise 35 mm : pignon 6 dents.

BOIS MASSIF



EXPERT 



MOR.SF158.C48

MORTAISAGE PAS B = 15,8 - STANDARD FRANÇAIS -
CHAÎNE 48 MAILLONS



	MC(mm)	REF		€
6	2,5	15801.648	3510785422180	185,59
7	2,5	15801.748	3510785422975	185,59
8	4	15801.848	3510785421954	226,77
10	4	15801.1048	3510785421916	226,77
12	4	15801.1248	3510785421930	226,77
14	9 (3x3)	15801.1448	3510785422081	251,33
15	9 (3x3)	15801.1548	3510785421947	251,33
16	9 (3x3)	15801.1648	3510785421978	251,33
18	9 (3x3)	15801.1848	3510785422111	251,33
20	9 (3x3)	15801.2048	3510785422005	251,33
22	13,5 (3x4,5)	15801.2248	3510785422487	289,58
25	13,5 (3x4,5)	15801.2548	3510785422432	289,58
30	22,5 (5x4,5)	15801.3048	3510785421985	371,55

Chaînes d'épaisseur 9, 11, 13, 17 et 19 sur demande.



EXPERT 



MOR.SF158.C48CHR

MORTAISAGE PAS B = 15,8 - STANDARD FRANÇAIS -
CHAÎNE 48 MAILLONS CHROMÉE



	MC(mm)	REF		€
6	2,5	15801.648CHR	3510785432325	260,74
8	4	15801.848CHR	3510785432332	301,92
10	4	15801.1048CHR	3510785432127	301,92
12	4	15801.1248CHR	3510785432141	301,92
14	9 (3x3)	15801.1448CHR	3510785432165	326,48
15	9 (3x3)	15801.1548CHR	3510785432189	326,48
16	9 (3x3)	15801.1648CHR	3510785542202	326,48
20	9 (3x3)	15801.2048CHR	3510785432240	326,48

Chaînes d'épaisseur 9, 11, 13, 17 et 19 sur demande.

BOIS MASSIF



EXPERT



MOR.SF158.C44

MORTAISAGE PAS B = 15,8 - STANDARD FRANÇAIS -
CHAÎNE 44 MAILLONS



	MC(mm)	REF		€
6	2,5	15801.644	3510785423330	174,88
7	2,5	15801.744	3510785423293	174,88
8	4	15801.844	3510785422401	217,19
10	4	15801.1044	3510785422142	217,19
12	4	15801.1244	3510785422203	217,19
14	9 (3x3)	15801.1444	3510785422555	234,98
15	9 (3x3)	15801.1544	3510785422807	234,98
16	9 (3x3)	15801.1644	3510785422371	234,98
18	9 (3x3)	15801.1844	3510785423149	234,98
20	9 (3x3)	15801.2044	3510785422319	234,98
22	13,5 (3x4,5)	15801.2244	3510785423682	275,94
25	13,5 (3x4,5)	15801.2544	3510785423699	275,94
30	22,5 (5x4,5)	15801.3044	3510785422067	355,16

Chaînes d'épaisseur 9, 11, 13, 17 et 19 sur demande.



EXPERT



MOR.SF158.C46

MORTAISAGE PAS B = 15,8 - STANDARD FRANÇAIS -
CHAÎNE 46 MAILLONS



	MC(mm)	REF		€
6	2,5	15801.646	3510785422166	185,59
7	2,5	15801.746	3510785422944	185,59
8	4	15801.846	3510785422050	226,77
10	4	15801.1046	3510785421992	226,77
12	4	15801.1246	3510785422043	226,77
14	9 (3x3)	15801.1446	3510785422227	251,33
15	9 (3x3)	15801.1546	3510785422074	251,33
16	9 (3x3)	15801.1646	3510785422098	251,33
18	9 (3x3)	15801.1846	3510785422616	251,33
20	9 (3x3)	15801.2046	3510785422234	251,33
22	13,5 (3x4,5)	15801.2246	3510785423156	289,58
25	13,5 (3x4,5)	15801.2546	3510785422562	289,58
30	22,5 (5x4,5)	15801.3046	3510785422012	371,55



Chaînes d'épaisseur 9, 11, 13, 17 et 19 sur demande.

BOIS MASSIF

EXPERT 

MOR.SF158.C50

MORTAISAGE PAS B = 15,8 - STANDARD FRANÇAIS -
CHAÎNE 50 MAILLONS

	MC(mm)	REF		€
6	2,5	15801.650	3661589037244	198,03
7	2,5	15801.750	3510785423729	198,03
8	4	15801.850	3510785422654	244,51
10	4	15801.1050	3510785423125	244,51
12	4	15801.1250	3510785422821	244,51
14	9 (3x3)	15801.1450	3510785422715	270,48
15	9 (3x3)	15801.1550	3510785422395	270,48
16	9 (3x3)	15801.1650	3510785422517	270,48
18	9 (3x3)	15801.1850	3510785423651	270,48
20	9 (3x3)	15801.2050	3510785423101	270,48
22	13,5 (3x4,5)	15801.2250	3661589043979	312,79
25	13,5 (3x4,5)	15801.2550	3661589043986	312,79
30	22,5 (5x4,5)	15801.3050	3510785422890	401,57

Chaînes d'épaisseur 9, 11, 13, 17 et 19 sur demande.

BOIS MASSIF

EXPERT



MOR.DIVERS DIVERS GRAISSAGE



	REF		€
EMBASE GAL M10-M8	174.003	3510785423255	7,68
GRAISSEUR GLF CL5	174.004	3510785422609	8,94
GRAISSEUR MANUEL STAUFFER	174.005	3510785422951	16,39
TUBE DE GRAISSAGE 100MM	174.006.100	3661589075598	10,39
TUBE DE GRAISSAGE 125MM	174.006.125	3661589075604	10,39
TUBE DE GRAISSAGE 150MM	174.006.150	3661589075611	10,39

EXPERT



MOR.PR.EMBOUT EMBOUTS DE RECHANGE



	REF		€
EMBOUT 6-7X25-B-2,5	15805.6725	3510785423422	39,50
EMBOUT 6-7X30-B-2,5	15805.6730	3510785422265	39,50
EMBOUT 6-7X35-B-2,5	15805.6735	3510785423385	39,50
EMBOUT 8-12X25-B-4	15805.81225	3510785422524	39,50
EMBOUT 8-12X30-B-4	15805.81230	3510785421909	39,50
EMBOUT 8-12X35-B-4	15805.81235	3510785422296	39,50
EMBOUT 13-20X25-B-3X3	15805.132025	3510785422999	43,72
EMBOUT 13-20X30-B-3X3	15805.132030	3510785422029	43,72
EMBOUT 13-20X35-B-3X3	15805.132035	3510785422531	45,91
EMBOUT 22-25X30-B-3X4,5	15805.222530	3510785423279	49,65
EMBOUT 30X30-B-5X4,5	15805.3030	3510785422258	51,95
EMBOUT 30X35-B-5X4,5	15805.3035	3510785423163	51,95
EMBOUT 6-7X40-A-2,5	22605.6740	3510785423545	39,50
EMBOUT 6-7X50-A-2,5	22605.6750	3510785424146	47,30
EMBOUT 8-12X40-A-4	22605.81240	3510785422746	41,02
EMBOUT 8-12X50-A-4	22605.81250	3510785424153	47,30
EMBOUT 13-20X40-A-3X3	22605.132040	3510785423484	45,78
EMBOUT 13-20X50-A-3X3	22605.132050	3510785423408	48,92
EMBOUT 22-25X40-A-3X4,5	22605.222540	3510785424115	47,30
EMBOUT 22-25X50-A-3X4,5	22605.222550	3510785424122	53,68
EMBOUT 30X40-A-5X4,5	22605.3040	3510785423392	50,59
EMBOUT 30X50-A-5X4,5	22605.3050	3510785424139	56,88

BOIS MASSIF

MOR.PR.12VIS
12 VIS DE RECHANGE

	REF		€
SACHET 12 VIS EMBOUT 6-7x25-B-2,5	15807.6725	3661589075949	14,93
SACHET 12 VIS EMBOUT 6-7x30-B-2,5	15807.6730	3661589075956	14,93
SACHET 12 VIS EMBOUT 6-7x35-B-2,5	15807.6735	3661589075963	14,93
SACHET 12 VIS EMBOUT 8-12x25-B-4	15807.81225	3661589075970	14,93
SACHET 12 VIS EMBOUT 8-12x30-B-4	15807.81230	3661589075987	14,93
SACHET 12 VIS EMBOUT 8-12x35-B-4	15807.81235	3661589075994	14,93
SACHET 12 VIS EMBOUT 13-20x25-B-9	15807.132025	3661589076007	14,93
SACHET 12 VIS EMBOUT 13-20x30-B-9	15807.132030	3661589076014	14,93
SACHET 12 VIS EMBOUT 13-20x35-B-9	15807.132035	3661589076021	14,93
SACHET 12 VIS EMBOUT 22-25x30-B-3x4,5	15807.222530	3661589076038	14,93
SACHET 12 VIS EMBOUT 30x30-B-5x4,5	15807.3030	3661589076045	14,93
SACHET 12 VIS EMBOUT 6-7x40-A-2,5	22607.6740	3661589076069	14,93
SACHET 12 VIS EMBOUT 6-7x50-A-2,5	22607.6750	3661589076076	14,93
SACHET 12 VIS EMBOUT 8-12x40-A-4	22607.81240	3661589076083	14,93
SACHET 12 VIS EMBOUT 8-12x50-A-4	22607.81250	3661589076090	14,93
SACHET 12 VIS EMBOUT 13-20x40-A-9	22607.132040	3661589076106	14,93
SACHET 12 VIS EMBOUT 13-20x50-A-9	22607.132050	3661589076113	14,93
SACHET 12 VIS EMBOUT 22-25x40-A-3x4,5	22607.222540	3661589076120	14,93
SACHET 12 VIS EMBOUTS 22-25x50-A3x4,5	22607.222550	3661589076137	14,93
SACHET 12 VIS EMBOUT 30x40-A-5x4,5	22607.3040	3661589076144	14,93
SACHET 12 VIS EMBOUT 30x50-A-5x4,5	22607.3050	3661589076151	14,93
SACHET 12 VIS EMBOUT 25x30-B-3x5,8	17507.2530B	3661589076168	14,93
SACHET 12 VIS EMBOUT 28x30-A-3x5,8	17507.2830A	3661589076199	14,93
SACHET 12 VIS EMBOUT 28x30-B-3x5,8	17507.2830B	3661589076175	14,93
SACHET 12 VIS EMBOUT 28x35-A-3x5,8	17507.2835A	3661589076205	14,93
SACHET 12 VIS EMBOUT 28x40-A-3x5,8	17507.2840A	3661589076212	14,93
SACHET 12 VIS EMBOUT 30x30-B-3x5,8	17507.3030B	3661589076182	14,93

CHAÎNES À MORTAISER "STANDARD INTERNATIONAL"

PAS A = 22,6 mm PAS B = 15,8 mm

Les articles et pièces de rechange ci-dessous diffèrent du standard Français :

- Les guides sont équipés d'un graisseur manuel Stauffer, d'un tendeur de chaîne et ont une rainure de glissière (G) de 13 mm.
- Le chemin de roulement (Rlt) est de 17,4 mm, soit 3x5,8 mm (MC) pour les chaînes d'épaisseur de 25 à 30 mm.
- Les pignons ont 2 rangées de dents, 2 encoches et un alésage variant suivant le modèle de machine.
- Chaque embout est fourni avec des vis.
- Maillon en sachet de 2 + 6 rivets.

ATTENTION :

vérifier les cotes afin de vous assurer de la compatibilité de nos articles avec les différentes fabrications existantes.

MAKITA KC100

		MC(MM)	REF	GENCOD	€
CHAÎNE	25x30x100-B	17,4 (3x5,8)	17501.2536	3510781750010	378,37
GUIDE	25x30x100-B	17,4 (3x5,8)	17503.2530100	3510781750164	340,12
PIGNON (Al.16)	25x30x100-B	17,4 (3x5,8)	17504.25305D	3510781750256	45,12
Pièces de rechange					
EMBOUT GUIDE	25x30x100-B	17,4 (3x5,8)	17505.2530	3510781750355	106,60
MAILLON	25x30x100-B	17,4 (3x5,8)	17502.25B	3510781750126	57,41

RYOBI CM40 / MILWAUKEE CM100

		MC(MM)	REF	GENCOD	€
CHAÎNE	28x30x100-B	17,4 (3x5,8)	17501.2834	3510781750065	398,71
GUIDE	28x30x100-B	17,4 (3x5,8)	17503.2830100	3510781750171	377,17
PIGNON (Al.15)	28x30x100-B	17,4 (3x5,8)	17524.28306D	3510785422838	44,49
Pièces de rechange					
EMBOUT GUIDE	28x30x100-B	17,4 (3x5,8)	17505.2830	3510781750362	97,55
MAILLON	28x30x100-B	17,4 (3x5,8)	17502.28B	3510781750140	57,41
CHAÎNE	28x35x100-A	17,4 (3x5,8)	17501.2824	3510781750027	305,48
GUIDE	28x35x100-A	17,4 (3x5,8)	17503.2835100	3510781750188	377,17
PIGNON (Al.15)	28x35x100-A	17,4 (3x5,8)	17524.28354D	3510781750331	38,07
Pièces de rechange					
EMBOUT GUIDE	28x35x100-A	17,4 (3x5,8)	17505.2835	3510781750379	104,70
MAILLON	28x35x100-A	17,4 (3x5,8)	17502.28A	3510781750133	57,41
CHAÎNE	28x40x100-A	17,4 (3x5,8)	17501.2824	3510781750027	305,48
GUIDE	28x40x100-A	17,4 (3x5,8)	17503.2840100	3510781750201	338,49
PIGNON (Al.15)	28x40x100-A	17,4 (3x5,8)	17524.28404D	3510781750348	38,07
Pièces de rechange					
EMBOUT GUIDE	28x40x100-A	17,4 (3x5,8)	17505.2840	3510781750386	83,23
MAILLON	28x40x100-A	17,4 (3x5,8)	17502.28A	3510781750133	57,41

BOIS MASSIF

PROTOOL CMP150 / FESTOOL CM150

		MC(MM)	REF	GENCOD	€
CHAÎNE	30x30x150-B	17,4 (3x5,8)	17501.3042	3510785422302	527,72
GUIDE	30x30x150-B	17,4 (3x5,8)	17503.3030150	3510781750249	418,76
PIGNON (Al.16)	30x30x150-B	17,4 (3x5,8)	17504.28305D	3510781750263	45,12
Pièces de rechange					
EMBOUT GUIDE	30x30x150-B	17,4 (3x5,8)	17505.3030	3510781750409	103,29
MAILLON	30x30x150-B	17,4 (3x5,8)	17502.30B	3510781750157	57,41

MAFELL LS103

		MC(MM)	REF	GENCOD	€
CHAÎNE	28x35x100-A	17,4 (3x5,8)	17501.2824	3510781750027	305,48
GUIDE	28x35x100-A	17,4 (3x5,8)	17503.2835100	3510781750188	377,17
*PIGNON (Al.14)	28x35x100-A	17,4 (3x5,8)	17514.28354D	3510781750300	38,07
Pièces de rechange					
EMBOUT GUIDE	28x35x100-A	17,4 (3x5,8)	17505.2835	3510781750379	104,70
MAILLON	28x35x100-A	17,4 (3x5,8)	17502.28A	3510781750133	57,41
CHAÎNE	28x40x100-A	17,4 (3x5,8)	17501.2824	3510781750027	305,48
GUIDE	28x40x100-A	17,4 (3x5,8)	17503.2840100	3510781750201	338,49
**PIGNON (Al.14)	28x40x100-A	17,4 (3x5,8)	17514.28404D	3510781750317	38,07
Pièces de rechange					
EMBOUT GUIDE	28x40x100-A	17,4 (3x5,8)	17505.2840	3510781750386	83,23
MAILLON	28x40x100-A	17,4 (3x5,8)	17502.28A	3510781750133	57,41
CHAÎNE	28x35x150-A	17,4 (3x5,8)	17501.2829	3510781750034	367,18
GUIDE	28x35x150-A	17,4 (3x5,8)	17503.2835150	3510781750195	418,76
*PIGNON (Al.14)	28x35x150-A	17,4 (3x5,8)	17514.28354D	3510781750300	38,07
Pièces de rechange					
EMBOUT GUIDE	28x35x150-A	17,4 (3x5,8)	17505.2835	3510781750379	104,70
MAILLON	28x35x150-A	17,4 (3x5,8)	17502.28A	3510781750133	57,41
CHAÎNE	28x40x150-A	17,4 (3x5,8)	17501.2829	3510781750034	367,18
GUIDE	28x40x150-A	17,4 (3x5,8)	17503.2840150	3510781750218	398,82
**PIGNON (Al.14)	28x40x150-A	17,4 (3x5,8)	17514.28404D	3510781750317	38,07
Pièces de rechange					
EMBOUT GUIDE	28x40x150-A	17,4 (3x5,8)	17505.2840	3510781750386	83,23
MAILLON	28x40x150-A	17,4 (3x5,8)	17502.28A	3510781750133	57,41
CHAÎNE	30x30x100-B	17,4 (3x5,8)	17501.3034	3510781750102	397,45
GUIDE	30x30x100-B	17,4 (3x5,8)	17503.3030100	3510781750232	377,17
***PIGNON (Al.14)	30x30x100-B	17,4 (3x5,8)	17514.30306D	3510781750324	44,49
Pièces de rechange					
EMBOUT GUIDE	30x30x100-B	17,4 (3x5,8)	17505.3030	3510781750409	103,29
MAILLON	30x30x100-B	17,4 (3x5,8)	17502.30B	3510781750157	57,41
CHAÎNE	30x30x150-B	17,4 (3x5,8)	17501.3040	3510781750119	501,99
GUIDE	30x30x150-B	17,4 (3x5,8)	17503.3030150	3510781750249	418,76
***PIGNON (Al.14)	30x30x150-B	17,4 (3x5,8)	17514.30306D	3510781750324	44,49
Pièces de rechange					
EMBOUT GUIDE	30x30x150-B	17,4 (3x5,8)	17505.3030	3510781750409	103,29
MAILLON	30x30x150-B	17,4 (3x5,8)	17502.30B	3510781750157	57,41
* pour les MAFELL LS101 et LS102 utiliser les pignons en alésage 16 code 17504.28354D-A 3510781750270 38,07					
** pour les MAFELL LS101 et LS102 utiliser les pignons en alésage 16 code 17504.28404D-A 3510781750287 38,07					
*** pour les MAFELL LS101 et LS102 utiliser les pignons en alésage 16 code 17504.28305D-B 3510781750263 45,12					

EXPERT 



MOR.PR.2MAILLONS 2 MAILLONS DE RECHANGE



	REF		€
SACHET DE 2 MAILLONS 6-B-2.5 + 6 RIVETS	15802.6	3510785423521	19,16
SACHET DE 2 MAILLONS 7-B-2.5 + 6 RIVETS	15802.7	3510785423538	19,16
SACHET DE 2 MAILLONS 8-B-4 + 6 RIVETS	15802.8	3510785422722	21,38
SACHET DE 2 MAILLONS 10-B-4 + 6 RIVETS	15802.10	3510785422678	21,38
SACHET DE 2 MAILLONS 12-B-4 + 6 RIVETS	15802.12	3510785422883	21,38
SACHET DE 2 MAILLONS 14-B-3X3 + 6 RIVETS	15802.14	3510785422777	22,30
SACHET DE 2 MAILLONS 15-B-3X3 + 6 RIVETS	15802.15	3510785422623	22,30
SACHET DE 2 MAILLONS 16-B-3X3 + 6 RIVETS	15802.16	3510785423033	22,30
SACHET DE 2 MAILLONS 18-B-3X3 + 6 RIVETS	15802.18	3510785423088	22,30
SACHET DE 2 MAILLONS 20-B-3X3 + 6 RIVETS	15802.20	3510785422753	22,30
SACHET DE 2 MAILLONS 22-B-3X4.5 + 6 RIVETS	15802.22	3510785423552	26,95
SACHET DE 2 MAILLONS 25-B-3X4.5 + 6 RIVETS	15802.25	3510785423750	26,95
SACHET DE 2 MAILLONS 30-B-5X4.5 + 6 RIVETS	15802.30	3510785423248	26,95
SACHET DE 2 MAILLONS 6-A-2,5 + 6 RIVETS	22602.6	3510785424047	19,26
SACHET DE 2 MAILLONS 7-A-2,5 + 6 RIVETS	22602.7	3510785436446	19,26
SACHET DE 2 MAILLONS 8-A-4 + 6 RIVETS	22602.8	3510785423460	21,38
SACHET DE 2 MAILLONS 10-A-4 + 6 RIVETS	22602.10	3510785423446	21,38
SACHET DE 2 MAILLONS 12-A-4 + 6 RIVETS	22602.12	3510785423514	21,38
SACHET DE 2 MAILLONS 14-A-3X3 + 6 RIVETS	22602.14	3510785423453	22,30
SACHET DE 2 MAILLONS 15-A-3X3 + 6 RIVETS	22602.15	3510785423576	22,30
SACHET DE 2 MAILLONS 16-A-3X3 + 6 RIVETS	22602.16	3510785423361	22,30
SACHET DE 2 MAILLONS 18-A-3X3 + 6 RIVETS	22602.18	3510785424016	22,30
SACHET DE 2 MAILLONS 20-A-3X3 + 6 RIVETS	22602.20	3510785424023	22,30
SACHET DE 2 MAILLONS 22-A-3X4.5 + 6 RIVETS	22602.22	3510785424030	26,95
SACHET DE 2 MAILLONS 25-A-3X4.5 + 6 RIVETS	22602.25	3510785423491	26,95
SACHET DE 2 MAILLONS 30-A-5X4.5 + 6 RIVETS	22602.30	3510785423507	26,95

BOIS MASSIF

EXPERT MOR.PR.12RIVETS
12 RIVETS DE RECHANGE

	REF		€
SACHET 12 RIVETS 6-B-2,5	15806.6	3661589075628	14,93
SACHET 12 RIVETS 7-B-2,5	15806.7	3661589075659	14,93
SACHET 12 RIVETS 8-B-4	15806.8	3661589075666	14,93
SACHET 12 RIVETS 10-B-4	15806.10	3661589075673	14,93
SACHET 12 RIVETS 12-B-4	15806.12	3661589075680	14,93
SACHET 12 RIVETS 14-B-3x3	15806.14	3661589075697	14,93
SACHET 12 RIVETS 15-B-3x3	15806.15	3661589075703	14,93
SACHET 12 RIVETS 16-B-3x3	15806.16	3661589075710	14,93
SACHET 12 RIVETS 18-B-3x3	15806.18	3661589075727	14,93
SACHET 12 RIVETS 20-B-3x3	15806.20	3661589075734	14,93
SACHET 12 RIVETS 22-B-3x4,5	15806.22	3661589075741	14,93
SACHET 12 RIVETS 25-B-3x4,5	15806.25	3661589075758	14,93
SACHET 12 RIVETS 30-B-5x4,5	15806.30	3661589075765	14,93
SACHET 12 RIVETS 6-A-2,5	22606.6	3661589075772	14,93
SACHET 12 RIVETS 7-A-2,5	22606.7	3661589075789	14,93
SACHET 12 RIVETS 8-A-4	22606.8	3661589075796	14,93
SACHET 12 RIVETS 10-A-4	22606.10	3661589075802	14,93
SACHET 12 RIVETS 12-A-4	22606.12	3661589075819	14,93
SACHET 12 RIVETS 14-A-3x3	22606.14	3661589075826	14,93
SACHET 12 RIVETS 15-A-3x3	22606.15	3661589075833	14,93
SACHET 12 RIVETS 16-A-3x3	22606.16	3661589075840	14,93
SACHET 12 RIVETS 18-A-3x3	22606.18	3661589075857	14,93
SACHET 12 RIVETS 20-A-3x3	22606.20	3661589075864	14,93
SACHET 12 RIVETS 22-A-3x4,5	22606.22	3661589075871	14,93
SACHET 12 RIVETS 25-A-3x4,5	22606.25	3661589075888	14,93
SACHET 12 RIVETS 30-A-5x4,5	22606.30	3661589075895	14,93
SACHET 12 RIVETS 25-B-3x5,8	17506.25B	3661589075901	14,93
SACHET 12 RIVETS 28-A-3x5,8	17506.28A	3661589075932	14,93
SACHET 12 RIVETS 28-B-3x5,8	17506.28B	3661589075918	14,93
SACHET 12 RIVETS 30-B-3x5,8	17506.30B	3661589075925	14,93

BOIS MASSIF

CLASSIC



HSS

MOR.00306

MÈCHES À BÉDANE CARRÉ



- Perçage et réalisation de mortaises carrées dans les bois tendres et durs.
- Adaptation sur machines stationnaires mortaiseuses bédane.

Ø				REF		€
6x6	15,9	135	45	306.506.45	3510783065013	34,41
8x8	15,9	140	50	306.508.50	3510783065020	37,34
10x10	15,9	140	60	306.510.60	3510783065037	37,34
12x12	15,9	140	70	306.512.70	3510783065044	37,34
14x14	15,9	140	75	306.514.75	3510783065051	40,15
16x16	15,9	160	95	306.516.95	3510783065075	43,06
18x18	15,9	160	95	306.518.95	3510783065082	48,17

CLASSIC



MOR.00306.00

DOUILLE DE RÉDUCTION



- Idéal pour adaptation sur d'autres marques de machines.

Ø	REF		€
19 à 15,9	306.1916.00	3510783065228	13,70

CLASSIC



MOR.00306.04

COFFRET DE 4 BÉDANES



- Section 6x6 - 8x8 - 10x10 - 12x12

	REF		€
15,9	306.500.04	3510783065402	109,30

HSS

BOIS MASSIF

CLASSIC



MOR.00322

MÈCHES À MORTAISER HÉLICOÏDALES



- 2 coupes hélicoïdales brise-copeaux à haut rendement.
- Qualité professionnelle.

Ø	Flutes	Longueur	LU	Rotation	REF	Code	€
6	6	100	40	L	322.506.01	3510785402311	19,81
6	6	100	40	R	322.506.00	3510785402182	19,81
8	8	115	50	L	322.508.01	3510785402335	21,22
8	8	115	50	R	322.508.00	3510785402199	21,22
10	10	125	60	L	322.510.01	3510785402359	21,22
10	10	125	60	R	322.510.00	3510785402229	21,22
12	12	135	65	L	322.512.01	3510785402373	21,59
12	12	135	65	R	322.512.00	3510785402243	21,59
14	13	145	65	L	322.514.01	3510785402397	21,87
14	13	145	65	R	322.514.00	3510785402267	21,87
16	13	155	70	L	322.516.01	3510785402410	23,22
16	13	155	70	R	322.516.00	3510785402281	23,22
18	13	155	70	L	322.518.01	3510785402427	23,22
18	13	155	70	R	322.518.00	3510785402298	23,22
20	13	155	70	L	322.520.01	3510785402434	23,22
20	13	155	70	R	322.520.00	3510785402304	23,22

CLASSIC



MOR.00322.05

COFFRET DE 6 MÈCHES À MORTAISER HÉLICOÏDALES



- 2 coupes hélicoïdales brise-copeaux à haut rendement.
- Qualité professionnelle.
- Ø 6 - 8 - 10 - 12 - 14 - 16.

Ø	Rotation	REF	Code	€
6 à 13	L	322.500.01	3510783225011	62,61
6 à 13	R	322.500.00	3510783225004	62,61

WS

CLASSIC



MOR.00301

MÈCHES À MORTAISER STANDARD



- 2 coupes droites avec rainure brise-copeaux.

					REF		€
6	6	110	50	L	301.506.01	3510783010617	6,34
6	6	110	50	R	301.506.00	3510783010600	6,34
8	8	120	45	L	301.508.01	3510783010815	6,87
8	8	120	45	R	301.508.00	3510783010808	6,87
10	10	120	55	L	301.510.01	3510783011010	7,96
10	10	120	55	R	301.510.00	3510783011003	7,96
12	12	120	70	L	301.512.01	3510783011218	9,04
12	12	120	70	R	301.512.00	3510783011201	9,04
14	13	150	60	L	301.514.01	3510783011416	13,42
14	13	150	60	R	301.514.00	3510783011409	13,42
16	13	150	60	L	301.516.01	3510783011614	16,39
16	13	150	60	R	301.516.00	3510783011607	16,39





info@leman-sa.com

DISQUES À LAMELLES ET MEULES

 MÉTAL

P. 328

 PIERRE

P. 336

EXPERT  pour les travaux spécialisés et de haute technicité.

CLASSIC  pour les travaux courants et polyvalents.



EXPERT



CERAMIC



EN13743

DLM.00311
DISQUE À LAMELLES CÉRAMIQUE



- Abrasif céramique et aluminium d'oxyde avec un agent additif anti-échauffement.
- Toile polyester.
- Idéal pour des travaux intensifs sur meuleuses ou machines automatiques.
- Longévité extrême et forte capacité d'enlèvement.
- Support: fibre de verre.

ACIER, ACIER INOXYDABLE

Ø	Grain	Ø	Ø	Ø	REF	Q	Q	€
125	40	22,23	12250	B	3112540	10	3661589014399	6,73
125	60	22,23	12250	B	3112560	10	3661589014405	6,73
125	80	22,23	12250	B	3112580	10	3661589014412	6,73
125	120	22,23	12250	B	3112512	10	3661589031198	6,73
125	40	22,23	12250	P	3212540	10	3661589031204	6,73
125	60	22,23	12250	P	3212560	10	3661589031211	6,73
125	80	22,23	12250	P	3212580	10	3661589031228	6,73
125	120	22,23	12250	P	3212512	10	3661589031235	6,73

EXPERT



CERAMIC



EN13743

DLM.00331
DISQUE À LAMELLES CÉRAMIQUE BORD ARRONDI

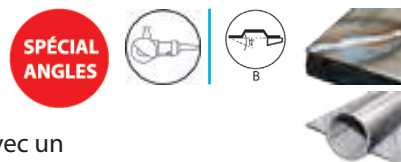

- Abrasif céramique et aluminium d'oxyde avec un agent additif anti-échauffement.
- Toile polyester.
- Idéal pour des travaux intensifs sur meuleuses ou machines automatiques.
- Longévité extrême et forte capacité d'enlèvement.
- Support: fibre de verre.

ACIER, ACIER INOXYDABLE

Ø	Grain	Ø	Ø	Ø	REF	Q	Q	€
125	40	22,23	12250	B	3312540	10	3661589052698	7,88
125	60	22,23	12250	B	3312560	10	3661589052704	7,88
125	80	22,23	12250	B	3312580	10	3661589052711	7,88

MÉTAL



DLM.00211

DISQUE À LAMELLES ZIRCONIUM

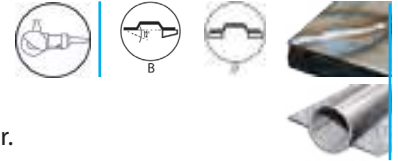

- Abrasif zirconium, toile mixte coton polyester.
- Excellente abrasion et durée de vie.
- Convient parfaitement pour des travaux sur arêtes.
- Support: fibre de verre.

Z

ACIER, ACIER INOXYDABLE

EN13743

∅					REF			€
125	40	22,23	12250	B	2112540	10	3661589014184	5,20
125	60	22,23	12250	B	2112560	10	3661589014191	5,20
125	80	22,23	12250	B	2112580	10	3661589014207	5,20
125	120	22,23	12250	B	2112512	10	3661589014160	5,20
115	40	22,23	13300	P	2211540	10	3661589014269	4,83
115	60	22,23	13300	P	2211560	10	3661589014276	4,83
115	80	22,23	13300	P	2211580	10	3661589014283	4,83
125	40	22,23	12250	P	2212540	10	3661589014306	5,20
125	60	22,23	12250	P	2212560	10	3661589014313	5,20
125	80	22,23	12250	P	2212580	10	3661589014320	5,20
125	120	22,23	12250	P	2212512	10	3661589014290	5,20
180	40	22,23	8500	P	2218040	10	3661589014337	9,77
180	60	22,23	8500	P	2218060	10	3661589014344	9,77
180	80	22,23	8500	P	2218080	10	3661589014351	9,77



DLM.00241
DISQUE À DOUBLES LAMELLES ZIRCONIUM



- Abrasif zirconium, résine.
- Support: PVC.

Z

EN13743

ACIER, ACIER INOXYDABLE

Ø	Grain	Ø	Grain	Grain	REF	Icon	Icon	€
125	40	22,23	12250	P	2412540	10	3661589031242	4,15
125	60	22,23	12250	P	2412560	10	3661589031259	4,15
125	80	22,23	12250	P	2412580	10	3661589031266	4,15
125	120	22,23	12250	P	2412512	10	3661589031273	4,15



DLM.00115.Z
DISQUE À LAMELLES ZIRCONIUM

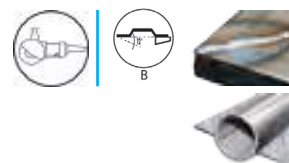

- Abrasif zirconium, résine.
- Support: fibre de verre.

Z

EN13743

ACIER, ACIER INOXYDABLE

Ø	Grain	Ø	Grain	Grain	REF	Icon	Icon	€
115	40	22,23	13300	B	115.040Z	10	3510781154016	3,63
115	60	22,23	13300	B	115.060Z	10	3510781156010	3,63
115	80	22,23	13300	B	115.080Z	10	3510781158014	3,63
115	100	22,23	13300	B	115.100Z	10	3510781159912	3,63
115	120	22,23	13300	B	115.120Z	10	3510781151206	3,63
125	40	22,23	12250	B	125.040Z	10	3510781254013	4,20
125	60	22,23	12250	B	125.060Z	10	3510781256017	4,20
125	80	22,23	12250	B	125.080Z	10	3510781258011	4,20
125	100	22,23	12250	B	125.100Z	10	3510781259919	4,20
125	120	22,23	12250	B	125.120Z	10	3510781251210	4,20

DISQUES À LAMELLES ET MEULES

MÉTAL



DLM.00115.A

DISQUE À LAMELLES CORINDON

- Abrasif: corindon, résine.
- Support: fibre de verre.

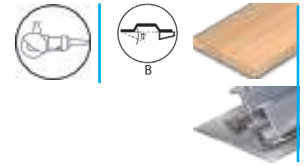

A

ACIER, BOIS

EN13743

Ø	Grain	Ø	Grain	Grain	REF	Q	Q	€
115	40	22,23	13300	B	115.040A	10	3510780115407	2,85
115	60	22,23	13300	B	115.060A	10	3510780115605	2,85
115	80	22,23	13300	B	115.080A	10	3510780115803	2,85
115	100	22,23	13300	B	115.100A	10	3510780115995	2,85
115	120	22,23	13300	B	115.120A	10	3510780100267	2,85
125	40	22,23	12250	B	125.040A	10	3510780125406	3,37
125	60	22,23	12250	B	125.060A	10	3510780125604	3,37
125	80	22,23	12250	B	125.080A	10	3510780125802	3,37
125	100	22,23	12250	B	125.100A	10	3510780125994	3,37
125	120	22,23	12250	B	125.120A	10	3510780100328	3,37



DLM.00411

DISQUE NYLON

- Disque nylon plat.
- Résine au carbure de silicium sur plateaux fibre de verre.
- Pour nettoyer, poncer et polir toutes les surfaces (acier, bois, rouille, colle).

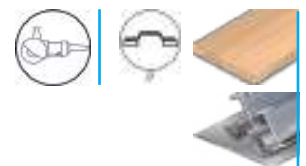

NYLON

ACIER, BOIS, PEINTURE, VERNIS, PVC

EN13743

Ø	Ø	Ø	Grain	Grain	REF	Q	Q	€
115	22,23	15	10500	P	4111570	10	3661589014429	6,94
125	22,23	15	9650	P	4112570	10	3661589014436	8,25
180	22,23	15	6700	P	4118070	10	3661589014443	20,44

CLASSIC



DLM.00993

ROUE À LAMELLES CORINDON

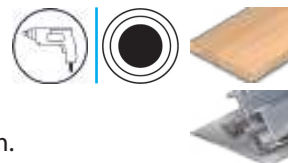

- Roue à lamelles toile abrasive montée sur tige ø 6 mm.
- Toile conton X, corindon brun.
- Liant résine.
- Pour des opérations d'ébavurage, préparation de surfaces.

A

EN13743

ACIER, BOIS

Ø					REF			€
30	6	15	60	25000	9931560	10	3661589021793	4,73
30	6	15	80	25000	9931580	10	3661589021809	4,73
30	6	15	120	25000	9931512	10	3661589021786	4,73
40	6	15	60	19000	9941560	10	3661589021823	5,20
40	6	15	80	19000	9941580	10	3661589021830	5,20
40	6	15	120	19000	9941512	10	3661589021816	5,20
50	6	15	60	15000	9951560	10	3661589021854	5,63
50	6	15	80	15000	9951580	10	3661589021861	5,63
50	6	15	120	15000	9951512	10	3661589021847	5,63
60	6	30	60	12000	9963060	10	3661589021885	6,94
60	6	30	80	12000	9963080	10	3661589021892	6,94
60	6	30	120	12000	9963012	10	3661589021878	6,94
80	6	30	60	9000	9983060	10	3661589021915	9,77
80	6	30	80	9000	9983080	10	3661589021922	9,77
80	6	30	120	9000	9983012	10	3661589021908	9,77

DISQUES À LAMELLES ET MEULES

MÉTAL



DLM.00150.V
MEULE VITRIFIÉE VERTE



- Meulage des outils au carbure.
- Meule plate vitrifiée en carbure silicium.
- Rotation: 35 m/s.
- Livrée avec bagues de réduction 32/25,4 - 25,4/20 - 20/16 - 16/12,8

CARBURE
SILICIUM

EN12413

					REF			€
150	80	32	20	4500	15028	1	3661589049322	24,38
150	120	32	20	4500	15029	1	3510780150286	24,38
150	80	32	25	4500	15528	1	3510780155281	27,90
150	120	32	25	4500	15529	1	3510780155298	27,90
200	80	32	20	3350	22028	1	3510780220286	44,92
200	120	32	20	3350	22029	1	3510780220293	44,92
200	80	32	25	3350	22528	1	3510780225281	46,97
200	120	32	25	3350	22529	1	3510780225298	46,97
200	80	32	32	3350	23228	1	3510780232289	44,92
200	120	32	32	3350	23229	1	3510780232296	44,92

CLASSIC



DLM.00150.B
MEULE VITRIFIÉE BLANCHE



- Meulage des aciers rapides.
- Corindon supérieur.
- Rotation: 35 m/s.
- Livrée avec bagues de réduction 32/25,4 - 25,4/20 - 20/16 - 16/12,7 (sauf meule \varnothing 125 mm)

A

EN12413

					REF			€
125	60	20	20	5350	12017	1	3510780120173	16,14
150	46	32	20	4500	15014	1	3510780150149	21,54
150	60	32	20	4500	15016	1	3661589006912	21,96
150	60	32	25	4500	15516	1	3510780155168	21,96
200	46	32	20	3350	22014	1	3510780220149	35,62
200	60	32	20	3350	22016	1	3510780220163	36,20
200	46	32	25	3350	22514	1	3510780225144	36,20
200	60	32	25	3350	22516	1	3510780225168	36,20
200	60	32	32	3350	23216	1	3510780232166	35,62

DISQUES À LAMELLES ET MEULES

MÉTAL



DLM.00150.G
MEULE VITRIFIÉE GRISE



- Meulage des aciers ordinaires.
- Corindon métal.
- Rotation: 35 m/s.
- Livrée avec bagues de réduction 32/25,4 - 25,4/20 - 20/16 - 16/12,7

A

EN12413

					REF			€
150	24	32	20	4500	15002	1	3510780150026	17,76
150	60	32	20	4500	15006	1	3510780150064	17,76
150	24	32	25	4500	15502	1	3510780155021	19,83
150	60	32	25	4500	15506	1	3510780155069	19,83
200	24	32	20	3350	22002	1	3510780220026	29,16
200	60	32	20	3350	22006	1	3510780220064	29,16
200	24	32	25	3350	22502	1	3661589006769	31,78
200	60	32	25	3350	22506	1	3661589006776	31,78
200	24	32	32	3350	23202	1	3510780232029	31,78
200	60	32	32	3350	23206	1	3510780232067	32,73
250	60	32	32	2700	25006	1	3510780250061	61,93

CLASSIC

DLM.03220
LOT DE 4 BAGUES DE REDUCTION



	REF			€
32/25,4 - 25,4/20 - 20/16 - 16/12,7	3220.03	1	3661589030115	3,70

PIERRE

CLASSIC



DLM.00112 DISQUE SEMI-RIGIDE

- Carbure de silicium, résine.
- Support: fibre vulcanisée indéchirable.
- A utiliser avec plateau caoutchouc ABR.PLA.M14

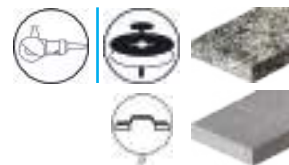

CARBURE
SILICIUM

EN13743

PIERRE, BÉTON, RÉSINE, GRANIT, MARBRE, CIMENT, PLÂTRE

Ø					REF			€
115	16	22,23	13300	P	11216	10	3510780112161	4,47
115	24	22,23	13300	P	11224	10	3510780112246	4,47
115	36	22,23	13300	P	11236	10	3510780112369	4,47
115	60	22,23	13300	P	11260	10	3510780112604	4,47
115	80	22,23	13300	P	11280	10	3510780112802	4,47
115	120	22,23	13300	P	11212	10	3510780112123	4,47
125	16	22,23	12250	P	12216	10	3510780122160	4,95
125	24	22,23	12250	P	12224	10	3510780122245	4,95
125	36	22,23	12250	P	12236	10	3510780122368	4,95
125	60	22,23	12250	P	12260	10	3510780122603	4,95
125	80	22,23	12250	P	12280	10	3510780122801	4,95
125	120	22,23	12250	P	12212	10	3510780122122	4,95
180	16	22,23	8500	P	18216	10	3510780182164	5,94
180	24	22,23	8500	P	18224	10	3510780182249	5,94
180	36	22,23	8500	P	18236	10	3510780182362	5,94
180	60	22,23	8500	P	18260	10	3510780182607	5,94
180	80	22,23	8500	P	18280	10	3510780182805	5,94
180	120	22,23	8500	P	18212	10	3510780182126	5,94

DISQUES À LAMELLES ET MEULES

PIERRE



DLM.00511
DISQUE SEMI-FLEX

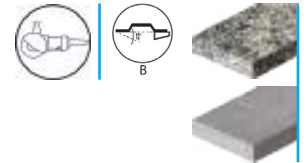

- Support: fibre de verre.
- Liant résine synthétique à haute résistance.
- Couche abrasive en grains de carbure silicium.
- Pour poncer, polir, nettoyer, décaper sur des surfaces planes.
- Travail avec un angle d'inclinaison de 20°.

CARBURE
SILICIUM

EN13743

PIERRE, BÉTON, RÉSINE, GRANIT, MARBRE, CIMENT, PLÂTRE

Ø	Grain	Ø	Grain	Grain	REF	Icon	Icon	€
125	16	22,23	12250	B	5112516	10	3661589015686	5,89
125	24	22,23	1250	B	5112524	10	3661589015693	5,89
125	36	22,23	12250	B	5112536	10	3661589015709	5,89
125	60	22,23	12250	B	5112560	10	3661589015716	5,89



DLM.00601
MEULE BOISSEAU BAKÉLITE

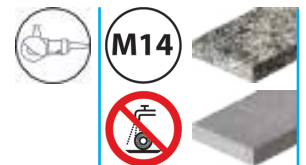

- Fixation M14
- Ponçage à sec pierre et béton.
- Carbure silicium.

CARBURE
SILICIUM

EN12413

PIERRE, BÉTON, GRANIT, MARBRE

Ø	Grain	Ø	Grain	REF	Icon	Icon	€
130/100	16	55	7350	6013016	5	3661589007612	25,06
130/100	24	55	7350	6013024	5	3661589007629	25,06
130/100	36	55	7350	6013036	5	3661589007636	25,06
130/100	60	55	7350	6013060	5	3661589007643	25,06
130/100	80	55	7350	6013080	5	3661589007650	25,06
130/100	120	55	7350	6013012	5	3661589007667	25,06

PIERRE

EXPERT



DLM.00502
MEULE COURONNE BAKÉLITE

- 4 écrous M10
- Ponçage à sec pierre et béton.
- Carbure silicium.

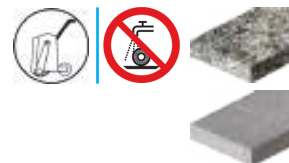

CARBURE SILICIUM

EN12413

PIERRE, BÉTON, GRANIT, MARBRE

					REF			€
250	16	160	50	3850	5025050	1	3661589007582	103,91
270/250	16	170	50	3500	5027050	1	3661589007599	73,02
300	16	200	50	3200	5030050	1	3661589007605	97,77

EXPERT



DLM.00702
PIERRE À GRÉSER

- Ponçage manuel des surplus de béton.
- Carbure silicium vitrifié.

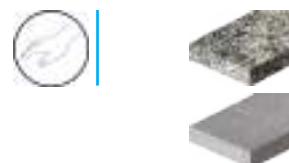

CARBURE SILICIUM

PIERRE, BÉTON, GRANIT, MARBRE

				REF			€
200	50	16	25	7020016	10	3661589007674	7,83
200	50	24	25	7020024	10	3661589007681	7,83
200	50	36	25	7020036	10	3661589007698	7,83
200	50	60	25	7020060	10	3661589007704	7,83
200	50	80	25	7020080	10	3661589007711	7,83
200	50	120	25	7020012	10	3661589007728	7,83





info@leman-sa.com

ABRASIFS

	BOIS MASSIF	P. 342
	MÉTAL	P. 350
	MULTI-MATÉRIAUX	P. 353
	PIERRE	P. 370
	PLÂTRE ET MATÉRIAUX TENDRES	P. 371
	ACCESSOIRES	P. 378

EXPERT  pour les travaux spécialisés et de haute technicité.

CLASSIC  pour les travaux courants et polyvalents.

BOIS MASSIF

EXPERT







ABR.B200.CB BANDE SANS FIN TOILE LARGE

- Support toile X avec joint par recouvrement.
- Liant résine.



PARQUET, BOIS, PEINTURE, VERNIS

A

				REF		€
200	482	24	10	200.480.024	3510788248244	7,15
200	482	36	10	200.480.036	3510782048369	7,10
200	482	24	10	200.480.040	3510782482408	6,52
200	482	60	10	200.480.060	3510782482606	6,10
200	482	80	10	200.480.080	3510782482804	5,63
200	482	100	10	200.480.100	3510782482101	5,63
200	482	120	10	200.480.120	3510782482125	5,63
200	551	24	10	200.550.024	3510782550244	7,62
200	551	36	10	200.550.036	3510782550367	7,30
200	551	40	10	200.550.040	3510782550404	6,83
200	551	60	10	200.550.060	3510782550602	6,00
200	551	80	10	200.550.080	3510782550800	6,00
200	551	100	10	200.550.100	3510782550107	6,00
200	551	120	10	200.550.120	3510782550121	6,00
200	750	24	10	200.750.024	3510782750248	8,62
200	750	36	10	200.750.036	3510782750361	7,73
200	750	40	10	200.750.040	3510782750408	7,73
200	750	60	10	200.750.060	3510782750606	7,30
200	750	80	10	200.750.080	3510782750804	6,83
200	750	100	10	200.750.100	3510782750101	6,83
200	750	120	10	200.750.120	3510782750125	6,83

BOIS MASSIF

EXPERT 







ABR.RL203.SI ROULEAU PAPIER LARGE

- Papier poids E.
- Liant double résine.



CARBURE
SILICIUM

PARQUET, PIERRE, MARBRE, BÉTON

				REF		€
203	50 m	24	1	4320324	3661589014801	224,68
203	50 m	36	1	4320336	3661589014818	204,93
203	50 m	40	1	4320340	3661589014825	168,26
203	50 m	50	1	4320350	3661589014832	147,61
203	50 m	60	1	4320360	3661589014849	128,39
203	50 m	80	1	4320380	3661589014856	112,05
203	50 m	100	1	4320310	3661589014771	112,05
203	50 m	120	1	4320312	3661589014788	112,05

EXPERT 







ABR.P203.SI PATIN PAPIER PRE-DECOUPE

- Papier poids E.
- Liant double résine.



CARBURE
SILICIUM

PARQUET, PIERRE, MARBRE, BÉTON

				REF		€
203	476	24	25	4647624	3661589014979	3,05
203	476	36	25	4647636	3661589014986	2,16
203	476	40	25	4647640	3661589014993	2,05
203	476	60	25	4647660	3661589015006	1,90
203	476	80	25	4647680	3661589015013	1,58
203	476	100	25	4647610	3661589014955	1,48
203	476	120	25	4647612	3661589014962	1,48

BOIS MASSIF

EXPERT



ABR.D150.180.SI DISQUE PAPIER SPECIAL SOL

- Papier poids E.
- Liant double résine.



PARQUET, PIERRE, MARBRE

CARBURE
SILICIUM

				REF		€
150	12	36	25	4815036	3661589015211	0,90
150	12	40	25	4815040	3661589015228	0,85
150	12	50	25	4815050	3661589015235	0,80
150	12	60	25	4815060	3661589015242	0,68
150	12	80	25	4815080	3661589015259	0,58
150	12	100	25	4815010	3661589015181	0,58
150	12	120	25	4815012	3661589015198	0,58
180	12	36	25	4818036	3661589015365	1,16
180	12	40	25	4818040	3661589015372	1,16
180	12	60	25	4818060	3661589015389	0,90
180	12	80	25	4818080	3661589015396	0,80
180	12	100	25	4818010	3661589015334	0,80
180	12	120	25	4818012	3661589015341	0,80
180	22	36	25	4818236	3661589015433	1,16
180	22	40	25	4818240	3661589015440	1,16
180	22	60	25	4818260	3661589015457	0,90
180	22	80	25	4818280	3661589015464	0,80
180	22	100	25	4818210	3661589015402	0,80
180	22	120	25	4818212	3661589015419	0,80

BOIS MASSIF

EXPERT







CARBURE
SILICIUM

ABR.D406.SI DISQUE TREILLIS SPECIAL SOL



- Grille abrasives anti-encrassement.
- Liant résine.
- Montage sur disque d'entraînement velcro avec mousse.

PARQUET, PIERRE, MARBRE

			REF		€
406	60	10	4740661	3661589015082	6,47
406	80	10	4740681	3661589015099	6,47
406	100	10	4740691	3661589015105	6,47
406	120	10	4740611	3661589015075	6,47

EXPERT







CARBURE
SILICIUM

ABR.D406.432.SI DISQUE PAPIER DOUBLE FACE



- Papier poids E.
- Liant double résine.

PARQUET, PIERRE, MARBRE

				REF		€
406	25	16	10	4940016	3661589015488	18,44
406	25	24	10	4940024	3661589015495	18,44
406	25	36	10	4940036	3661589015501	15,50
406	25	40	10	4940040	3661589015518	15,50
406	25	60	10	4940060	3661589015525	11,56
406	25	80	10	4940080	3661589015532	10,57
406	25	120	10	4940012	3661589015471	10,20
432	30	16	10	4943216	3661589015556	18,76
432	30	24	10	4943224	3661589015563	18,76
432	30	36	10	4943236	3661589015570	15,92
432	30	40	10	4943240	3661589015587	15,92
432	30	60	10	4943260	3661589015594	11,99

BOIS MASSIF

EXPERT 







ABR.D406.508.PAD DISQUE PAD DE NETTOYAGE



- Pad en fibres synthétiques polyester non tissées.

CARRELAGE, MARBRE, PARQUET

			REF		€
406	B	5	5240601	3661589015938	9,25
406	G	5	5240602	3661589015945	9,25
406	W	5	5240603	3661589015952	9,25
406	R	5	5240605	3661589015976	9,25
432	B	5	5243001	3661589016034	10,72
432	G	5	5243002	3661589016041	10,72
432	W	5	5243003	3661589016058	10,72

EXPERT 



ABR.PLA.PAD SUPPORT DISQUE TREILLIS



		REF		€
406	10	5240600	3661589042040	8,10

BOIS MASSIF

CLASSIC



ABR.B100.150.CB

BANDE SANS FIN SPECIALE MACHINE STATIONNAIRE

- Support toile X avec joint par recouvrement.
- Liant double résine.



BOIS

A

				REF		€
100	914	40	2	7191440	3661589017413	5,57
100	914	60	2	7191460	3661589017420	5,05
100	914	80	2	7191480	3661589017437	4,58
100	914	100	2	7191410	3661589017390	4,58
100	914	120	2	7191412	3661589017406	4,58
100	914	150	2	7191415	3661589058911	4,58
150	1219	40	2	7112140	3661589016966	21,64
150	1219	60	2	7112160	3661589016973	18,44
150	1219	80	2	7112180	3661589016980	17,76
150	1219	120	2	7112112	3661589016942	17,07
150	1219	220	2	7112122	3661589016959	17,07

BOIS MASSIF

SUR COMMANDE





BANDE PAPIER LARGE / LONGUE

- Corindon.
- Papier poids E.
- Liant double résine.



BOIS, PEINTURE, VERNIS, PLASTIQUE

	100 à 240	80	60		
100x	1,60	1,85	2,15	1,85	10
120x	1,95	2,20	2,60	2,15	10
150x	2,55	2,85	3,20	2,70	10
200x	3,30	3,75	4,30	3,60	10
300x	4,95	5,50	6,40	5,25	10
610x	9,90	10,60	13,05	11,00	10
630x	10,25	11,45	13,40	11,40	10
910x	14,75	17,10	19,25	16,45	10
1100x	17,90	20,70	23,45	19,75	10



BANDE PAPIER LARGE / LONGUE

- Corindon.
- Papier poids F.
- Liant double résine.



BOIS, PANNEAUX PLAQUÉS

	100 à 240	80	60		
100x	1,85	2,10	2,45	1,85	10
120x	2,20	2,50	2,85	2,15	10
150x	2,70	3,05	3,65	2,70	10
200x	3,75	4,10	4,80	3,60	10
300x	5,45	6,20	7,05	5,25	10
610x	10,90	12,45	14,35	11,00	10
630x	11,40	12,90	14,90	11,40	10
910x	16,45	18,60	21,50	16,45	10
1100x	19,75	22,45	25,95	19,75	10

BOIS MASSIF

SUR COMMANDE

BANDE TOILE LARGE / LONGUE

- Corindon.
- Toile coton X.
- Liant double résine.



MÉTAL, BOIS, ALUMINIUM

	100 à 240	80	60	50	40	36	JOINT KEVLAR	JOINT STANDARD ABRASIF MEULÉ	
75x	3,50	3,75	4,10	4,35	4,90	5,15	3,00	1,50	10
80x	3,70	4,05	4,30	4,65	5,15	5,40	3,20	1,65	10
90x	4,15	4,60	4,90	5,25	5,75	6,05	3,60	1,65	10
100x	4,50	5,15	5,40	5,85	6,35	6,65	4,10	1,95	10
120x	5,45	6,05	6,55	7,00	7,65	8,15	4,85	2,40	10
150x	6,85	7,55	8,15	8,75	9,40	10,15	5,95	2,95	10
200x	9,10	10,10	10,85	11,75	12,55	13,45	8,00	3,85	10
250x	11,30	12,45	13,55	14,60	15,70	16,80	9,95	4,85	10
300x	13,65	15,10	16,35	17,95	18,90	20,20	13,25	5,90	10

Mode de calcul du prix
 largeur x longueur
 prix du grain au mètre
 + Joint
 = Prix de la bande

MÉTAL

EXPERT



CERAMIC

ABR.D125.180.CE DISQUE FIBRE CERAMIQUE

- Forte capacité d'enlèvement.
- Support en fibres souple très résistant.
- Traitement anti-échauffement.
- Liant résine.

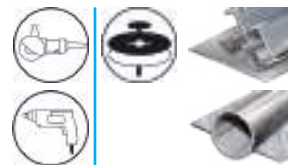

MÉTAL, ACIER INOXYDABLE

Ø	Ø	Ø	Ø	REF	Ø	€
125	12250	24	25	6412524	3661589062536	2,21
125	12250	36	25	6412536	3661589062543	2,21
125	12250	60	25	6412560	3661589062574	2,21
125	12250	80	25	6412580	3661589062581	2,21
125	12250	120	25	6412512	3661589062604	2,21
180	8500	24	25	6418024	3661589062611	2,68
180	8500	36	25	6418036	3661589062628	2,68
180	8500	60	25	6418060	3661589062659	2,68
180	8500	80	25	6418080	3661589062666	2,68
180	8500	120	25	6418012	3661589062680	2,68

A utiliser sur plateau réf. ABR.PLA.T6/ABR.PLA.M14

CLASSIC



Z

ABR.D125.180.ZI DISQUE FIBRE ZIRCONIUM

- Support en fibres souple très résistant.
- Liant résine.

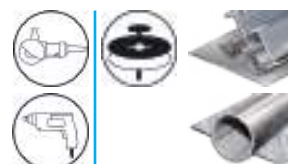

MÉTAL, ACIER INOXYDABLE

Ø	Ø	Ø	Ø	REF	Ø	€
125	12250	24	25	6212524	3661589016638	1,68
125	12250	36	25	6212536	3661589016645	1,68
125	12250	60	25	6212560	3661589016652	1,68
125	12250	80	25	6212580	3661589016669	1,68
125	12250	120	25	6212512	3661589016621	1,68
180	8500	36	25	6218036	3661589016690	2,00
180	8500	60	25	6218060	3661589016706	2,00

A utiliser sur plateau réf. ABR.PLA.T6/ABR.PLA.M14

MÉTAL

CLASSIC



ABR.F28.PI FEUILLE PAPIER IMPERMEABLE

- Support latex poids B ou C.
- Liant double résine.



MÉTAL, CARROSSERIE

A

					REF		€
230	280	60		50	9723506	3661589021281	0,95
230	280	80		50	9723508	3661589021298	0,90
230	280	100		50	9723510	3661589021304	0,80
230	280	120		50	9723512	3661589021311	0,68
230	280	150		50	9723515	3661589021328	0,58
230	280	180		50	9723518	3661589021335	0,58
230	280	220		50	9723522	3661589021342	0,58
230	280	240		50	9723524	3661589021359	0,58
230	280	280		50	9723528	3661589021366	0,58
230	280	320		50	9723532	3661589021373	0,58
230	280	400		50	9723540	3661589021397	0,58
230	280	500		50	9723550	3661589021403	0,58
230	280	600		50	9723560	3661589021410	0,58
230	280	800		50	9723580	3661589021427	0,58
230	280	1000		50	9723598	3661589021434	0,58
230	280	1200		50	9723599	3661589021441	0,58
230	280	180	C	15 lots de 8	PI.081	3510780040815	5,20
230	280	240	C	15 lots de 8	PI.082	3510780040822	5,20
230	280	400	C	15 lots de 8	PI.083	3510780040839	5,20
230	280	600	C	15 lots de 8	PI.086	3661589006356	5,20
230	280	180	BL	Lot de 4	PI.01	3510784230014	3,84
230	280	240	BL	Lot de 4	PI.02	3510784230021	3,84
230	280	400	BL	Lot de 4	PI.03	3510784230038	3,84
230	280	600	BL	Lot de 4	PI.04	3510784230045	3,84

CLASSIC



ABR.F28.TE
FEUILLE TOILE EMERI

- Toile emeri coton souple.
- Liant double colle.



MÉTAL, MÉTAUX NON FERREUX

CARBURE
SILICIUM

					REF		€
230	280	40		50	9723640	3661589021496	0,90
230	280	60		50	9723660	3661589021502	0,90
230	280	80		50	9723680	3661589021519	0,90
230	280	100		50	9723610	3661589021458	0,90
230	280	120		50	9723612	3661589021465	0,90
230	280	150		50	9723615	3661589021472	0,90
230	280	180		50	9723618	3661589021489	0,90
230	280	40	C	15 lots de 8	TE.086	3661589006363	6,36
230	280	60	C	15 lots de 8	TE.081	3510780050814	6,36
230	280	100	C	15 lots de 8	TE.082	3510780050821	6,36
230	280	150	C	15 lots de 8	TE.083	3510780050838	6,36
230	280	40	BL	Lot de 4	TE.00	3510785230006	4,58
230	280	60	BL	Lot de 4	TE.01	3510785230013	4,58
230	280	100	BL	Lot de 4	TE.02	3510785230020	4,58
230	280	150	BL	Lot de 4	TE.03	3510785230037	4,58

MULTI-MATÉRIAUX

CLASSIC



ABR.B9.100.CB

BANDE SANS FIN POUR MACHINE PORTATIVE

- Support toile X avec joint par recouvrement.
- Liant double résine.

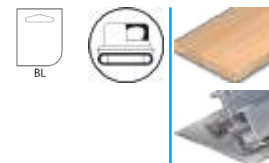







BOIS, PEINTURE, VERNIS, MÉTAL

A

						REF		€
9		533	40		10	09.533.040	3510780533041	0,90
9		533	60		10	09.533.060	3510780533065	0,90
9		533	80		10	09.533.080	3510780533089	0,90
9		533	100		10	09.533.100	3510780533102	0,90
9		533	120		10	09.533.120	3510780533126	0,90
13		454	40		10	13.454.040	3510781345445	0,95
13		454	60		10	13.454.060	3510781345469	0,95
13		454	80		10	13.454.080	3510781345483	0,95
13		454	100		10	13.454.100	3510781345490	0,95
13		454	120		10	13.454.120	3510781345421	0,95
13		454	40	BL	Lot de 6	13454.01	3510781145410	8,30
13		454	80	BL	Lot de 6	13454.02	3510781145427	8,30
13		454	120	BL	Lot de 6	13454.03	3510781145434	8,30
30		533	40		10	30.533.040	3510783053348	1,48
30		533	60		10	30.533.060	3510783053362	1,37
30		533	80		10	30.533.080	3510783053386	1,32
30		533	100		10	30.533.100	3510783053393	1,32
30		533	120		10	30.533.120	3510783053324	1,32
75		457	40		10	75.457.040	3510787545740	2,21
75		457	60		10	75.457.060	3510787545764	2,10
75		457	80		10	75.457.080	3510787545788	2,05
75		457	100		10	75.457.100	3510787545795	2,05
75		457	120		10	75.457.120	3510787545726	2,05
75		457	40	BL	Lot de 3	75457.01	3510787645716	8,83
75		457	80	BL	Lot de 3	75457.02	3510787645723	7,99
75		457	120	BL	Lot de 3	75457.03	3510787645730	7,73
75		510	40		10	75.510.040	3510787551048	2,48
75		510	60		10	75.510.060	3510787551062	2,32
75		510	80		10	75.510.080	3510787551086	2,21
75		510	100		10	75.510.100	3510787551093	2,16
75		510	120		10	75.510.120	3510787551024	2,16
75		533	40		10	75.533.040	3510787553349	2,48
75		533	60		10	75.533.060	3510787553363	2,32

MULTI-MATÉRIAUX

					REF		€
75	533	80		10	75.533.080	3510787553387	2,32
75	533	100		10	75.533.100	3510787553394	2,21
75	533	120		10	75.533.120	3510787553325	2,21
75	533	40	BL	Lot de 3	75533.01	3510787653315	9,62
75	533	80	BL	Lot de 3	75533.02	3510787653322	8,62
75	533	120	BL	Lot de 3	75533.03	3510787653339	8,35
75	610	40		10	75.610.040	3510787561047	2,53
75	610	60		10	75.610.060	3510787561061	2,53
75	610	80		10	75.610.080	3510787561085	2,32
75	610	100		10	75.610.100	3510787561092	2,21
75	610	120		10	75.610.120	3510787561023	2,21
75	610	40	BL	Lot de 3	75610.01	3510787661013	10,40
75	610	80	BL	Lot de 3	75610.02	3510787661020	9,04
75	610	120	BL	Lot de 3	75610.03	3510787661037	8,94
100	560	40		10	100.560.040	3510781056044	3,26
100	560	60		10	100.560.060	3510781056068	3,00
100	560	80		10	100.560.080	3510781056082	2,85
100	560	100		10	100.560.100	3510781056099	2,73
100	560	120		10	100.560.120	3510781056020	2,73
100	560	40	BL	Lot de 3	100560.01	3510781156119	11,30
100	560	80	BL	Lot de 3	100560.02	3510781156027	10,82
100	560	120	BL	Lot de 3	100560.03	3510781156034	10,51
100	610	40		10	100.610.040	3510781061048	3,37
100	610	60		10	100.610.060	3510781061062	3,00
100	610	80		10	100.610.080	3510781061086	2,90
100	610	100		10	100.610.100	3510781061093	2,90
100	610	120		10	100.610.120	3510781061024	2,90
100	610	40	BL	Lot de 3	100610.01	3510781161014	12,82
100	610	80	BL	Lot de 3	100610.02	3510781161021	11,35
100	610	120	BL	Lot de 3	100610.03	3510781161038	11,25
100	620	40		10	100.620.040	3510781062045	3,47
100	620	60		10	100.620.060	3510781062069	3,21
100	620	80		10	100.620.080	3510781062083	3,15
100	620	100		10	100.620.100	3510781062090	3,15
100	620	120		10	100.620.120	3510781062021	3,15
100	620	40	BL	Lot de 3	100620.01	3510781162011	13,82
100	620	80	BL	Lot de 3	100620.02	3510781162028	12,82
100	620	120	BL	Lot de 3	100620.03	3510781162035	11,14
100	690	40		10	100.690.040	3510780100908	4,15
100	690	60		10	100.690.060	3510781069600	3,78
100	690	80		10	100.690.080	3510781069808	3,58
100	690	100		10	100.690.100	3510780100915	3,26
100	690	120		10	100.690.120	3510781069129	3,26

MULTI-MATÉRIAUX

CLASSIC



ABR.RL120.CB ROULEAU PAPIER MULTI-USAGES

- Papier poids E.
- Liant double résine.



BOIS, PEINTURE, VERNIS, MÉTAL

A

				REF		€
120	25	40	1	8212040	3661589019417	37,72
120	25	60	1	8212060	3661589019424	36,40
120	25	80	1	8212080	3661589019431	34,78
120	25	100	1	8212010	3661589019370	34,78
120	25	120	1	8212012	3661589019387	34,78
120	25	150	1	8212015	3661589019394	34,78
120	25	180	1	8212018	3661589019400	34,78
120	25	240	1	8212024	3661589031327	34,78

CLASSIC



ABR.RL38.115.CB ROULEAU TOILE SOUPLE MULTI-USAGES

- Toile coton souple.
- Liant double résine.







BOIS, PEINTURE, VERNIS, MÉTAL

A

				REF		€
38	25	40	1	3825.040	3510783825044	23,59
38	25	60	1	3825.060	3510783825068	19,91
38	25	80	1	3825.080	3510783825082	18,97
38	25	100	1	3825.100	3510783825105	17,66
38	25	120	1	3825.120	3510783825129	17,02
38	25	150	1	3825.150	3510783825150	17,02
38	25	180	1	3825.180	3510783825181	17,02
38	25	220	1	3825.220	3510783825228	17,02
38	25	240	1	3825.240	3510783825242	17,02
38	25	320	1	3825.320	3510783825327	17,02

MULTI-MATÉRIAUX

				REF		€
38	25	400	1	3825.400	3510783825426	17,02
50	25	40	1	5025.040	3510785025046	30,95
50	25	60	1	5025.060	3510785025060	26,21
50	25	80	1	5025.080	3510785025084	25,11
50	25	100	1	5025.100	3510785025107	23,54
50	25	120	1	5025.120	3510785025121	23,54
50	25	180	1	5025.180	3510785025183	23,54
50	25	220	1	5025.220	3510785025220	23,54
50	25	240	1	5025.240	3510785025244	23,54
100	25	40	1	10025.040	3510781025040	60,41
100	25	60	1	10025.060	3510781025064	52,28
100	25	80	1	10025.080	3510781025088	48,64
100	25	100	1	10025.100	3510781025101	45,44
100	25	120	1	10025.120	3510781025125	45,44
100	25	150	1	10025.150	3510781025156	45,44
100	25	180	1	10025.180	3510781025187	45,44
100	25	220	1	10025.220	3510781025224	45,44
100	25	240	1	10025.240	3510781025248	45,44
100	25	320	1	10025.320	3510781025323	45,44
115	25	40	1	11525.040	3510781125047	63,57
115	25	60	1	11525.060	3510781125061	54,74
115	25	80	1	11525.080	3510781125085	50,64
115	25	100	1	11525.100	3510781125108	48,39
115	25	120	1	11525.120	3510781125122	48,39
115	25	150	1	11525.150	3510781125153	48,39
115	25	180	1	11525.180	3510781125184	48,39
115	25	220	1	11525.220	3510781125221	48,39
115	25	240	1	11525.240	3510781125245	48,39
115	25	320	1	11525.320	3510781125320	48,39

MULTI-MATÉRIAUX

CLASSIC



ABR.D115.180.CB DISQUE FIBRE MULTI-USAGES

- Support en fibres souple très résistant.
- Liant résine.



BOIS, PEINTURE, VERNIS, MÉTAL

A

Ø				REF		€
115	16		25	6111516	3661589016386	0,80
115	24		25	6111524	3661589016393	0,80
115	36		25	6111536	3661589016409	0,80
115	50		25	6111550	3661589016416	0,80
115	60		25	6111560	3661589016423	0,80
115	80		25	6111580	3661589016430	0,80
115	100		25	6111510	3661589016362	0,80
115	120		25	6111512	3661589016379	0,80
115	36	A	15 lots de 5	117.51	3510780117517	6,36
115	80	A	15 lots de 5	117.52	3510780117524	6,36
115	120	A	15 lots de 5	117.53	3510780117531	6,36
125	16		25	6112516	3661589016461	1,05
125	24		25	6112524	3661589016478	1,05
125	36		25	6112536	3661589016485	1,05
125	50		25	6112550	3661589016492	1,05
125	60		25	6112560	3661589016508	1,05
125	80		25	6112580	3661589016515	1,05
125	100		25	6112510	3661589016447	1,05
125	120		25	6112512	3661589016454	1,05
125	36	A	15 lots de 5	127.51	3510780127516	7,73
125	80	A	15 lots de 5	127.52	3510780127523	7,73
125	120	A	15 lots de 5	127.53	3510780127530	7,73
180	16		25	6118016	3661589016546	1,68
180	24		25	6118024	3661589016553	1,68
180	36		25	6118036	3661589016560	1,68
180	50		25	6118050	3661589016577	1,68
180	60		25	6118060	3661589016584	1,68
180	80		25	6118080	3661589016591	1,68
180	100		25	6118010	3661589016522	1,68
180	120		25	6118012	3661589016539	1,68
180	36	B	15 lots de 5	187.51	3510780187510	10,93
180	80	B	15 lots de 5	187.52	3510780187527	10,93
180	120	B	15 lots de 5	187.53	3510780187534	10,93

A utiliser sur plateau réf. ABR.PLA.T6/ABR.PLA.M14

MULTI-MATÉRIAUX

CLASSIC



ABR.D125.150.ST DISQUE VELCRO ANTI-ENCRESSANT

- Papier latex poids C.
- Liant double résine.

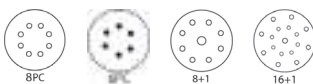

ANTI
ENCRESSANT

BOIS, PEINTURE, VERNIS, CARROSSERIE

Ø				REF		€
125	80	8PC	50	125.08.081	3661589079213	0,74
125	120	8PC	50	125.08.121	3661589079220	0,74
125	150	8PC	50	125.08.151	3661589079237	0,74
125	180	8PC	50	125.08.181	3510781258189	0,74
125	220	8PC	50	125.08.221	3510781258226	0,74
125	240	8PC	50	125.08.241	3510781258240	0,74
125	320	8PC	50	125.08.321	3510781258325	0,74
125	400	8PC	50	125.08.401	3510781258417	0,74
150	80	6PC	50	150.06.081	3661589079244	0,80
150	120	6PC	50	150.06.121	3661589079251	0,80
150	150	6PC	50	150.06.151	3661589079268	0,80
150	180	6PC	50	150.06.181	3510781506181	0,80
150	220	6PC	50	150.06.221	3510781506228	0,80
150	240	6PC	50	150.06.241	3510781506242	0,80
150	320	6PC	50	150.06.321	3510781506327	0,80
150	400	6PC	50	150.06.401	3510781506402	0,80
150	80	8+1	50	150.09.081	3661589079275	0,80
150	120	8+1	50	150.09.121	3510780102568	0,80
150	150	8+1	50	150.09.151	3661589079282	0,80
150	180	8+1	50	150.09.181	3510781509182	0,80
150	220	8+1	50	150.09.221	3510781509229	0,80
150	240	8+1	50	150.09.241	3510781509243	0,80
150	320	8+1	50	150.09.321	3510781509328	0,80
150	400	8+1	50	150.09.401	3510781509410	0,80
150	80	16+1	50	150.17.081	3661589079350	0,80
150	120	16+1	50	150.17.121	3661589079367	0,80
150	150	16+1	50	150.17.151	3661589079374	0,80
150	180	16+1	50	150.17.181	3661589079381	0,80
150	220	16+1	50	150.17.221	3661589079398	0,80
150	240	16+1	50	150.17.241	3661589079404	0,80
150	320	16+1	50	150.17.321	3661589079411	0,80
150	400	16+1	50	150.17.401	3661589079428	0,80

MULTI-MATÉRIAUX



ABR.D115.150.CB DISQUE VELCRO MULTI-USAGES

- Papier poids E.
- Liant double résine.

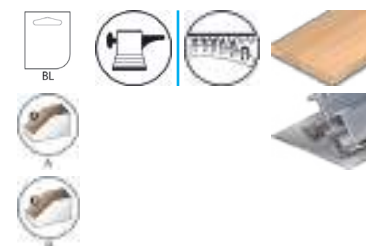







BOIS, PEINTURE, VERNIS, MÉTAL

A

Ø					REF		€
115	40	8PC			115.08.040	3510781158045	0,80
115	60	8PC			115.08.060	3510781158069	0,74
115	80	8PC			115.08.080	3510781158083	0,74
115	100	8PC			115.08.100	3510781158106	0,74
115	120	8PC			115.08.120	3510781158120	0,74
115	40	8PC	A	15 lots de 8	11508.81	3661589030726	5,89
115	80	8PC	A	15 lots de 8	11508.82	3661589030733	5,89
115	120	8PC	A	15 lots de 8	11508.83	3661589030740	5,89
115	40	8PC	BL	Lot de 6	115.08.01	3510781158113	5,89
115	80	8PC	BL	Lot de 6	115.08.02	3510781158021	5,89
115	120	8PC	BL	Lot de 6	115.08.03	3510781158038	5,89
125	40	SP			125.00.040	3510781250046	0,80
125	60	SP			125.00.060	3510781250060	0,80
125	80	SP			125.00.080	3510781250084	0,74
125	100	SP			125.00.100	3510781250107	0,74
125	120	SP			125.00.120	3510781250121	0,74
125	40	8PC			125.08.040	3510781258042	0,80
125	60	8PC			125.08.060	3510781258066	0,80
125	80	8PC			125.08.080	3510781258080	0,74
125	100	8PC			125.08.100	3510781258103	0,74
125	120	8PC			125.08.120	3510781258127	0,74
125	150	8PC			125.08.150	3510781258158	0,74
125	40	8PC	A	15 lots de 8	12508.81	3661589030764	6,36
125	80	8PC	A	15 lots de 8	12508.82	3661589030771	6,36
125	120	8PC	A	15 lots de 8	12508.83	3661589030788	6,36
125	40	8PC	BL	Lot de 6	125.08.01	3510781258110	6,36
125	80	8PC	BL	Lot de 6	125.08.02	3510781258028	6,36
125	120	8PC	BL	Lot de 6	125.08.03	3510781258035	6,36
150	40	SP			150.00.040	3510781501049	0,95
150	60	SP			150.00.060	3510781501063	0,85

MULTI-MATÉRIAUX

					REF		€
150	80	SP		50	150.00.080	3510781501087	0,80
150	100	SP		50	150.00.100	3510781501100	0,80
150	120	SP		50	150.00.120	3510781501124	0,80
150	150	SP		50	150.00.150	3510781501155	0,80
150	40	6PC		50	150.06.040	3510781506044	0,95
150	60	6PC		50	150.06.060	3510781506068	0,85
150	80	6PC		50	150.06.080	3510781506082	0,80
150	100	6PC		50	150.06.100	3510781506105	0,80
150	120	6PC		50	150.06.120	3510781506129	0,80
150	150	6PC		50	150.06.150	3510781506150	0,80
150	40	6PC	B	15 lots de 8	15006.81	3661589030801	7,35
150	80	6PC	B	15 lots de 8	15006.82	3661589030818	7,35
150	120	6PC	B	15 lots de 8	15006.83	3661589030825	7,35
150	40	6PC	BL	Lot de 6	150.06.01	3510781506013	7,35
150	80	6PC	BL	Lot de 6	150.06.02	3510781506020	7,35
150	120	6PC	BL	Lot de 6	150.06.03	3510781506037	7,35
150	40	8PC		50	150.80.040	3510781508048	0,95
150	60	8PC		50	150.80.060	3510781508062	0,85
150	80	8PC		50	150.80.080	3510781508086	0,80
150	100	8PC		50	150.80.100	3510781508017	0,80
150	120	8PC		50	150.80.120	3510781508123	0,80
150	150	8PC		50	150.80.150	3510781508154	0,80
150	40	8+1		50	150.09.040	3510781509403	0,95
150	60	8+1		50	150.09.060	3510781509601	0,85
150	80	8+1		50	150.09.080	3510781509809	0,80
150	100	8+1		50	150.09.100	3510781509106	0,80
150	120	8+1		50	150.09.120	3510781509120	0,80
150	150	8+1		50	150.09.150	3510781509151	0,80
150	40	16+1		50	150.17.040	3661589079299	0,95
150	60	16+1		50	150.17.060	3661589079305	0,85
150	80	16+1		50	150.17.080	3661589079312	0,80
150	100	16+1		50	150.17.100	3661589079329	0,80
150	120	16+1		50	150.17.120	3661589079336	0,80
150	150	16+1		50	150.17.150	3661589079343	0,80

MULTI-MATÉRIAUX

CLASSIC



ABR.D150.305.CB DISQUE PAPIER ADHESIF

- Papier poids E.
- Liant double résine.



BOIS, PEINTURE, VERNIS, MÉTAL

∅				REF		€
150	40	SP	10	9415040	3661589020437	0,90
150	60	SP	10	9415060	3661589020444	0,53
150	80	SP	10	9415080	3661589020451	0,53
150	120	SP	10	9415012	3661589031495	0,53
150	220	SP	10	9415022	3661589020420	0,53
250	40	SP	10	9425040	3661589020475	2,16
250	60	SP	10	9425060	3661589020482	2,05
250	80	SP	10	9425080	3661589020499	1,95
250	120	SP	10	9425012	3661589031501	1,85
250	220	SP	10	9425022	3661589022578	1,85
300	40	SP	10	9430540	3661589020529	2,63
300	60	SP	10	9430560	3661589020536	2,48
300	80	SP	10	9430580	3661589020543	2,26
300	120	SP	10	9430512	3661589031518	2,21
300	220	SP	10	9430522	3661589020512	2,21

MULTI-MATÉRIAUX

CLASSIC



A

ABR.D200.300.CB DISQUE VELCRO POUR COMBINE

- Papier poids E.
- Liant double résine.

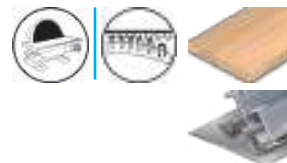

BOIS, PEINTURE, VERNIS, MÉTAL

Ø				REF		€
200	40	SP	10	200.00.040	3510782000404	2,10
200	60	SP	10	200.00.060	3510782000602	1,85
200	80	SP	10	200.00.080	3510782000800	1,68
200	120	SP	10	200.00.120	3510782001203	1,68
200	220	SP	10	200.00.220	3510782002200	1,63
250	40	SP	10	250.00.040	3661589023247	3,68
250	60	SP	10	250.00.060	3661589023254	3,21
250	80	SP	10	250.00.080	3661589023261	3,10
250	120	SP	10	250.00.120	3661589023278	2,95
250	220	SP	10	250.00.220	3661589023285	2,95
300	40	SP	10	300.00.040	3510783000403	4,05
300	60	SP	10	300.00.060	3510783000601	3,58
300	80	SP	10	300.00.080	3510783000809	3,37
300	120	SP	10	300.00.120	3510783001202	3,26
300	220	SP	10	300.00.220	3661589023292	3,26

CLASSIC



ABR.PLA.AD INTERFACE ADHESIF/VELCRO

- Support adhésif pour disque velcro.
- Diamètre 150mm pour ponceuses excentriques.
- Diamètres 250 et 305 mm pour machines lapidaires.



Ø		REF		€
150	1	9515000	3661589020666	4,20
250	1	9525000	3661589020673	24,48
300	1	9530000	3661589020680	28,63

MULTI-MATÉRIAUX

CLASSIC



ABR.P93.115.CB PATIN VELCRO MULTI-USAGES

- Papier poids E.
- Liant double résine.



BOIS, PEINTURE, VERNIS, MÉTAL

A

							REF		€
93	185	40	8P	A	15 lots de 8		93185.08.81	3661589030566	8,52
93	185	80	8P	A	15 lots de 8		93185.08.82	3661589030573	8,52
93	185	120	8P	A	15 lots de 8		93185.08.83	3661589030580	8,52
93	185	40	8P	BL	Lot de 6		93185.08.01	3510780103503	8,52
93	185	80	8P	BL	Lot de 6		93185.08.02	3510780103510	8,52
93	185	120	8P	BL	Lot de 6		93185.08.03	3510780103527	8,52
93	185	40	6+2	BL	Lot de 6		93185.62.01	3510780103541	8,52
93	185	80	6+2	BL	Lot de 6		93185.62.02	3510780103558	8,52
93	185	120	6+2	BL	Lot de 6		93185.62.03	3510780103565	8,52
115	230	40	10P	A	15 lots de 8		115230.10.81	3661589030603	12,40
115	230	80	10P	A	15 lots de 8		115230.10.82	3661589030610	12,40
115	230	120	10P	A	15 lots de 8		115230.10.83	3661589030627	12,40
115	230	40	10P	BL	Lot de 6		115230.10.01	3510780103589	12,45
115	230	80	10P	BL	Lot de 6		115230.10.02	3510780103596	12,45
115	230	120	10P	BL	Lot de 6		115230.10.03	3510780103602	12,45

MULTI-MATÉRIAUX

CLASSIC



ABR.P73.CB PATIN VELCRO POUR CALE A PONCER

- Papier poids E.
- Liant double résine.



BOIS, PEINTURE, VERNIS, MÉTAL

A

						REF		€
73	125	40			50	9837204	3661589023322	0,53
73	125	60			50	9837206	3661589023339	0,53
73	125	80			50	9837208	3661589023346	0,53
73	125	100			50	9837220	3661589023407	0,53
73	125	120			50	9837212	3661589023353	0,53
73	125	150			50	9837215	3661589023360	0,53
73	125	180			50	9837218	3661589023377	0,53
73	125	240			50	9837224	3661589023384	0,53
73	125	40		A	15 lots de 10	70125.101	3510781251012	5,20
73	125	80		A	15 lots de 10	70125.102	3510781251029	5,20
73	125	120		A	15 lots de 10	70125.103	3510781251036	5,20
73	125	180		A	15 lots de 10	70125.104	3510780103688	5,20

MULTI-MATÉRIAUX

CLASSIC



ABR.TR100.CB FLECHE VELCRO MULTI-USAGES

- Papier poids E.
- Liant double résine.



BOIS, PEINTURE, VERNIS, MÉTAL

A

						REF		€
100	170	40	8PC	BL	Lot de 6	100170.08.01	3510780170017	7,99
100	170	80	8PC	BL	Lot de 6	100170.08.02	3510780170024	7,99
100	170	120	8PC	BL	Lot de 6	100170.08.03	3510780170031	7,99

CLASSIC



ABR.TR93.CB TRIANGLE VELCRO MULTI-USAGES

- Papier poids E.
- Liant double résine.

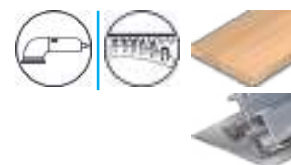

BOIS, PEINTURE, VERNIS, MÉTAL

A

					REF		€
93	93	40	6PEX	50	9693040	3661589020895	0,58
93	93	60	6PEX	50	9693060	3661589020901	0,58
93	93	80	6PEX	50	9693080	3661589020918	0,58
93	93	120	6PEX	50	9693120	3661589020932	0,58
93	93	180	6PEX	50	9693180	3661589020949	0,58

MULTI-MATÉRIAUX



ABR.TR94.CB TRIANGLE VELCRO MULTI-USAGES

- Papier poids E.
- Liant double résine.



BOIS, PEINTURE, VERNIS, MÉTAL

A

						REF		€
94	95	40	6PC		50	9694040	3661589020970	0,58
94	95	60	6PC		50	9694060	3661589020987	0,58
94	95	80	6PC		50	9694080	3661589020994	0,58
94	95	120	6PC		50	9694120	3661589021014	0,58
94	95	180	6PC		50	9694180	3661589021021	0,58
94	94	40	6PC	A	15 lots de 8	094094.06.81	3661589030849	6,15
94	94	80	6PC	A	15 lots de 8	094094.06.82	3661589030856	6,15
94	94	120	6PC	A	15 lots de 8	094094.06.83	3661589030863	6,15
94	94	40	6PC	BL	Lot de 6	094094.06.01	3510780094016	6,15
94	94	80	6PC	BL	Lot de 6	094094.06.02	3510780094023	6,15
94	94	120	6PC	BL	Lot de 6	094094.06.03	3510780094030	6,15

MULTI-MATÉRIAUX

CLASSIC



ABR.F28.CB FEUILLE TOILE MULTI-USAGES

- Support toile J souple.
- Liant double résine.



BOIS, ACIER INOXYDABLE, MÉTAL

A

				REF		€
230	280	60	50	9723760	3661589021588	2,00
230	280	80	50	9723780	3661589021595	2,00
230	280	100	50	9723710	3661589021526	1,73
230	280	120	50	9723712	3661589021533	1,73

CLASSIC



ABR.F28.CO FEUILLE PAPIER MULTI-USAGES

- Papier poids B.
- Liant double résine.



BOIS, PEINTURE, VERNIS, MÉTAL

A

				REF		€
230	280	40	50	PO040	3510780105743	0,68
230	280	60	50	PO060	3510780105767	0,58
230	280	80	50	PO080	3510780105774	0,48
230	280	100	50	PO100	3510780105781	0,48
230	280	120	50	PO120	3510780105798	0,48
230	280	150	50	PO150	3510780105804	0,48
230	280	180	50	PO180	3510780105859	0,48
230	280	220	50	PO220	3510780105811	0,48
230	280	240	50	PO240	3510780105828	0,48
230	280	280	50	PO280	3510780105835	0,48
230	280	320	50	PO320	3510780105842	0,48

MULTI-MATÉRIAUX

CLASSIC



ABR.F28.ST FEUILLE PAPIER ANTI-ENCRASSANT

- Support latex poids A.
- Liant résine/colle.



PEINTURE, VERNIS, MATIÈRES PLASTIQUES, MASTIC

ANTI
ENCRASSANT

					REF		€
230	280	80		50	9723408	3661589021205	0,80
230	280	100		50	9723410	3661589021212	0,68
230	280	120		50	9723412	3661589021229	0,58
230	280	150		50	9723415	3661589021236	0,58
230	280	180		50	9723418	3661589021243	0,58
230	280	240		50	9723424	3661589021250	0,58
230	280	400		50	9723440	3661589021274	0,58
230	280	80	C	15 lots de 8	PA.086	3661589006318	5,47
230	280	120	C	15 lots de 8	PA.087	3661589006325	5,47
230	280	180	C	15 lots de 8	PA.088	3661589006332	5,47
230	280	240	C	15 lots de 8	PA.089	3661589006349	5,47
230	280	80	BL	Lot de 4	PA.11	3661589001276	3,63
230	280	120	BL	Lot de 4	PA.12	3661589001283	3,63
230	280	180	BL	Lot de 4	PA.13	3661589001290	3,63
230	280	240	BL	Lot de 4	PA.14	3661589001306	3,63

MULTI-MATÉRIAUX

CLASSIC

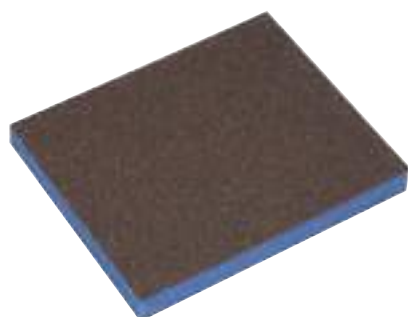

ABR.EP2.CB EPONGE A MAIN 2 FACES

- Support souple en mousse.
- 2 faces abrasives.



BOIS, PEINTURE, VERNIS, MÉTAL, PLÂTRE

A

					REF		€
98	120	13	60	10	9898060	3661589021724	1,11
98	120	13	100	10	9898100	3661589021731	1,11
98	120	13	180	10	9898180	3661589021748	1,11

CLASSIC

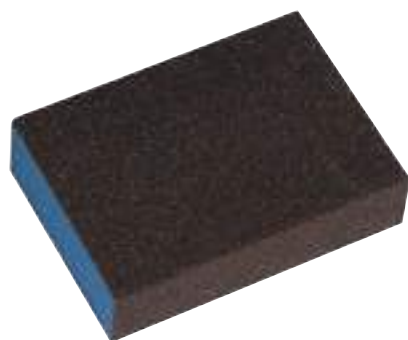

ABR.EP4.CB EPONGE A MAIN 4 FACES

- Support souple en mousse.
- 4 faces abrasives.



BOIS, PEINTURE, VERNIS, MÉTAL, PLÂTRE

A

					REF		€
69	98	26	60	10	9870060	3661589021694	1,16
69	98	26	100	10	9870100	3661589021700	1,16
69	98	26	180	10	9870180	3661589021717	1,16

PIERRE

CLASSIC



CARBURE
SILICIUM

ABR.D125.180.SI DISQUE FIBRE PIERRE

- Support en fibres souple très résistant.
- Liant résine.

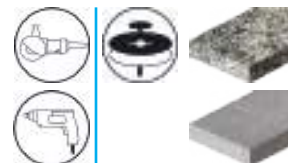

PIERRE, BÉTON, MARBRE, CIMENT

Ø				REF		€
125	12250	16	25	6312516	3661589016812	1,16
125	12250	24	25	6312524	3661589016829	1,16
125	12250	36	25	6312536	3661589016836	1,16
125	12250	60	25	6312560	3661589016843	1,16
125	12250	80	25	6312580	3661589016850	1,16
125	12250	100	25	6312510	3661589016799	1,16
125	12250	120	25	6312512	3661589016805	1,16
180	8500	16	25	6318016	3661589016881	1,53
180	8500	24	25	6318024	3661589016898	1,53
180	8500	36	25	6318036	3661589016904	1,53
180	8500	60	25	6318060	3661589016911	1,53
180	8500	80	25	6318080	3661589016928	1,53
180	8500	100	25	6318010	3661589016867	1,53
180	8500	120	25	6318012	3661589016874	1,53

A utiliser sur plateau réf. ABR.PLA.T6/ABR.PLA.M14

PLÂTRE ET MATÉRIAUX TENDRES

CLASSIC



ABR.F28.PV FEUILLE PAPIER DE VERRE

- Papier poids B.
- Liant double colle.



PLÂTRE, BOIS, PEINTURE, VERNIS

SILEX

					REF		€
230	280	40		50	9723140	3661589021083	0,38
230	280	60		50	9723160	3661589021090	0,27
230	280	80		50	9723180	3661589021106	0,27
230	280	100		50	9723110	3661589021052	0,27
230	280	120		50	9723112	3661589021069	0,27
230	280	180		50	9723118	3661589021076	0,27
230	280	40	C	15 lots de 8	PV.086	3661589006295	2,73
230	280	60	C	15 lots de 8	PV.081	3510780010818	2,73
230	280	80	C	15 lots de 8	PV.082	3510780010825	2,73
230	280	120	C	15 lots de 8	PV.083	3510780010832	2,73
230	280	40	BL	Lot de 4	PV.00	3510781230000	2,26
230	280	60	BL	Lot de 4	PV.01	3510781230017	2,21
230	280	80	BL	Lot de 4	PV.02	3510781230024	2,21
230	280	120	BL	Lot de 4	PV.03	3510781230031	2,21

PLÂTRE ET MATÉRIAUX TENDRES

CLASSIC



ABR.F28.CJ FEUILLE PAPIER CORINDON JAUNE

- Papier poids C (D pour les grains 40 et 60).
- Liant double résine.

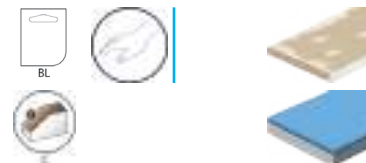

PLÂTRE, PEINTURE, VERNIS, MASTIC

A

					REF		€
230	280	40		50	9723240	3661589021175	0,80
230	280	60		50	9723260	3661589021182	0,68
230	280	80		50	9723280	3661589021199	0,58
230	280	100		50	9723210	3661589021113	0,58
230	280	120		50	9723212	3661589021120	0,58
230	280	150		50	9723215	3661589021137	0,58
230	280	180		50	9723218	3661589021144	0,58
230	280	220		50	9723222	3661589021151	0,58
230	280	40	C	15 lots de 8	PC.081	3510780020817	5,94
230	280	60	C	15 lots de 8	PC.086	3661589006301	4,95
230	280	80	C	15 lots de 8	PC.082	3510780020824	4,42
230	280	120	C	15 lots de 8	PC.083	3510780020831	3,84
230	280	40	BL	Lot de 4	PC.00	3510782230009	3,63
230	280	60	BL	Lot de 4	PC.01	3510782230016	3,47
230	280	80	BL	Lot de 4	PC.02	3510782230023	3,37
230	280	120	BL	Lot de 4	PC.03	3510782230030	3,37

PLÂTRE ET MATÉRIAUX TENDRES

CLASSIC

ABR.RL115.120.CJ ROULEAU PAPIER MUR ET PLAFOND



- Papier poids D.
- Liant double résine.

PLÂTRE, PEINTURE, VERNIS, MASTIC

A

					REF		€
115	25	40		1	11625.040	3510781162547	25,81
115	25	60		1	11625.060	3510781162561	24,93
115	25	80		1	11625.080	3510781162585	23,79
115	25	100		1	11625.100	3510781162516	23,79
115	25	120		1	11625.120	3510781162523	23,79
115	25	150		1	11625.150	3510781162554	23,79
115	25	180		1	11625.180	3510780103152	23,79
120	25	40		1	12625.040	3661589031334	27,15
120	25	60		1	12625.060	3661589021991	26,22
120	25	80		1	12625.080	3661589022004	25,05
120	25	100		1	12625.100	3661589022011	25,05
120	25	120		1	12625.120	3661589022028	25,05
120	25	150		1	12625.150	3661589031341	25,05
120	25	180		1	12625.180	3661589031358	25,05
115	5	40	A	Lot de 5	11605.040	3661589012876	10,82
115	5	60	A	Lot de 5	11605.060	3661589012883	8,52
115	5	80	A	Lot de 5	11605.080	3661589012890	7,30
115	5	100	A	Lot de 5	11605.100	3661589012906	7,62
115	5	120	A	Lot de 5	11605.120	3661589012913	7,62
115	5	150	A	Lot de 5	11605.150	3661589012920	7,62
115	5	180	A	Lot de 5	11605.180	3661589012937	7,62

PLÂTRE ET MATÉRIAUX TENDRES



ABR.D225.CJ

DISQUE VELCRO FINITION MUR ET PLAFOND

- Papier poids D.
- Liant double résine.

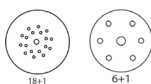

PLÂTRE, PEINTURE, VERNIS, MASTIC

A

Ø					REF		€
225	40	6+1		25	4423740	3661589031655	2,10
225	60	6+1		25	4423760	3661589031662	2,10
225	80	6+1		25	4423780	3661589031679	2,10
225	100	6+1		25	4423710	3661589031686	2,10
225	120	6+1		25	4423712	3661589031693	2,10
225	150	6+1		25	4423715	3661589031709	2,10
225	180	6+1		25	4423718	3661589064752	2,10
225	220	6+1		25	4423722	3661589031716	2,10
225	40	6+1	BL	Lot de 5	22507.01	3661589065476	12,40
225	60	6+1	BL	Lot de 5	22507.04	3661589065483	12,40
225	80	6+1	BL	Lot de 5	22507.02	3661589065490	12,40
225	100	6+1	BL	Lot de 5	22507.06	3661589065506	12,40
225	120	6+1	BL	Lot de 5	22507.03	3661589065513	12,40
225	150	6+1	BL	Lot de 5	22507.07	3661589065520	12,40
225	220	6+1	BL	Lot de 5	22507.08	3661589065537	12,40
225	40	18+1		25	4423040	3661589014887	2,10
225	60	18+1		25	4423060	3661589014894	2,10
225	80	18+1		25	4423080	3661589014900	2,10
225	100	18+1		25	4423010	3661589014863	2,10
225	120	18+1		25	4423012	3661589014870	2,10
225	150	18+1		25	4423015	3661589031631	2,10
225	180	18+1		25	4423018	3661589067531	2,10
225	220	18+1		25	4423022	3661589031648	2,10
225	40	18+1	BL	Lot de 5	22519.01	3661589065407	12,40
225	60	18+1	BL	Lot de 5	22519.04	3661589065414	12,40
225	80	18+1	BL	Lot de 5	22519.02	3661589065421	12,40
225	100	18+1	BL	Lot de 5	22519.06	3661589065438	12,40
225	120	18+1	BL	Lot de 5	22519.03	3661589065445	12,40
225	150	18+1	BL	Lot de 5	22519.07	3661589065452	12,40
225	220	18+1	BL	Lot de 5	22519.08	3661589065469	12,40

PLÂTRE ET MATÉRIAUX TENDRES

CLASSIC



ABR.TR290.CJ TRIANGLE VELCRO MUR ET PLAFOND

- Papier poids D.
- Liant double résine.



PLÂTRE, PEINTURE, VERNIS, MASTIC

A

Ø	12P	25	REF		€
290 x 290	12P	25	290.290.12.040	3661589036360	2,68
290 x 290	12P	25	290.290.12.060	3661589036377	2,68
290 x 290	12P	25	290.290.12.080	3661589036384	2,68
290 x 290	12P	25	290.290.12.120	3661589036391	2,68
290 x 290	12P	25	290.290.12.150	3661589036407	2,68
290 x 290	12P	25	290.290.12.220	3661589036414	2,68

CLASSIC



ABR.D225.TR DISQUE VELCRO TREILLIS MUR ET PLAFOND

- Treillis anti-encrassement.
- Liant double résine.



PLÂTRE, PEINTURE, VERNIS, MASTIC

CARBURE
SILICIUM

Ø				REF		€
225	60		25	4522560	3661589014931	2,73
225	80		25	4522580	3661589014948	2,73
225	100		25	4522510	3661589014917	2,73
225	120		25	4522512	3661589014924	2,73
225	150		25	4522515	3661589027467	2,73
225	60	BL	Lot de 5	22599.01	3661589065544	15,76
225	80	BL	Lot de 5	22599.02	3661589065551	15,76
225	100	BL	Lot de 5	22599.06	3661589065568	15,76
225	120	BL	Lot de 5	22599.03	3661589065575	15,76
225	150	BL	Lot de 5	22599.04	3661589065582	15,76

PLÂTRE ET MATÉRIAUX TENDRES

CLASSIC

ABR.P93.115.CJ

PATIN A PINCER MUR ET PLAFOND

- Papier poids D.
- Liant double résine.



PLÂTRE, PEINTURE, VERNIS, MASTIC

A

							REF		€
93	230	40	SP	A	15 lots de 12	93230.00.121	3510780001212	4,78	
93	230	80	SP	A	15 lots de 12	93230.00.122	3510780001229	4,15	
93	230	120	SP	A	15 lots de 12	93230.00.123	3510780001236	4,05	
93	230	40	SP	BL	Lot de 8	93230.00.01	3510789300019	4,83	
93	230	80	SP	BL	Lot de 8	93230.00.02	3510789300026	4,20	
93	230	120	SP	BL	Lot de 8	93230.00.03	3510789300033	4,05	
93	230	40	8P	A	15 lots de 12	93230.08.121	3510780081214	4,78	
93	230	80	8P	A	15 lots de 12	93230.08.122	3510780081221	4,15	
93	230	120	8P	A	15 lots de 12	93230.08.123	3510780081238	4,05	
93	230	40	8P	BL	Lot de 8	93230.08.01	3510789308015	6,15	
93	230	80	8P	BL	Lot de 8	93230.08.02	3510789308022	5,47	
93	230	120	8P	BL	Lot de 8	93230.08.03	3510789308039	5,31	
93	230	40	6+2	BL	Lot de 8	93230.62.01	3510789362017	6,15	
93	230	80	6+2	BL	Lot de 8	93230.62.02	3510789362024	5,47	
93	230	120	6+2	BL	Lot de 8	93230.62.03	3510789362031	5,31	
115	280	40	SP	A	15 lots de 12	115280.00.121	3510780011211	6,52	
115	280	80	SP	A	15 lots de 12	115280.00.122	3510780011228	5,42	
115	280	120	SP	A	15 lots de 12	115280.00.123	3510780011235	5,05	
115	280	40	SP	BL	Lot de 8	115280.00.01	3510781500011	6,15	
115	280	80	SP	BL	Lot de 8	115280.00.02	3510781500028	5,31	
115	280	120	SP	BL	Lot de 8	115280.00.03	3510781500035	5,10	
115	280	40	10P	A	15 lots de 12	115280.10.121	3510780101219	6,52	
115	280	80	10P	A	15 lots de 12	115280.10.122	3510780101226	5,42	
115	280	120	10P	A	15 lots de 12	115280.10.123	3510780101233	5,05	
115	280	40	10P	BL	Lot de 8	115280.10.01	3510781510010	7,52	
115	280	80	10P	BL	Lot de 8	115280.10.02	3510781510027	6,52	
115	280	120	10P	BL	Lot de 8	115280.10.03	3510781510034	6,36	

PLÂTRE ET MATÉRIAUX TENDRES

CLASSIC



ABR.PP93.115.CB PATIN A PINCER TREILLIS



- Treillis anti-encrassement.
- Liant double résine.

PLÂTRE, BOIS, PEINTURE, VERNIS, MASTIC

A

						REF		€
93	230	120	A	15 lots de 8	93230.81	3661589030689	10,35	
93	230	180	A	15 lots de 8	93230.82	3661589030696	10,35	
115	280	120	A	15 lots de 8	115280.81	3661589030702	15,61	
115	280	180	A	15 lots de 8	115280.82	3661589030719	15,61	

CLASSIC



ABR.BLOC BLOC A POIGNEE A PINCES



- Utilisable avec des abrasifs de 115 x 280 mm.

					REF		€
115	235	C	6	70235.115	3661589022608	8,52	

CLASSIC



ABR.CALE CALE A PONCER VELCRO



- Utilisable avec des abrasifs de 73 x 125 mm.

					REF		€
70	120	B	10	70120.20	3510780100427	7,42	

ACCESSOIRES

CLASSIC



ABR.PLA.UNI

PLATEAU VELCRO POUR PONCEUSE EXCENTRIQUE



- Plateau pour multi-ponceuses orbitales (sauf Metabo et Bosch).
- S'adapte sur tous les abrasifs de perforations : 6, 7, 9, 15 et 21 trous.
- Insert métallique de 5/16 et M8 (pour Makita et Festool).
- Haute résistance à la chaleur et aux pressions mécaniques.

Ø			REF		€
150	BL	1	8017099	3661589018892	63,67

CLASSIC



ABR.PLA.EX

PLATEAU VELCRO POUR PONCEUSE EXCENTRIQUE



- Plateau pour les ponceuses orbitales Bosch (Gex et Pex).
- Ø125 fixation 3 trous + 1 central à perforation 8 trous.
- Ø150 fixation par écrou central à perforation 6 trous.
- Haute résistance à la chaleur et aux pressions mécaniques.

Ø			REF		€
125	BL	1	8017010	3661589018878	28,63
150	BL	1	8017020	3661589018885	36,40

CLASSIC

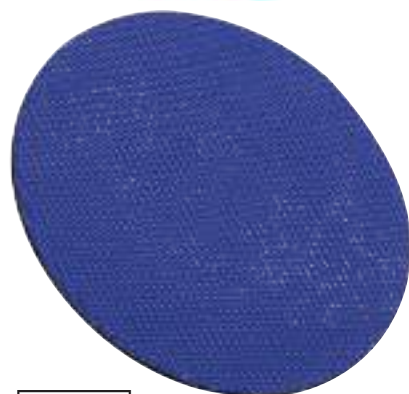

EN13743

ABR.PLA.M14V

PLATEAU VELCRO POUR MEULEUSE



Ø					REF		€
115	M14	13300	BL	1	117.16	3510780117166	8,94
125	M14	12500	BL	1	127.16	3510780127165	10,40
150	M14	8500	BL	1	157.16	3510780157162	15,24

ACCESSOIRES

CLASSIC



EN13743

ABR.PLA.T8
PLATEAU VELCRO TIGE 8MM



Ø	Grain	Speed	Color	Qty	REF	Image	€
115	8	4500	BL	1	118.16		3510780118163 9,52
125	8	4500	BL	1	128.16		3510780128162 10,40
150	8	3800	BL	1	158.16		3510780158169 15,24

CLASSIC



EN13743

ABR.PLA.M14
PLATEAU CAOUTCHOUC POUR MEULEUSE



Ø	Grain	Speed	Color	Qty	REF	Image	€
115	M14	20000	BL	1	117.06		3510780117067 8,52
125	M14	20000	BL	1	127.06		3510780127066 9,62
180	M14	10000	BL	1	187.06		3510780187060 14,09

CLASSIC



EN13743

ABR.PLA.T6
PLATEAU CAOUTCHOUC TIGE 6MM



Ø	Grain	Speed	Color	Qty	REF	Image	€
115	6	3250	BL	1	118.06		3510780118064 9,52
125	6	3250	BL	1	128.06		3510780128063 10,40

ACCESSOIRES

CLASSIC



ABR.POL.901

BONNET DE POLISSAGE VELCRO

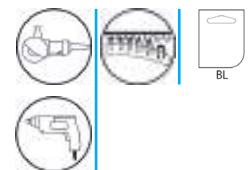

Ø	Color	Qty	REF	Barcode	€
125	BL	1	900.125	3661589012609	11,09

CLASSIC



ABR.POL.902

**BONNET DE POLISSAGE POUR
PLATEAU CAOUTCHOUC**



Ø	Color	Qty	REF	Barcode	€
140	BL	1	900.140	3661589012616	13,66

CLASSIC



ABR.POL.903

DISQUE A POLIR EN MOUSSE VELCRO





Ø	Color	Qty	REF	Barcode	€
125	BL	1	901.125	3661589012623	13,04





info@leman-sa.com

BROSSES

-  **BOIS MASSIF** **P. 384**
-  **MAÇONNERIE** **P. 390**
-  **MÉTAL** **P. 391**

CLASSIC  pour les travaux courants et polyvalents.

BOIS MASSIF

CLASSIC



BRO.00370
ROUE DE FINITION EN NYLON



DÉCAPAGE DOUX

- Ponçage de finition sur surface étroite.
- Toile non tissée.
- 4 500 tr/min maximum.

BOIS, MÉTAL

EN1083-2



Ø	LM	Ø	Ø	REF	Ø	Ø	Ø	€
75	6	28	10	370.01	BL	1	3510780113472	8,66
80	6	40	40	370.02	BL	1	3510780113489	9,83

CLASSIC



BRO.00380
ROUE DE FINITION MIXTE EN NYLON



DÉCAPAGE DOUX

- Ébavurage de finition sur surface étroite.
- Toile non tissée nylon et lamelles corindon.
- 4 500 tr/min maximum.

BOIS, MÉTAL

EN1083-2



Ø	LM	Ø	Ø	REF	Ø	Ø	Ø	€
40	6	35	20	380.01	BL	1	3510780113496	7,62

CLASSIC



BRO.00150
BROSSE FIL NYLON POUR POLISSEUSE



M14



DÉCAPAGE DOUX

- Enlèvement de peinture, vernis, rouille légère.
- Restauration du bois.
- Vitesse maximum d'utilisation de 2500 tr/min.

BOIS, MÉTAL

EN1083-2



Ø	Ø	Ø	REF	Ø	Ø	Ø	€
130	60	2500	150.125V	A	2	3661589026385	51,46
130	46	2500	150.126V	A	2	3661589043504	51,46

BOIS MASSIF

CLASSIC



BRO.00120
BROSSE PINCEAU FIL NYLON



DÉCAPAGE DOUX

- Nettoyage et polissage des bois et métaux non-ferreux.
- Idéal pour surface étroite, en coin et difficilement accessible.
- 4 500 tr/min maximum.

BOIS, MÉTAL

EN1083-2



CLASSIC



BRO.00130
BROSSE CONIQUE FIL NYLON



DÉCAPAGE DOUX

- Nettoyage et polissage des bois et métaux non-ferreux.
- Idéal pour surface plane.
- 4 500 tr/min maximum.

BOIS, MÉTAL

EN1083-2



CLASSIC



BRO.00140
BROSSE ÉVENTAIL FIL NYLON



DÉCAPAGE DOUX

- Nettoyage et polissage des bois et métaux non-ferreux.
- Idéal pour grillage métallique.
- 4 500 tr/min maximum.

BOIS, MÉTAL

EN1083-2



Ø	LM	REF	Icon 1	Icon 2	Icon 3	€			
100	6	30	23	80	140.101V	A	10	3510780111287	17,61
100	6	30	25	80	140.101	BL	1	3510781401011	19,53

BOIS MASSIF

CLASSIC



BRO.00110
BROSSE CIRCULAIRE FIL NYLON



DÉCAPAGE DOUX

- Nettoyage et polissage des bois et métaux non-ferreux.
- Idéal pour surface étroite et difficilement accessible.
- 4 500 tr/min maximum.

BOIS, MÉTAL

EN1083-2



Ø	LM	REF	BL	REF	€
50	6	30	5	80	110.051V A 10 3510780111126 7,51
50	6	30	5	80	110.051 BL 1 3510781100518 8,17
75	6	30	8	80	110.071V A 10 3510780111140 8,88
75	6	30	8	80	110.071 BL 1 3510781100716 9,93
100	6	30	8	80	110.101V A 10 3510780111188 10,15
100	6	30	8	80	110.101 BL 1 3510781101010 11,20

CLASSIC



BRO.00123
LOT DE 3 BROSSES FIL NYLON



DÉCAPAGE DOUX



75	6	30	Circulaire	x1
20	6	17	Pinceau	x1
50	6	30	Conique	x1

BOIS, MÉTAL

EN1083-2



BL	REF	€
BL 1	0123.01 3510780123013	24,16

BOIS MASSIF

CLASSIC



BRO.00620
BROSSE PINCEAU FIL LAITON ONDULÉ



DÉCAPAGE DOUX

- Nettoyage et polissage des métaux, cuivres et bois tendres.
- 4 500 tr/min maximum.

BOIS, MÉTAL

EN1083-2



REF



€

22	6	17	0,20	620.022	BL	1	3661589006479	5,91
----	---	----	------	----------------	----	---	---------------	------

CLASSIC



BRO.00610
BROSSE CONIQUE FIL LAITON ONDULÉ



DÉCAPAGE DOUX

- Nettoyage et polissage des métaux, cuivres et bois tendres.
- 4 500 tr/min maximum.

BOIS, MÉTAL

EN1083-2



REF



€

50	6	30	0,20	610.050	BL	1	3661589006493	6,57
75	6	30	0,20	610.075	BL	1	3661589006516	7,41

CLASSIC



BRO.00630
BROSSE CIRCULAIRE FIL LAITON ONDULÉ



DÉCAPAGE DOUX

- Nettoyage et polissage des métaux, cuivres et bois tendres.
- Idéal pour surface étroite et difficilement accessible.
- 4 500 tr/min maximum.

BOIS, MÉTAL

EN1083-2



REF



€

50	6	30	7	0,20	630.050	BL	1	3661589006417	5,47
75	6	30	10	0,20	630.075	BL	1	3661589006431	6,35
100	6	28	12	0,20	630.100	BL	1	3661589006455	6,90

BOIS MASSIF

CLASSIC



BRO.00640
LOT DE 3 BROSSES FIL LAITON ONDULÉ



DÉCAPAGE DOUX

EN1083-2



BL



75	6	30	Circulaire	x1
22	6	30	Pinceau	x1
50	6	30	Conique	x1

BOIS, MÉTAL



REF



€

BL	1	640.03	3661589006530	17,11
----	---	---------------	---------------	-------

CLASSIC



BRO.710.LA
BROSSE FIL LAITON EN BOIS FORME VIOLON



DÉCAPAGE DOUX

- Décapage, nettoyage et polissage de tous matériaux.



BOIS, MÉTAL



REF



€

150	710.204	B	8	3510787102042	8,17
-----	----------------	---	---	---------------	------

BOIS MASSIF

CLASSIC

BRO.740.NY BROSSE FIL NYLON MANCHE PLASTIQUE



DÉCAPAGE DOUX

- Décapage, nettoyage et polissage de tous matériaux.



BOIS, MÉTAL

		REF				€
140	0,25	740.206	B	15	3661589042873	4,25

CLASSIC

BRO.740.LA BROSSE FIL LAITON MANCHE PLASTIQUE



DÉCAPAGE DOUX

- Décapage, nettoyage et polissage de tous matériaux.



BOIS, MÉTAL

		REF				€
140	0,30	740.246	B	15	3510780103831	6,18

CLASSIC

BRO.720.LA BROSSE FIL LAITON MANCHE BOIS



DÉCAPAGE DOUX

- Décapage, nettoyage et polissage de tous matériaux.



BOIS, MÉTAL

		REF				€
145	0,30	720.294	B	15	3510780103848	5,13

CLASSIC





BRO.KIT.A
KIT DE RAMONAGE ACIER 7 MÈTRES



- 5 cannes de 1,40 m et 1 hérisson acier ø 250 mm.

BÉTON

Ø	REF			€
250	KIT250A	1	3661589022738	41,48

CLASSIC





BRO.07890
HÉRISSON ROND ACIER



- Pour le ramonage des conduits de cheminées.
- Fil acier plat.
- 1 embout fileté M12.
- + 1 anneau.

BÉTON

Ø	REF			€
150	7890.150	1	3661589022752	14,18
200	7890.200	1	3661589022769	15,62
250	7890.250	1	3661589022776	16,28



CLASSIC



BRO.07834
CANNE DE RAMONAGE



- Embout laiton filetage M12.

Ø		REF			€
20	1000	7834.20.100	1	3661589022868	20,80

MÉTAL

CLASSIC



BRO.07834.A
CANNE DE RAMONAGE SYSTÈME
AUTOBLOQUANT



- Embout laiton filetage M12.

Ø	Q	REF	Q	Q	€
18	1000	7834.18.100A	1	3661589022875	22,90

CLASSIC



BRO.07834.E
CANNE DE RAMONAGE ECO



- Embout laiton filetage M12.

Ø	Q	REF	Q	Q	€
17	1400	7834.17.140E	1	3661589022882	7,51

CLASSIC



BRO.KIT.N
KIT DE RAMONAGE NYLON 7 MÈTRES



- 5 cannes de 1,40 m et 1 hérisson synthétique ø 200 mm.

ACIER INOXYDABLE

Ø	REF	Q	Q	€
200	KIT200N	1	3661589022745	41,48

MÉTAL

CLASSIC





BRO.07894 HÉRISSON ROND NYLON



- Pour le ramonage des conduits inox de cheminées.
- Fil synthétique.
- 1 embout fileté M12.
- + 1 anneau.

ACIER INOXYDABLE

Ø	REF			€
150	7894.150	1	3661589030405	12,64
180	7894.180	1	3661589022837	13,03
200	7894.200	1	3661589022844	14,18
250	7894.250	1	3661589022851	15,50

CLASSIC





BRO.KITPEL.E KIT DE RAMONAGE SPÉCIAL POÊLE À GRANULES



- Canne fibre de verre.

ACIER INOXYDABLE

Ø		REF			€
80	2000	KITPELECO	1	3661589064776	46,34

CLASSIC





BRO.KITPEL.P KIT DE RAMONAGE PRO SPÉCIAL POÊLE À GRANULES



- Canne fibre de verre.
- Acier flexible & boule.

ACIER INOXYDABLE

Ø		REF			€
80	3000	KITPELPRO	1	3661589064783	82,74

MÉTAL

CLASSIC



BRO.00320

BROSSE PINCEAU FIL ACIER ONDULÉ

DÉCAPAGE DUR

- Ébavurage et nettoyage des métaux et bois.
- Idéal pour surface étroite, en coin et difficilement accessible.
- 4 500 tr/min maximum.



BOIS, MÉTAL



EN1083-2



Ø	LM	REF	Holder	Q	Barcode	€		
25	6	17	0,30	320.025V	A	10	3510780110877	3,59
25	6	17	0,30	320.025A	BL	1	3510780111584	3,93

CLASSIC



BRO.00330

BROSSE CIRCULAIRE FIL ACIER ONDULÉ

DÉCAPAGE DUR

- Ébavurage et nettoyage des métaux et bois.
- Idéal pour surface étroite et difficilement accessible.
- 4 500 tr/min maximum.



BOIS, MÉTAL

EN1083-2



Ø	LM	REF	Holder	Q	Barcode	€			
40	6	30	4	0,30	330.040A	BL	1	3510780111591	2,88
50	6	30	7	0,30	330.050V	A	10	3510780110891	3,21
50	6	30	7	0,30	330.050A	BL	1	3510780111614	3,59
75	6	30	10	0,30	330.075V	A	10	3510780110907	3,59
75	6	30	9	0,30	330.075A	BL	1	3510780111621	3,93
100	6	30	12	0,30	330.100V	A	10	3510780110914	3,75
100	6	30	9	0,30	330.100A	BL	1	3510780111638	4,14

MÉTAL

CLASSIC



BRO.00310
BROSSE CONIQUE FIL ACIER ONDULÉ



DÉCAPAGE DUR

- Ébavurage et nettoyage des métaux et bois.
- Idéal pour surface plane.
- 4 500 tr/min maximum.

BOIS, MÉTAL

EN1083-2



Ø	LM	REF	Icon 1	Icon 2	Icon 3	€		
50	6	30	0,30	310.050V	A	10	3510780110846	3,32
50	6	30	0,30	310.050A	BL	1	3510780111553	3,75
75	6	30	0,30	310.075V	A	10	3510780110853	3,48
75	6	30	0,30	310.075A	BL	1	3510780111560	4,03

CLASSIC



BRO.103020
LOT DE 3 BROSSES FIL ACIER ONDULÉ



DÉCAPAGE DUR

EN1083-2



Ø	LM	Forme	Quantité
75	6	30	Circulaire x1
25	6	17	Pinceau x1
50	6	30	Conique x1

BOIS, MÉTAL

Icon 1	Icon 2	REF	Icon 3	€
BL	1	103020.02	3510780113915	10,15

MÉTAL

CLASSIC



BRO.00330.I
BROSSE CIRCULAIRE FIL INOX ONDULÉ



DÉCAPAGE DUR

- Ébavurage et nettoyage de tous métaux sans trace de rouille.
- Idéal pour surface étroite et difficilement accessible.
- 4 500 tr/min maximum.

MÉTAL, ACIER INOXYDABLE

EN1083-2



Ø	LM	REF	BL	€					
75	6	30	9	0,30	330.075I	BL	1	3510780114417	7,56
100	6	30	9	0,30	330.100I	BL	1	3510780114424	9,38

CLASSIC



BRO.00320.I
BROSSE PINCEAU FIL INOX ONDULÉ



DÉCAPAGE DUR

- Ébavurage et nettoyage de tous métaux sans trace de rouille.
- Idéal pour surface étroite, en coin et difficilement accessible.
- 4 500 tr/min maximum.

MÉTAL, ACIER INOXYDABLE

EN1083-2



Ø	LM	REF	BL	€				
22	6	17	0,30	320.022I	BL	1	3510780113984	7,07

CLASSIC



BRO.00310.I
BROSSE CONIQUE FIL INOX ONDULÉ



DÉCAPAGE DUR

- Ébavurage et nettoyage de tous métaux sans trace de rouille.
- Idéal pour surface plane.
- 4 500 tr/min maximum.

MÉTAL, ACIER INOXYDABLE

EN1083-2



Ø	LM	REF	BL	€				
50	6	30	0,30	310.050I	BL	1	3510780114431	7,46
75	6	30	0,30	310.075I	BL	1	3510780114448	9,88

MÉTAL

CLASSIC



BRO.00210

BROSSE CIRCULAIRE FIL ACIER TORSADÉ

DÉCAPAGE EXTRA DUR

- Ébavurage, enlèvement de laque, de rouille et des cordons de soudure.
- Pour un nettoyage agressif.



MÉTAL, SOUDURE

EN1083-2



Ø	LM	REF	€					
70	6	30	0,50	210.070V	A	10	3510780110822	9,38
70	6	30	0,50	210.070	BL	1	3510782100708	10,15

CLASSIC



BRO.00220

BROSSE CONIQUE FIL ACIER TORSADÉ

DÉCAPAGE EXTRA DUR

- Ébavurage, enlèvement de laque, de rouille et des cordons de soudure.
- Pour un nettoyage agressif.



MÉTAL, SOUDURE



Ø	LM	REF	€					
70	6	30	0,50	220.070V	A	10	3510780110839	10,65
70	6	30	0,50	220.070	BL	1	3510782200705	11,81

CLASSIC



BRO.00420

BROSSE CIRCULAIRE FIL ACIER TORSADÉ

DÉCAPAGE EXTRA DUR

- Ébavurage, enlèvement de laque, de rouille et des cordons de soudure.
- Pour un nettoyage agressif sur surface étroite et difficilement accessible.



MÉTAL, SOUDURE



Ø	REF	€							
125	22,2	13	0,50	6500	420.125	BL	1	3510784201502	24,00
178	22,2	13	0,50	4500	420.180	BL	1	3510784202004	33,23

MÉTAL

CLASSIC



BRO.00530
BROSSE CONIQUE FIL ACIER TORSADÉ

DÉCAPAGE EXTRA DUR

- Ébavurage, enlèvement de laque, de rouille et des cordons de soudure.
- Pour un nettoyage agressif sur surface plane.



M14



MÉTAL, SOUDURE

EN1083-2



Ø	mm	mm	REF	BL	A	REF	€
65	0,50	12500	530.065V	A	4	3510780110983	13,85
65	0,50	12500	530.065	BL	1	3510785300655	15,94
80	0,50	8500	530.080V	A	4	3510780110990	19,25
80	0,50	8500	530.080	BL	1	3510785300808	22,06
100	0,50	8500	530.100V	A	4	3510780111027	23,78
100	0,50	8500	530.100	BL	1	3510785301003	28,08

CLASSIC



BRO.00510
BROSSE CUVETTE FIL ACIER TORSADÉ

DÉCAPAGE EXTRA DUR

- Ébavurage, enlèvement de laque, de rouille et des cordons de soudure.
- Pour un nettoyage agressif sur surface étroite et difficilement accessible.



M14



MÉTAL, SOUDURE

EN1083-2



Ø	mm	mm	REF	BL	A	REF	€
100	0,35	12500	510.035V	A	4	3510780110921	11,09
100	0,35	12500	510.035	BL	1	3661589044563	12,14
100	0,50	12500	510.050V	A	4	3510780110938	10,32
100	0,50	12500	510.050	BL	1	3661589044570	10,87
115	0,35	12500	510.535V	A	4	3510780110945	11,81
100	0,35	12500	510.535	BL	1	3510785105359	13,52
115	0,50	12500	510.550V	A	4	3510780110952	10,87
115	0,50	12500	510.550	BL	1	3510785105502	12,14

MÉTAL

CLASSIC



EN1083-2



BRO.00540
BROSSE CONIQUE FIL ACIER ONDULÉ



DÉCAPAGE DUR

- Ébavurage, enlèvement de laque et de rouille.
- Pour un nettoyage léger et moyen, sur surface plane.

MÉTAL

Ø	Grain	Spine	REF	Icon 1	Icon 2	Icon 3	€
60	0,30	12500	540.060V	A	4	3510780111041	7,51
60	0,30	12500	540.060	BL	1	3661589044549	8,66
80	0,30	8500	540.080V	A	4	3510780111058	8,07
80	0,30	8500	540.080	BL	1	3510785400805	8,78
100	0,30	8500	540.100V	A	4	3510780111065	11,86
100	0,30	8500	540.100	BL	1	3510785401000	13,52
125	0,30	6500	540.125V	B	3	3510780111072	16,77
125	0,30	6500	540.125	BL	1	3510785401253	19,53
150	0,30	4500	540.150V	B	3	3510780111089	20,30
150	0,30	4500	540.150	BL	1	3661589044556	24,49

CLASSIC



EN1083-2



BRO.00520
BROSSE CUVETTE FIL ACIER ONDULÉ



DÉCAPAGE DUR

- Ébavurage, enlèvement de laque et de rouille.
- Pour un nettoyage léger et moyen, sur surface étroite et difficilement accessible.

MÉTAL

Ø	Grain	Spine	REF	Icon 1	Icon 2	Icon 3	€
100	0,30	12500	520.100V	A	4	3510780110969	9,10
100	0,30	12500	520.100	BL	1	3510785201006	9,83
115	0,30	12500	520.115V	A	4	3510780110976	9,99
115	0,30	12500	520.115	BL	1	3510785201150	10,87

MÉTAL



BRO.00410
BROSSE CIRCULAIRE FIL ACIER ONDULÉ
POUR TOURET



DÉCAPAGE DUR

- Ébavurage et nettoyage sur tous types de métaux.
- Usage intensif.
- Livrée avec bagues d'adaptation.

MÉTAL

EN1083-2



Ø	Ø	Ø	Ø	REF	Icon 1	Icon 2	Icon 3	€
125	16	20	0,20	410.125	BL	1	3510784101253	15,94
150	16/20/25	20	0,30	410.150	BL	1	3510780100533	20,20
200	16/20/25	25	0,30	410.200	BL	1	3510780100540	26,92

CLASSIC



BRO.00523
LOT DE 3 BROSSES FIL ACIER



M14



DÉCAPAGE DUR ET EXTRA DUR

EN1083-2



Ø	Forme	Qté
100	Conique/Ondulé	x1
100	Cuvette/Torsadé	x1
100	Cuvette/Ondulé	x1

MÉTAL

Icon 1	Icon 2	REF	Icon 3	€
BL	1	523.03	3510780523035	30,62

CLASSIC



BRO.00760
BROSSE FIL ACIER LAITONNÉ MANCHE
PLASTIQUE FORME RABOT



DÉCAPAGE DUR

- Pour le nettoyage ou décapage des bois et métaux.
- Confort d'utilisation.
- Fil acier laitonné ondulé.

BOIS, MÉTAL

Icon 1	Icon 2	REF	Icon 3	Icon 4	Icon 5	€
240	0,30	760.192	B	6	3510780113502	7,18

MÉTAL

CLASSIC



BRO.740.AL
BROSSE FIL ACIER LAITONNÉ MANCHE PLASTIQUE



DÉCAPAGE DUR

- Décapage, nettoyage et polissage de tous matériaux.

BOIS, MÉTAL

		REF				€
140	0,30	740.216	B	15	3510787402166	3,21

CLASSIC



BRO.740.AC
BROSSE FIL ACIER MANCHE PLASTIQUE



DÉCAPAGE DUR

- Décapage, nettoyage et polissage de tous matériaux.

BOIS, MÉTAL

		REF				€
140	0,30	740.226	B	15	3510787402265	2,88

CLASSIC



BRO.740.IN
BROSSE FIL INOX MANCHE PLASTIQUE



DÉCAPAGE DUR

- Décapage, nettoyage et polissage de tous matériaux.

MÉTAL, ACIER INOXYDABLE

		REF				€
140	0,30	740.236	B	15	3510787402364	6,18

MÉTAL

CLASSIC



BRO.720.AL
BROSSE FIL ACIER LAITONNÉ MANCHE BOIS



DÉCAPAGE DUR

- Décapage, nettoyage et polissage de tous matériaux.

BOIS, MÉTAL

		REF				€
145	0,30	720.291	B	15	3510787202919	3,65

CLASSIC



BRO.720.AC
BROSSE FIL ACIER MANCHE BOIS



DÉCAPAGE DUR

- Décapage, nettoyage et polissage de tous matériaux.

BOIS, MÉTAL

		REF				€
145	0,35	720.292	B	15	3510787202926	3,32

CLASSIC



BRO.720.IN
BROSSE FIL INOX MANCHE BOIS



DÉCAPAGE DUR

- Décapage, nettoyage et polissage de tous matériaux.

MÉTAL, ACIER INOXYDABLE

		REF				€
145	0,30	720.293	B	15	3510787202933	5,13

MÉTAL

CLASSIC



BRO.750.AC





**BROSSE FIL ACIER EN V MANCHE BOIS
SPÉCIAL SOUDURE**

DÉCAPAGE DUR

- Idéal pour le décapage des cordons de soudure.
- Fils plats.



MÉTAL, SOUDURE

		REF				€
145	0,35	750.232	A	8	3510780104555	8,66

CLASSIC



BRO.750.IN





**BROSSE FIL INOX EN V MANCHE BOIS
SPÉCIAL SOUDURE**

DÉCAPAGE DUR

- Idéal pour le décapage des cordons de soudure.
- Fils plats.



MÉTAL, ACIER INOXYDABLE, SOUDURE

		REF				€
145	0,35	750.233	A	8	3510780104562	14,08

CLASSIC







BRO.07150

**BROSSE FIL AICER LAITONNÉ MANCHE
BOIS BOUGIE**

DÉCAPAGE DUR



MÉTAL

		REF				€
45	0,20	7150.180	A	15	3510787150180	1,68

MÉTAL



BRO.710.AL
BROSSE FIL ACIER LAITONNÉ EN BOIS
FORME VIOLON
DÉCAPAGE DUR

- Décapage, nettoyage et polissage de tous matériaux.

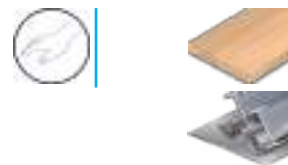

BOIS, MÉTAL

		REF				€
170	0,30	710.201	B	8	3510787102011	4,59



BRO.710.AC
BROSSE FIL ACIER EN BOIS FORME VIOLON
DÉCAPAGE DUR

- Décapage, nettoyage et polissage de tous matériaux.

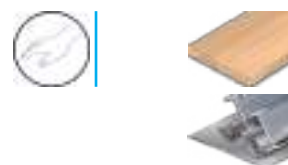

BOIS, MÉTAL

		REF				€
170	0,35	710.202	B	8	3510787102028	4,37



BRO.710.IN
BROSSE FIL INOX EN BOIS FORME VIOLON
DÉCAPAGE DUR

- Décapage, nettoyage et polissage de tous matériaux.



MÉTAL, ACIER INOXYDABLE

		REF				€
170	0,35	710.203	B	8	3510787102035	8,17

MÉTAL



BRO.00710
LOT DE 3 BROSSES FIL ACIER LAITONNÉ
MANCHE BOIS

DÉCAPAGE DUR



BOIS, MÉTAL

		REF		€
C	10	710.03	3510780710039	10,05



BRO.00360
PÂTE À POLIR

LUSTRAGE

- À charger sur sisal pour le polissage des métaux.



MÉTAL

			REF			€
30	20	320 - Blanc 800 - Bleu	360.02	BL	3510780113458	13,08



BRO.00350
SISAL CIRCULAIRE EN COTON

LUSTRAGE

- À charger de pâte abrasive, semi-finition des métaux.
- Surface plane.
- 4 500 tr/min maximum.



MÉTAL

EN1083-2



			REF				€
100	6	28	350.01	BL	1	3510780113441	11,92





info@leman-sa.com

MULTI-TOOLS

-  **PLÂTRE ET MATÉRIAUX TENDRES** P. 408
-  **MAÇONNERIE** P. 410
-  **PANNEAUX & DÉRIVÉS DU BOIS** P. 411
-  **MULTI-MATÉRIAUX** P. 412

CLASSIC  pour les travaux courants et polyvalents.



PLÂTRE ET MATÉRIAUX TENDRES



MUL.04001 LAME DE SCIE PLONGEANTE CHROME VANADIUM

- Lame fine de précision.
- Coupe plongante.



BOIS, PLÂTRE, PVC

			REF		€
	10	28	4001.01	3661589063014	5,00

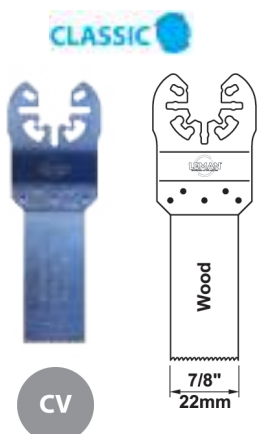

MUL.04002 LAME DE SCIE PLONGEANTE CHROME VANADIUM

- Lame fine de précision.
- Coupe plongante.



BOIS, PLÂTRE, PVC

			REF		€
	22	48	4002.01	3661589063021	5,68

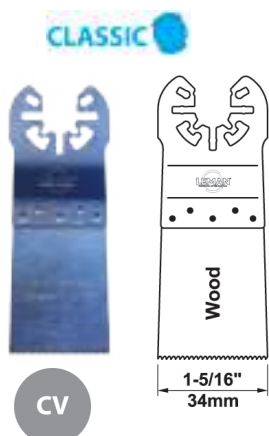

MUL.04003 LAME DE SCIE PLONGEANTE CHROME VANADIUM

- Lame fine de précision.
- Coupe plongante.



BOIS, PLÂTRE, PVC

			REF		€
	34	40	4003.01	3661589063038	5,10

PLÂTRE ET MATÉRIaux TENDRES

CLASSIC



CV

MUL.04008 LAME DE SCIE SEGMENT CHROME VANADIUM

- Sciage et coupe.
- Idéal en coupe arasante.

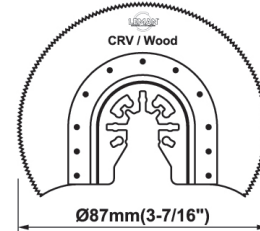

BOIS, PLÂTRE, PVC

Ø	REF	Icon	€
87	4008.01	3661589063083	7,67

CLASSIC



A

MUL.04021 LOT DE 10 PATINS ABRASIFS TRIANGULAIRES

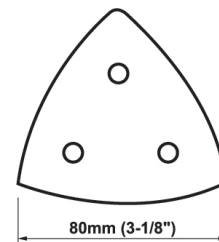

BOIS

Icon 1	Icon 2	Icon 3	REF	Icon 4	€
80	80	60	402110.01	3661589063212	4,89
80	80	80	402110.02	3661589063229	4,89
80	80	120	402110.03	3661589063243	4,89
80	80	60/80/120	402110.05	3661589063236	4,89

CLASSIC



MUL.04020 PLATEAU DE PONÇAGE AUTO-AGRIPPANT

- Ponçage.

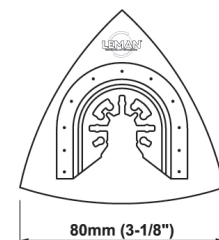

Icon 1	Icon 2	REF	Icon 3	€
80	80	4020.01	3661589063205	10,40

MAÇONNERIE

CLASSIC



DIAMANT

MUL.04019 PLATEAU DE PONÇAGE DIAMANTÉ

- Fraisage.



MORTIER CIMENT, BÉTON, BOIS, PIERRE

		REF		€
80	80	4019.01	3661589063199	12,48

CLASSIC



ACIER AU CARBONE
MÉTAUX

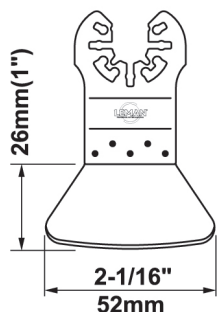

MUL.04011 SPATULE RIGIDE ACIER CARBONE

- Enlèvement de reste de colles et mortiers.



		REF		€
52	26	4011.01	3661589063113	4,89

CLASSIC



HM

MUL.04016 LAME DE SCIE SEGMENT FIN À CONCRÉTION CARBURE

- Déjointoiement de carrelage.
- Fraisage de fentes.

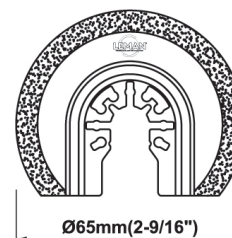

MATÉRIAUX BASE CIMENT, MORTIER CIMENT

	REF		€
65	4016.01	3661589063168	9,52

PANNEAUX ET DÉRIVÉS DU BOIS



MUL.4032DJ

LAME DE SCIE PLONGEANTE DENTURE JAPONAISE BI-MÉTAL

- Coupe plongeante.



BOIS, PARQUET, MDF/HDF, PVC

		REF		€
32	40	4032DJ.01	3661589084767	9,35

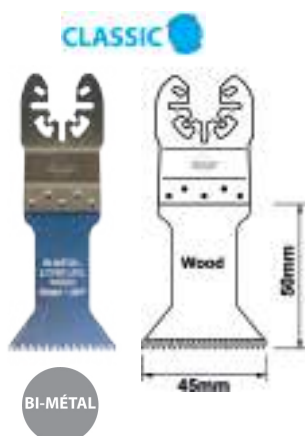

MUL.4045DJ

LAME DE SCIE PLONGEANTE DENTURE JAPONAISE BI-MÉTAL

- Coupe plongeante.

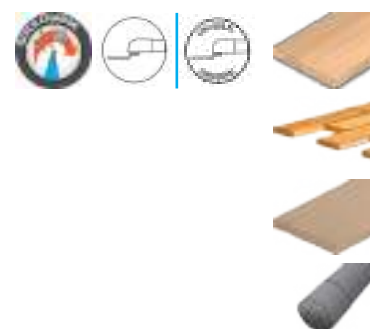

BOIS, PARQUET, MDF/HDF, PVC

		REF		€
45	50	4045DJ.01	3661589084774	13,24

MULTI-MATÉRIAUX



BI-MÉTAL

MUL.04004 LAME DE SCIE PLONGEANTE BI-MÉTAL

- Coupe plongeante ou arasante.

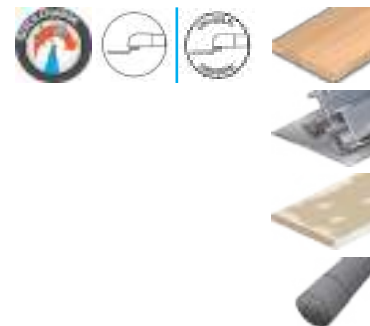

BOIS, MÉTAL, PLÂTRE, PVC

		REF		€
65	40	4004.01	3661589063045	10,99



BI-MÉTAL

MUL.04005 LAME DE SCIE PLONGEANTE BI-MÉTAL

- Coupe plongeante ou arasante.

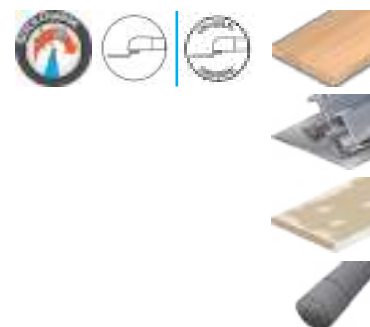

BOIS, MÉTAL, PLÂTRE, PVC

		REF		€
10	28	4005.01	3661589063052	7,30

MULTI-MATÉRIAUX

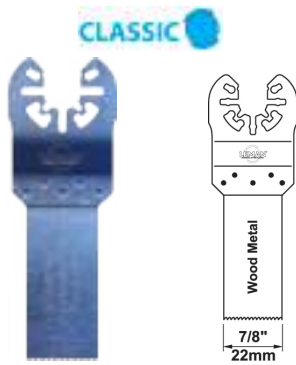

BI-MÉTAL

MUL.04006 LAME DE SCIE PLONGEANTE BI-MÉTAL



- Coupe plongeante ou arasante.

BOIS, MÉTAL, PLÂTRE, PVC

		REF		€
22	48	4006.01	3661589063069	8,10

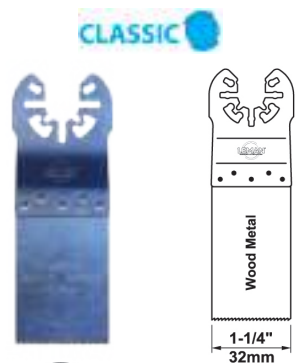

BI-MÉTAL

MUL.04007 LAME DE SCIE PLONGEANTE BI-MÉTAL



- Coupe plongeante ou arasante.

BOIS, MÉTAL, PLÂTRE, PVC

		REF		€
32	40	4007.01	3661589063076	9,04



ACIER AU CARBONE
MÉTAUX

MUL.04010 SPATULE FLEXIBLE ACIER CARBONE



- Enlèvement de reste de colles, peinture et joints silicone.

		REF		€
52	45	4010.01	3661589063106	4,42

MULTI-MATÉRIAUX



BI-MÉTAL

MUL.04009

LAME DE SCIE SEGMENT MOYEU DÉPORTÉ BI-MÉTAL

- Coupe plongeante.
- Idéal en coupe arasante.



BOIS, MÉTAL, PLÂTRE, PVC

Ø	REF	Icon	€
87	4009.01	3661589063090	11,93



HM

MUL.04014

LAME DE SCIE PLONGEANTE À CONCRÉTION CARBURE

- Coupe plongeante, grattage ou limage.
- Déjointoiement de carrelage.



CARRELAGE, FIBRE DE VERRE

Icon	Icon	REF	Icon	€
20	30	4014.01	3661589063144	7,52



DIAMANT

MUL.04018

LAME DE SCIE SEGMENT DIAMANTÉE

- Déjointoiement de carrelage.
- Fraisage de fentes.

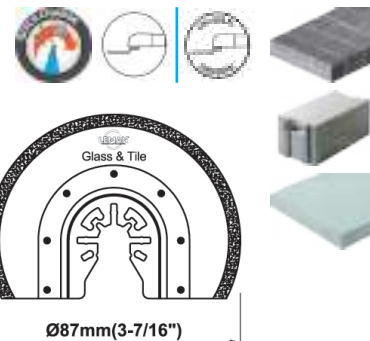

MATÉRIAUX BASE CIMENT, MORTIER CIMENT, REVÊTEMENT ÉPOXY, FIBRE DE VERRE

Ø	REF	Icon	€
87	4018.01	3661589063182	17,49

MULTI-MATÉRIAUX



MUL.4500.12
COFFRET 12 ACCESSOIRES
MULTI-MATÉRIAUX



REF		€
4500.12	3661589063274	68,19

BOIS, MÉTAL, PLÂTRE, PVC



- 1 plateau de ponçage à concrétion carbure (MUL.04019)
- 1 lame de scie segment moyen déporté Bi-métal (MUL.04009)
- 1 lame de scie segment à concrétion carbure (MUL.04016)
- 1 spatule rigide acier carbone (MUL.04011)
- 1 lame de scie plongeante bi-métal (MUL.04007)
- 1 lame de scie plongeante chrome vanadium (MUL.04003)
- 1 plateau de ponçage corindon (MUL.04020)
- 5 feuilles abrasives : 2x Gr 60 - 1 x Gr 80 - 2 x Gr 120 (MUL.04021)



MUL.4501.04
COFFRET 4 ACCESSOIRES
MULTI-MATÉRIAUX



REF		€
4501.04	3661589063267	25,43

BOIS, MÉTAL, PLÂTRE, PVC

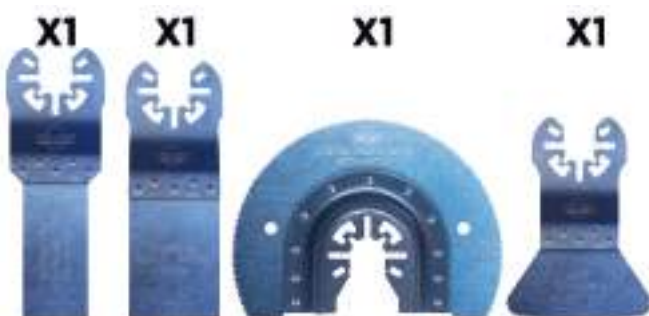

- 1 lame de scie plongeante Bi-métal (MUL.04006)
- 1 lame de scie plongeante Bi-métal (MUL.04007)
- 1 lame de scie segment moyen déporté Bi-métal (MUL.04009)
- 1 spatule rigide acier carbone (MUL.04011)



info@leman-sa.com

VISSAGE

EMBOUTS DE VISSAGE

P. 418

PORTE-EMBOUTS

P. 424

COFFRETS

P. 425

CLASSIC  pour les travaux courants et polyvalents.

 **WorkHardWorkFine**



ACCESSOIRES

CLASSIC

VIS.05110

EMBOUT DE VISSAGE SÉRIE COURTE 1/4" - PHILLIPS®



				REF		€
PH N°1	25	VR	15 mini	51101	3510785421213	0,77
PH N°1	25	BL	2	51101.02	3510785100552	2,22
PH N°2	25	VR	15 mini	51102	3510785420827	0,77
PH N°2	25	BL	2	51102.02	3510785100569	2,22
PH N°2	25	BL	10	51102.10	3510785100866	8,82
PH N°2	25	BL	25	51102.25	3510785100309	21,97
PH N°3	25	VR	15 mini	51103	3510785421206	0,77
PH N°3	25	BL	2	51103.02	3510785100576	2,22

CLASSIC

VIS.05410

EMBOUT DE VISSAGE SÉRIE LONGUE 1/4" - PHILLIPS®



				REF		€
PH N°1	50	VR	15 mini	54101	3510785421268	2,93
PH N°1	50	BL	2	54101.02	3510785100583	6,93
PH N°2	50	VR	15 mini	54102	3510785420933	2,93
PH N°2	50	BL	2	54102.02	3510785100590	6,93
PH N°2	90	VR	15 mini	54122	3510784096382	9,09
PH N°2	110	VR	15 mini	54132	3510784096405	9,90
PH N°2	150	VR	15 mini	54152	3510784096412	12,23
PH N°3	50	VR	15 mini	54103	3510785421244	2,93
PH N°3	50	BL	2	54103.02	3510785100613	6,93

CLASSIC

VIS.00510

EMBOUT DE VISSAGE SÉRIE 1/4" - FENTE



				REF		€
0,6 x 4,5	25	VR	15 mini	51016	3510784096085	1,47
0,8 x 5,5	25	VR	15 mini	51017	3510784096092	1,47
1,2 x 6,5	25	VR	15 mini	51019	3510784096108	1,47
1,6 x 8,0	25	VR	15 mini	51021	3510784096115	1,47

ACCESSOIRES

CLASSIC

VIS.05120

EMBOUT DE VISSAGE SÉRIE COURTE 1/4" - POZIDRIV®



				REF		€
PZ N°1	25	VR	15 mini	51201	3510785421008	0,77
PZ N°1	25	BL	2	51201.02	3510785100637	2,22
PZ N°2	25	VR	15 mini	51202	3510785420780	0,77
PZ N°2	25	BL	2	51202.02	3510785100651	2,22
PZ N°2	25	BL	10	51202.10	3510785100675	8,82
PZ N°2	25	BL	25	51202.25	3510785100361	21,97
PZ N°3	25	VR	15 mini	51203	3510785420964	0,77
PZ N°3	25	BL	2	51203.02	3510785100682	2,22

CLASSIC

VIS.05420

EMBOUT DE VISSAGE SÉRIE LONGUE 1/4" - POZIDRIV®



				REF		€
PZ N°1	50	VR	15 mini	54201	3510785421152	2,93
PZ N°1	50	BL	2	54201.02	3510785100705	6,93
PZ N°2	50	VR	15 mini	54202	3510785420971	2,93
PZ N°2	50	BL	2	54202.02	3510785100729	6,93
PZ N°2	90	VR	15 mini	54222	3510784096467	8,07
PZ N°2	110	VR	15 mini	54232	3510784096481	8,28
PZ N°2	150	VR	15 mini	54252	3510785416639	12,23
PZ N°3	50	VR	15 mini	54203	3510785421114	2,93
PZ N°3	50	BL	2	54203.02	3510785100750	6,93

CLASSIC

VIS.00514

EMBOUT DE VISSAGE SÉRIE 1/4" - CARRÉ



				REF		€
N°1	25	VR	15 mini	51401	3510784096191	2,27
N°1	25	BL	2	51401.02	3510785101436	5,25
N°2	25	VR	15 mini	51402	3510784096207	2,27
N°2	25	BL	2	51402.02	3510785101450	5,25
N°3	25	VR	15 mini	51403	3510784096214	2,27
N°3	25	BL	2	51403.02	3510785101474	5,25

ACCESSOIRES

CLASSIC

VIS.00515

EMBOUT DE VISSAGE SÉRIE COURTE 1/4" - TORX®



				REF		€
T10	25	VR	15 mini	51505	3510785421046	1,52
T10	25	BL	2	51505.02	3510785100491	3,58
T15	25	VR	15 mini	51506	3510785420995	1,52
T15	25	BL	2	51506.02	3510785100231	3,58
T20	25	VR	15 mini	51507	3510785420872	1,52
T20	25	BL	2	51507.02	3510785100248	3,58
T25	25	VR	15 mini	51508	3510785420865	1,52
T25	25	BL	2	51508.02	3510785100255	3,58
T30	25	VR	15 mini	51510	3510785420841	1,52
T30	25	BL	2	51510.02	3510785100262	3,58
T40	25	VR	15 mini	51511	3510784096283	1,52
T40	25	BL	2	51511.02	3510785100507	3,58

CLASSIC

VIS.00545

EMBOUT DE VISSAGE SÉRIE LONGUE 1/4" - TORX®



				REF		€
T10	50	VR	15 mini	54505	3510784096559	2,71
T15	50	VR	15 mini	54506	3510784096566	2,71
T20	50	VR	15 mini	54507	3510784096573	2,71
T25	50	VR	15 mini	54508	3510784096580	3,14
T30	50	VR	15 mini	54510	3510784096597	3,14
T40	50	VR	15 mini	54511	3510784096603	3,14

CLASSIC

VIS.05130

EMBOUT DE VISSAGE SÉRIE 1/4" - 6 PANS



				REF		€
2	25	VR	15 mini	51301	3510784096122	1,95
2,5	25	VR	15 mini	51302	3510784096139	1,95
3	25	VR	15 mini	51303	3510784096146	1,95
4	25	VR	15 mini	51304	3510784096153	1,95
5	25	VR	15 mini	51305	3510784096160	1,95
6	25	VR	15 mini	51306	3510784096177	1,95
8	25	VR	15 mini	51307	3510784096184	2,08

ACCESSOIRES

CLASSIC

VIS.00515.TR

EMBOUT DE VISSAGE SÉRIE 1/4" - TORX® PERCÉ



				REF		€
T10	25	VR	15 mini	51505TR	3510785421343	2,60
T15	25	VR	15 mini	51506TR	3510785421282	2,60
T15	25	BL	2	51506TR.02	3510785101207	5,31
T20	25	VR	15 mini	51507TR	3510785421169	2,60
T20	25	BL	2	51507TR.02	3510785100521	5,31
T25	25	VR	15 mini	51508TR	3510785421275	2,60
T25	25	BL	2	51508TR.02	3510785100538	5,31
T30	25	VR	15 mini	51510TR	3510785421183	2,60
T30	25	BL	2	51510TR.02	3510785100545	5,31
T40	25	VR	15 mini	51511TR	3510785421299	2,60

CLASSIC

VIS.05900

EMBOUT DE VISSAGE SÉRIE 1/4" - DOUILLE 6 PANS



				REF		€
6	50	VR	15 mini	59003	3510784096856	7,05
6	50	BL	1	59003.01	3510785101580	8,71
7	50	VR	15 mini	59004	3510784096863	7,05
7	50	BL	1	59004.01	3510785101597	8,71
8	50	VR	15 mini	59005	3510785420834	7,05
8	50	BL	1	59005.01	3510785100774	8,71
10	50	VR	15 mini	59006	3510785420803	7,96
10	50	BL	1	59006.01	3510785100781	9,79
11	50	VR	15 mini	59021	3510785421121	9,04
11	50	BL	1	59021.01	3510785101603	10,67
12	50	VR	15 mini	59022	3510785420988	9,48
12	50	BL	1	59022.01	3510785101610	11,26
13	50	VR	15 mini	59007	3510785420889	9,90
13	50	BL	1	59007.01	3510785100798	11,59

ACCESSOIRES

CLASSIC

VIS.05110.IMP

EMBOUT DE VISSAGE SÉRIE 1/4" - PHILLIPS® IMPACT



				REF		€
PH N°1	25	VR	15 mini	51101IMP	3661589065674	1,03
PH N°1	25	BL	2	51101IMP.02	3661589065681	3,14
PH N°2	25	VR	15 mini	51102IMP	3661589065698	1,03
PH N°2	25	BL	2	51102IMP.02	3661589065704	3,14
PH N°3	25	VR	15 mini	51103IMP	3661589065711	1,03
PH N°3	25	BL	2	51103IMP.02	3661589065728	3,14

CLASSIC

VIS.05120.IMP

EMBOUT DE VISSAGE SÉRIE 1/4" - POZIDRIV® IMPACT



				REF		€
PZ N°1	25	VR	15 mini	51201IMP	3661589065735	1,03
PZ N°1	25	BL	2	51201IMP.02	3661589065742	3,14
PZ N°2	25	VR	15 mini	51202IMP	3661589065759	1,03
PZ N°2	25	BL	2	51202IMP.02	3661589065766	3,14
PZ N°3	25	VR	15 mini	51203IMP	3661589065773	1,03
PZ N°3	25	BL	2	51203IMP.02	3661589065780	3,14

CLASSIC

VIS.00515.IMP

EMBOUT DE VISSAGE SÉRIE 1/4" - TORX® IMPACT



				REF		€
T10	25	VR	15 mini	51505IMP	3661589065797	1,90
T10	25	BL	2	51505IMP.02	3661589065803	4,49
T15	25	VR	15 mini	51506IMP	3661589065810	1,90
T15	25	BL	2	51506IMP.02	3661589065827	4,49
T20	25	VR	15 mini	51507IMP	3661589065834	1,90
T20	25	BL	2	51507IMP.02	3661589065841	4,49
T25	25	VR	15 mini	51508IMP	3661589065858	1,90
T25	25	BL	2	51508IMP.02	3661589065865	4,49
T30	25	VR	15 mini	51510IMP	3661589065872	1,90
T30	25	BL	2	51510IMP.02	3661589065889	4,49
T40	25	VR	15 mini	51511IMP	3661589065896	1,90
T40	25	BL	2	51511IMP.02	3661589065902	4,49

ACCESSOIRES

CLASSIC

VIS.05110.TI

EMBOUT DE VISSAGE SÉRIE COURTE 1/4" - PHILLIPS® TITANE



				REF		€
PH N°1	25	VR	15 mini	51101TI	3510785421145	1,31
PH N°1	25	BL	2	51101TI.02	3510785102372	3,96
PH N°2	25	VR	15 mini	51102TI	3510785420957	1,31
PH N°2	25	BL	2	51102TI.02	3510785102396	3,96
PH N°3	25	VR	15 mini	51103TI	3510785421176	1,31
PH N°3	25	BL	2	51103TI.02	3510785102419	3,96

CLASSIC

VIS.05410.TI

EMBOUT DE VISSAGE SÉRIE LONGUE 1/4" - PHILLIPS® TITANE



				REF		€
PH N°1	50	VR	15 mini	54101TI	3510785421312	4,61
PH N°2	50	VR	15 mini	54102TI	3510785421091	4,61
PH N°3	50	VR	15 mini	54103TI	3510785421381	4,61

CLASSIC

VIS.05120.TI

EMBOUT DE VISSAGE SÉRIE COURTE 1/4" - POZIDRIV® TITANE



				REF		€
PZ N°1	25	VR	15 mini	51201TI	3510785421039	1,31
PZ N°1	25	BL	2	51201TI.02	3510785102433	3,96
PZ N°2	25	VR	15 mini	51202TI	3510785420810	1,31
PZ N°2	25	BL	2	51202TI.02	3510785102457	3,96
PZ N°3	25	VR	15 mini	51203TI	3510785420940	1,31
PZ N°3	25	BL	2	51203TI.02	3510785102471	3,96

CLASSIC

VIS.05420.TI

EMBOUT DE VISSAGE SÉRIE LONGUE 1/4" - POZIDRIV® TITANE



				REF		€
PZ N°1	50	VR	15 mini	54201TI	3510785421220	4,61
PZ N°2	50	VR	15 mini	54202TI	3510785421077	4,61
PZ N°3	50	VR	15 mini	54203TI	3510785421237	4,61

CLASSIC

VIS.00515.TI

EMBOUT DE VISSAGE SÉRIE 1/4"- TORX® TITANE



				REF		€
T10	25	VR	15 mini	51505TI	3510785421138	2,39
T15	25	VR	15 mini	51506TI	3510785421084	2,39
T20	25	VR	15 mini	51507TI	3510785420926	2,39
T25	25	VR	15 mini	51508TI	3510785420902	2,39
T30	25	VR	15 mini	51510TI	3510785421015	2,39

ACCESSOIRES

CLASSIC

VIS.58505

PORTE-EMBOUT MAGNÉTIQUE À SERRAGE RAPIDE 1/4"



				REF		€
60	VR	15 mini	58505	3510785420858	18,07	
60	BL	1	58505.01	3510785100811	21,97	

CLASSIC

VIS.05830

PORTE-EMBOUT MAGNÉTIQUE AVEC CIRCLIPS 1/4"



				REF		€
58	VR	15 mini	58300	3510785420773	5,79	
58	BL	1	58300.01	3510785100378	7,63	
74	VR	15 mini	58301	3510785420797	10,07	
74	BL	1	58301.01	3510785100804	12,23	

CLASSIC

VIS.58510

PORTE-EMBOUT MAGNÉTIQUE SPÉCIAL PLÂTRE 1/4"



				REF		€
60	VR	15 mini	58510	3510785420919	25,49	
60	BL	1	58510.01	3510785102730	28,09	

CLASSIC

VIS.58903

ADAPTATEUR CARRÉ 1/4"



				REF		€
50	VR		58903	3510784096801	16,34	

CLASSIC

VIS.58511

PORTE-EMBOUT MAGNÉTIQUE AVEC CIRCLIPS 1/4" SDS



				REF		€
78	VR		58511	3510784096788	19,05	

CLASSIC

VIS.58516

PORTE-EMBOUT À DOUBLE SYSTÈME MAGNÉTIQUE 1/4"



				REF		€
65	BL		58516.01	3661589065933	24,36	

ACCESSOIRES

CLASSIC

VIS.58514

PORTE-EMBOUT MAGNÉTIQUE À SERRAGE RAPIDE SPÉCIAL IMPACT 1/4"



		REF		€
60	BL	58514.01	3661589065919	25,98

CLASSIC

VIS.58515

PORTE-EMBOUT MAGNÉTIQUE SPÉCIAL IMPACT 1/4"



		REF		€
60	BL	58515.01	3661589065926	14,45

CLASSIC

VIS.51902

LOT DE 2 EMBOUTS AVEC BUTÉE POUR PLÂTRE.



PH N°2 x 2

	REF		€
	51902.02	3661589043405	4,55

CLASSIC

VIS.BIDOUILLE

COFFRET DE 7 DOUILLES 6 PANS 1/4" 50MM



1/4"/7/8/3/8"/10/12/13

	REF		€
	BIDOUILLE	3510789610002	46,59

CLASSIC

VIS.53005

COFFRET DE 5 DOUILLES IMPACT 6 PANS 1/4" 65MM



Zone de torsion maximale pour une longévité extrême.
5 douilles 1/4" 65 mm : 6/8/10/12/13.

	REF		€
	53005	3661589101945	42,76

ACCESSOIRES

CLASSIC



- 1/4" X 65mm : 8 - 10 - 13
- 25mm : PH1 - PH2X2 - PH3
50mm : PH1 - PH2X2 - PH3
89mm : PH2
- 25mm : T10 - T15 - T20X2 - T25X2 - T30 - T40
50mm : T10 - T15 - T20X2 - T25X2 - T30 - T40
89mm : T20 - T25
- 25mm : PZ1 - PZ2X2 - PZ3
50mm : PZ1 - PZ2X2 - PZ3
89mm : PZ2



VIS.53042

COFFRET DE DOUILLES 1/4" + EMBOUTS IMPACT 42 PIÈCES

Zone de torsion maximale pour une longévité extrême.

- 16 embouts 25 mm avec code couleur.
- 16 embouts 50 mm avec code couleur.
- 4 embouts 89 mm avec code couleur.
- 3 douilles 1/4" 65 mm.
- 1 porte embout magnétique 60 mm.
- 1 adaptateur douille 1/4".
- 1 adaptateur douille 3/8".

REF		€
53042	3661589101938	62,00

CLASSIC



- PH1 - PH2
- PZ1 - PZ2
- T10 - T15 - T20
T25 - T30 - T40

INOX



VIS.60011

COFFRET EMBOUTS DE VISSAGE INOX 11 PIÈCES

Embouts en acier inoxydable.
Haute résistance à la corrosion.
Aucun risque de rouille et évite la contamination des vis.
Durée de vie augmentée.
Idéal et recommandé pour la pose de vis inox.
10 embouts 25 mm.
1 porte embout magnétique 60 mm.

REF		€
60011	3661589101952	33,50

CLASSIC



- PH1 - PH2X2 - PH3
- PZ1 - PZ2X2 - PZ3
- 4 - 4,5 - 5 - 5,5
6 - 7 - 8 - 9 - 10
11 - 12 - 13 - 14
- 3 - 4 - 5 - 6 - 8
- T10 - T15 - T20 - T25 - T27 - T30 - T40
- TT10 - TT15 - TT20 - TT25 - TT27 - TT30 - TT40

INOX



VIS.60045

COFFRET DE DOUILLES 1/4" + EMBOUTS INOX 45 PIÈCES

Embouts et douilles en acier inoxydable.
Haute résistance à la corrosion.
Aucun risque de rouille et évite la contamination des vis.
Durée de vie augmentée.
Idéal et recommandé pour la pose de vis inox.
30 embouts 25 mm.
13 douilles 1/4".
1 porte embout magnétique 65 mm.
1 adaptateur douille 1/4".

REF		€
60045	3661589101969	112,00

ACCESSOIRES



VIS.57032



COFFRET EMBOUTS DE VISSAGE 32 PIÈCES

30 embouts 25 mm avec code couleur.
1 porte-embouts magnétique.
1 adaptateur douille 1/4".

REF		€
57032	3661589100535	29,76

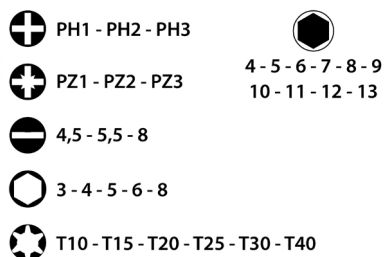

VIS.57036



COFFRET DE DOUILLES 1/4" + EMBOUTS 36 PIÈCES

20 embouts 25 mm.
10 douilles 1/4".
1 poignée tournevis.
1 cliquet réversible.
1 porte embout magnétique 60 mm.
1 adaptateur douille 1/4".
1 douille porte embout.
1 rallonge 100 mm.

REF		€
57036	3661589101921	87,50

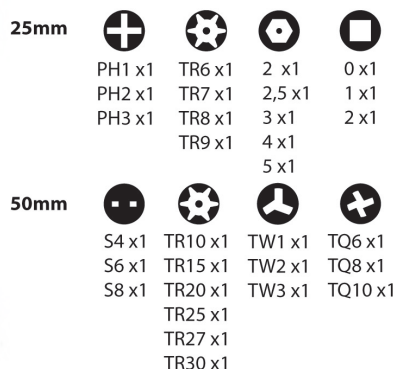

VIS.56030



COFFRET 30 EMBOUTS DE VISSAGE

Spécial maintenance électroménager.

REF		€
56030	3661589043382	28,36

ACCESSOIRES

CLASSIC



ø 8 - 10 - 12 - 13
ø 3 - 4 - 5 - 6

25mm	PH0 x 1	PZ0 x 1	4,5 x 1	1 x 1
	PH1 x 2	PZ1 x 1	5,5 x 1	2 x 1
	PH2 x 3	PZ2 x 3	6,5 x 1	3 x 1
	PH3 x 2	PZ3 x 2	8,0 x 1	
50mm	PH2 x 2	PZ2 x 2		
25mm	TT10 x 1	2,5 / 3 x 1	T10 / T15 x 1	
	TT15 x 1	4 / 5 x 1	T20 / T25 x 1	
	TT20 x 1	6 x 1	T27 / T30 x 1	
	TT25 x 1		T35 / T40 x 1	



VIS.56056

COFFRET EMBOUTS ET FORETS BOIS 1/4"
56 PIÈCES

40 embouts 25 mm.
4 embouts 50 mm.
2 porte-embouts.
1 adaptateur 1/4".
4 forets bois.
1 fraiseur.
4 douilles 1/4".

REF



€

56056

3510785983018

41,83

CLASSIC



ø 3 - 4 - 5 - 6 - 8

25mm	PH1 x 1	PZ1 x 1	T15 x 1	3 x 1
	PH2 x 1	PZ2 x 1	T20 x 1	4 x 1
	PH3 x 1	PZ3 x 1	T25 x 1	5 x 1
			T30 x 1	6 x 1
50mm	4,5 x 1	8,0 x 1		
	PH2 x 1	PZ2 x 1	T15 x 1	5,5 x 1
	PH3 x 1	PZ3 x 1	T20 x 1	
			T25 x 1	



VIS.56230

COFFRET EMBOUTS ET FORETS BOIS 1/4"
30 PIÈCES

Changement rapide du foret.
Pas de rotation dans le mandrin.
Forets en acier WS et porte-embout magnétique.

REF



€

56230

3661589092885

35,00

CLASSIC



ø 3 - 4 - 5 - 6 - 8

25mm	PH1 x 1	PZ1 x 1	T15 x 1	3 x 1
	PH2 x 1	PZ2 x 1	T20 x 1	4 x 1
	PH3 x 1	PZ3 x 1	T25 x 1	5 x 1
			T30 x 1	6 x 1
50mm	4,5 x 1	8,0 x 1		
	PH2 x 1	PZ2 x 1	T15 x 1	5,5 x 1
	PH3 x 1	PZ3 x 1	T20 x 1	
			T25 x 1	



VIS.56830

COFFRET EMBOUTS ET FORETS MÉTAL 1/4"
30 PIÈCES

Changement rapide du foret.
Pas de rotation dans le mandrin.
Forets en acier HSS et porte-embout magnétique.

REF



€

56830

3661589092878

38,00

ACCESSOIRES

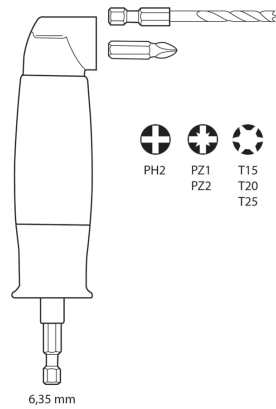

VIS.56007

RENOI D'ANGLE + EMOBOTS - 7 PIÈCES



Pour perceuses et visseuses.
Douille magnétique pour embouts et forets à queue 6 pans 1/4».
Rotation droite et gauche.
1 renvoi d'angle 90° + 6 embouts 25 mm.

REF		€
56007	3661589084835	26,63

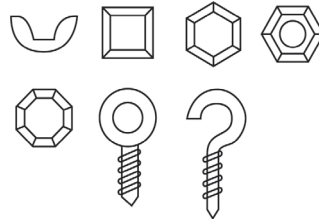

VIS.58003

KIT DOUILLE UNIVERSELLE + CLIQUET + ADAPTATEUR



Douille universelle composée de 54 broches en acier montées sur ressort.
S'adapte automatiquement à la forme de tous écrous, vis, crochets.
De 7 à 19 mm.
Livré avec un cliquet 3/8» et un adaptateur pour visseuse/dévisseuse.

REF		€
58003	3661589087980	29,58



- PH1 - PH2
- PZ1 - PZ2
- 4 - 5,5
- T15 - T20 - T25 - T30

VIS.55013

LOT 2 CLES POLYGAONALES 4 EN 1 A CLIQUET + 10 EMOBOTS



4 dimensions par clé.
Cliquet 72 dents, angle de reprise de 5°. Inverseur serrage / desserrage.
Forme droite.
Acier chrome Vanadium.
Pratique et compacte.
2 clés : 8*10, 12*13 / 16*17, 18*19.
10 embouts 25 mm.
1 adaptateur porte embout.

REF		€
55013	3661589089861	41,00

ACCESSOIRES

CLASSIC



VIS.55006

LOT DE 6 CLES POLYGONALES 2 EN 1 A CLIQUET



2 dimensions par clé.
Cliquet 72 dents, angle de reprise de 5°.
Inversion du sens de rotation par retournement de la clé.
Forme droite.
Acier chrome Vanadium.
6 clés : 8*9 / 10*11 / 12*13 / 14*15 / 16*17 / 18*19.

REF		€
55006	3661589089878	65,00

CLASSIC



VIS.55206

LOT 6 CLES POLYGONALES ARTICULEES 2 EN 1 A CLIQUET



2 dimensions par clé.
Cliquet 72 dents, angle de reprise de 5°.
Tête articulée sur 180°, idéal pour les accès difficiles.
Inversion du sens de rotation par retournement de la clé.
Acier chrome Vanadium.
6 clés : 8*9 / 10*11 / 12*13 / 14*15 / 16*17 / 18*19.

REF		€
55206	3661589089885	89,00

CLASSIC



- PH1 x 80 mm
- PH2 x 100 mm
- PZ1 x 80mm
- PZ2 x 100 mm
- 3 - 4 - 5,5 - 6,5 x 100 mm
- T10 - T15 - T20 x 100 mm

VIS.57012

COFFRET DE 12 TOURNEVIS ISOLÉS «ÉLECTRICIEN»



REF		€
57012	3661589080059	59,52



EN IEC 60900





info@leman-sa.com

 **BOIS MASSIF**

P. 434

EXPERT  pour les travaux spécialisés et de haute technicité.

CLASSIC  pour les travaux courants et polyvalents.



BOIS MASSIF

CLASSIC



TSB.870.CMAN.08

COFFRET DE MANDRIN DE TOURNAGE FILETAGE M33 X 3,5 MM

- 1 mandrin : 1,8 kg, Ø du corps 96 mm, serrage de 67 à 32 mm, extension de 45 à 82 mm, par clé BTR
- 1 anneau lapidaire ø ext. 75 mm, ø int. 46 mm
- 2 queues de cochon
- 1 bague d'adaptation M33 x 3,5 / 1"x8 TPI + clés



REF		€
870.COFFRETMAN.08	3510785433995	314,91

CLASSIC



TSB.870.MAN

MANDRIN UNIVERSEL À 4 MORS POUR TOUR À BOIS

- Mandrin à serrage concentrique filetage M33 x 3,5.
- Livré avec mors 50 mm : travail de 33 à 65 mm en intérieur et 47 à 80 mm en extérieur.
- Queue de cochon.
- Réglages d'ouverture et de fermeture à l'aide de tiges, par rotation de la bague arrière (course de 27 mm).



REF		€
870.MAN.01	3510785416653	201,12

CLASSIC



TSB.870.CMAN.09

COFFRET DE MANDRIN DE TOURNAGE FILETAGE 1"X 8TPI

- 1 mandrin : 1 kg, Ø du corps 70 mm, serrage de 47 à 29 mm, extension de 34 à 52 mm, par clé BTR.
- 1 grand mors (type A) ø ext. 69,5 mm, ø int. 57,5 mm
- 1 mors (type B) ø 22 mm
- 1 mors (type D) ø ext. 36 mm, ø int. 17 mm
- 1 anneau lapidaire ø ext. 65 mm, ø int. 40 mm
- 1 queue de cochon
- 1 bague d'adaptation 1»x8 TPI / M33 x 3,5 + clés



REF		€
870.COFFRETMAN.09	3510785434008	364,22

BOIS MASSIF

CLASSIC



TSB.870.CMAN.02 COFFRET MANDRIN + MÈCHE Ø 35

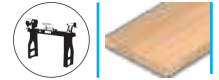

1 mèche à façonner \varnothing 35 LT 100 mm.
1 mandrin extensible, à serrage rapide M33 x 3,5 mm.
Corps \varnothing 45 mm / Extension de 34 à 42 mm.

REF		€
870.COFFRETMAN.02	3510785434015	55,67

CLASSIC



TSB.870.MORS COFFRET DE 4 MÂCHOIRES POUR MANDRIN



- Tous les mors sont utilisables en compression et en expansion.
- Goupille de sécurité interdisant une ouverture excessive.
- A = Grand mors
- B = Mors long
- C = Mors moyen
- D = Mini mors

REF		€
870.MORS.04	3510785434022	206,17

CLASSIC



TSB.870.PLA PLATEAU DE REPRISE \varnothing 190 (4 MORS + ACCESSOIRES)



- Reprise des pièces finies.
- 16 taquets PVC pour préserver la pièce: 8 x 17 mm et 8 x 12 mm.
- Capacité en compression : 46 - 190 mm.
- Capacité en expansion : 66 - 220 mm.
- Compatible avec mandrin M33 du 870.COFFRETMAN.08

REF		€
870.PLATEAU.01	3510785434039	60,74



BOIS MASSIF

CLASSIC



TSB.870.GOB

GOBELET DE TOURNAGE FILETAGE M33 X 3,5 MM



- Usiné en acier.
- Maintien lors de tournage en l'air.
- Système de fixation sûr, simple et économique.
- Montage sur tours en filetage M33 x 3,5 mm.

Mise à la cote légèrement conique du talon de la pièce de bois, puis emmanchage de force dans le gobelet.

REF		€
870.GOB.308	3661589085542	35,24
870.GOB.408	3661589085559	35,24
870.GOB.608	3661589085566	43,61

CLASSIC



TSB.870.ACC

ACCESSOIRES POUR MANDRIN DE TOURNAGE



		REF		€
1	M33 X 3,5 mâle / 1" X 8TPI femelle	870.BAGUE1	3661589047984	19,86
2	1" X 8TPI mâle / M33 X 3,5 femelle	870.BAGUE2	3661589047991	15,97
3	Queue de cochon	870.016.00	3661589085511	15,68
4	Pignon M33 X 3,5 mm	870.005.08	3661589082091	13,14
5	Pignon 1" X 8TPI	870.005.09	3661589082121	13,56
6	Couronne crantée M33 X 3,5 mm	870.008.08	3661589082107	40,45
7	Couronne crantée 1" X 8TPI	870.008.09	3661589082138	36,04
8	Circlips extérieur M33 X 3,5 mm	870.009.08	3661589082114	0,89
9	Circlips extérieur 1" X 8TPI	870.009.09	3661589082145	0,77

BOIS MASSIF



TSB.G00871
GOUGE À DÉGROSSIR



- Facile à manipuler, pour dégrossir les pièces de bois.
- 1er outil de cylindrage de pièce.

LM	U		LU		REF		€
220	10	380	160	19	871.519.00	3510788715197	72,86



TSB.G00872
GOUGE À PROFILER



- Outil polyvalent et précis pour la mise en forme et la finition des surfaces courbes, gorges et tores.

LM	U		LU		REF		€
220	8	380	160	10	872.510.00	3510788725103	43,56



TSB.G00873
GOUGE À CREUSER



- Creusage en bois de fil.
- Usinage des coupes, assiettes, bols, etc...
- Utilisation possible comme gouge à profiler.

LM	U		LU		REF		€
350	9	510	160	10	873.510.00	3510788735102	70,35

BOIS MASSIF



EXPERT



TSB.G00861

BÉDANE



- Usinage des épaulements, saignées droites ou tronçonnage de surfaces arrondies.
- Outil de calibrage par excellence.

LM		LU		REF		€
220	380	160	10	861.510.00	3510788615107	58,27



EXPERT



TSB.G00881

ANNEAU DOUBLE



- Creusage en bois de bout.
- Creusage profond avec un état de surface impeccable.
- Anneau à double cône : extérieur pour le creusage, intérieur pour le dressage de fond.

Ø	LM		LU	REF		€
13/17	220	400	180	881.513.00	3510788815132	62,26

BOIS MASSIF



TSB.G00862
PLANE OVALE



- Outil de tranche, pour cylindrer des formes droites, profilées et convexes.
- Grande liberté d'angle.

LM		LU			REF		€
220	380	160	25	7	862.525.00	3510788625250	71,54



TSB.G00864
CISEAU RACLOIR ARRONDI



- Pour creuser facilement en travail frontal des bois en bout.
- Rendement faible idéal pour les débutants.

LM		LU			REF		€
220	380	160	19	6	864.519.00	3510788645197	48,63



BOIS MASSIF

CLASSIC

TSB.G870.05 COFFRET DE 5 OUTILS DE TOURNAGE



- Gouge à dégrossir, à profiler, bédane, grain d'orge, à creuser.

HSS

REF		€
870.500.05	3510788705006	162,95

CLASSIC

TSB.G870.03 COFFRET DE 3 OUTILS DE TOURNAGE



- Gouge plane plate, grain d'orge et à profiler.
- Basiques en manche court de 195 mm pour une longueur totale de 280 mm.

HSS

REF		€
870.500.03	3661589092847	72,00

CLASSIC

TSB.G870.04 OUTIL DE TOURNAGE 4 EN 1



- 4 têtes interchangeables : droite, bombée, gorge, grain d'orge.
- Manche 300 mm pour une longueur totale de 470 mm maximum.

HM

REF		€
870.700.04	3661589092854	72,00





BOIS MASSIF



TSB.C00780

CISEAU À BOIS À MANCHE BI-MATIÈRE

- Hautes performances.
- Manche revêtu d'uréthane souple et renfort métallique à l'extrémité.

				REF		€
125	265	140	6	780.506.00	3510785401192	10,88
125	265	140	10	780.510.00	3510785401246	10,99
125	265	140	12	780.512.00	3510785401260	11,48
125	265	140	14	780.514.00	3510785401277	11,80
125	265	140	16	780.516.00	3510785401284	12,07
125	265	140	20	780.520.00	3510785401307	13,32
125	265	140	24	780.524.00	3510785401321	13,85
125	265	140	26	780.526.00	3510785401338	13,85
125	265	140	30	780.530.00	3510785401352	14,50
125	265	140	40	780.540.00	3510785402458	19,33

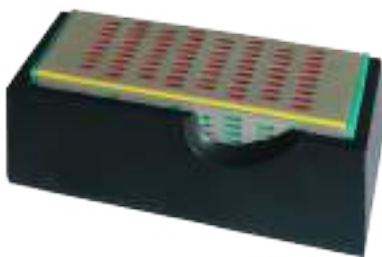

TSB.785.04

BLOC D'AFFÛTAGE DIAMANTÉ 4 FACES

- Pour ciseaux à bois, fers profilés, fers de rabot et outils acier ou carbure.
- Dimensions : 150 x 50 x 50 mm.
- Grains : 200 + 300 + 400 + 600

REF		€
785.000.04	3661589088840	25,11



BOIS MASSIF

CLASSIC



TSB.C780.06

COFFRET DE 6 CISEAUX À BOIS À MANCHE BI-MATIÈRE



- Hautes performances.
- Manche revêtu d'uréthane souple et renfort métallique à l'extrémité.
- Largeurs 6, 10, 16, 20, 24, 30 mm.

REF



€

780.500.06

3510787805066

78,30

CLASSIC



TSB.C780.03

COFFRET DE 3 CISEAUX À BOIS À MANCHE BI-MATIÈRE + PIERRE



- Hautes performances.
- Manche revêtu d'uréthane souple et renfort métallique à l'extrémité.
- Largeurs 12, 26, 40 mm.
- Pierre d'affûtage.

REF



€

780.500.03

3510787805035

39,77

CLASSIC



TSB.780.00

PIERRE À AFFÛTER DOUBLE FACE

- Pour ciseaux à bois et outils en acier HSS.
- Dimensions : 200 x 50 x 25 mm.
- Grains : 120 + 140

REF



€

780.000.00

3510785413003

5,68





info@leman-sa.com

SERRAGE ET SERVANTES

SERRAGE

P. 446

ÉTAIS & SERVANTES

P. 452

EXPERT  pour les travaux spécialisés et de haute technicité.

CLASSIC  pour les travaux courants et polyvalents.



ACCESSOIRES

EXPERT

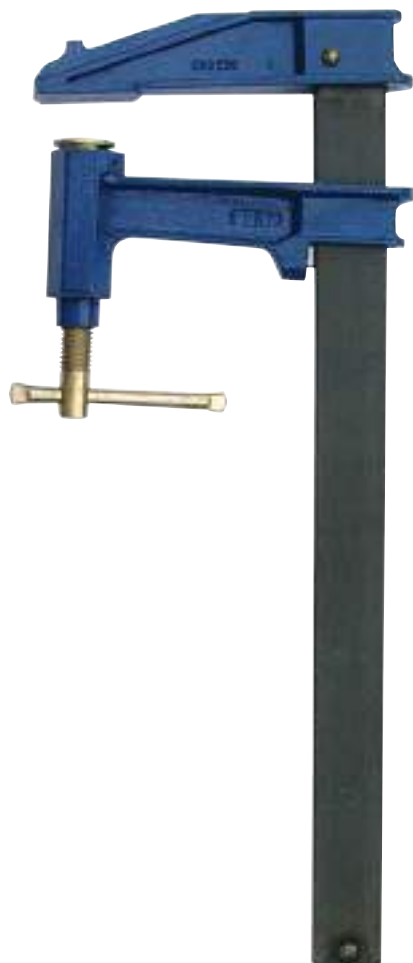

SER.00090

SERRE-JOINT À POMPE



- Idéal pour le serrage puissant des matériaux pour les chantiers de menuiserie et de maçonnerie.
- Serre-joint à pompe avec tête en fonte trempée et dentée.
- Frein antiglissant en acier trempé et denté.
- Tige en acier laminé et calibrée.
- Piston de serrage en une seule pièce en acier.
- Double vis filet métrique, avec manche en croix.



					REF		€
90	28 x 8	200	4	090.288.020	3510780900201	21,29	
90	28 x 8	300	4	090.288.030	3510780900300	24,36	
90	28 x 8	400	4	090.288.040	3510780900409	27,09	
90	28 x 8	600	4	090.288.060	3510780900607	32,82	
120	35 x 8	300	4	120.358.030	3510781200300	27,09	
120	35 x 8	400	4	120.358.040	3510781200409	29,82	
120	35 x 8	500	4	120.358.050	3510781200508	32,50	
120	35 x 8	600	4	120.358.060	3510781200607	34,83	
120	35 x 8	800	4	120.358.080	3510781200805	39,85	
120	35 x 8	1000	4	120.358.100	3510781201000	46,37	
120	35 x 8	1200	4	120.358.120	3510781201208	49,99	
120	35 x 8	1500	4	120.358.150	3510781201505	57,63	
150	40 x 10	400	4	150.410.040	3510781500400	45,76	
150	40 x 10	500	4	150.410.050	3510781500509	48,21	
150	40 x 10	600	4	150.410.060	3510781500608	51,00	
150	40 x 10	800	4	150.410.080	3510781500806	56,23	
150	40 x 10	1000	4	150.410.100	3510781501001	60,91	
150	40 x 10	1200	4	150.410.120	3510781501209	65,16	
150	40 x 10	1500	4	150.410.150	3510781501506	71,68	
150	40 x 10	2000	4	150.410.200	3510781502008	82,66	
150	40 x 10	2500	4	150.410.250	3510781502503	93,19	
150	40 x 10	3000	4	150.410.300	3510781503005	103,34	

ACCESSOIRES

EXPERT 

SER.LOT120 LOT DE 6 SERRE-JOINTS À POMPE



				
			600	x2
120	35 x 8		800	x2
			1000	x2

	REF		€
1	LOT.120.358	3510781203585	220,41

EXPERT 



SER.00150 PROTECTION NYLON

	REF		€
10	150.000.000	3510785424528	2,01





EXPERT 



SER.00300 SERRE-JOINT À POMPE - SAILLIE LARGE



- Saillie large permettant les serrages profonds.
- Serre-joint à pompe avec tête en fonte renforcée.
- Frein antiglissant en acier trempé et denté.
- Tige en acier laminé et calibrée. Piston de serrage en une seule pièce en acier.
- Double vis filet métrique, avec manche en croix.

				REF		€
300	40 x 10	300	2	300.410.030	3510783004302	86,82
300	40 x 10	400	2	300.410.040	3510783004401	94,10
300	40 x 10	500	2	300.410.050	3510783004500	95,47
300	40 x 10	600	2	300.410.060	3510783004609	96,95
300	40 x 10	800	2	300.410.080	3510783004807	106,71
300	40 x 10	1000	2	300.410.100	3510783004104	107,83

ACCESSOIRES

EXPERT

SER.00080 SERRE-JOINT DORMANT



- Idéal pour le serrage de forte puissance dans les assemblages des panneaux bois, fenêtres, portes et meubles.
- Piston de pression en une seule pièce, filetage grande puissance avec manche en croix, barre en acier IPN percée pour la fixation du sabot mobile, face d'appui en fonte.
- Serre-joint de forte puissance pour le serrage de fenêtres, portes, meubles...
- En acier, section 80x42 / Surface de serrage 80x105.

				REF		€
80 x 42	1500	1	080.42.1500	3510780801508	197,29	
80 x 42	2000	1	080.42.2000	3510780802000	217,12	
80 x 42	2500	1	080.42.2500	3510780802505	247,18	
80 x 42	3000	1	080.42.3000	3510780803007	279,50	

EXPERT

SER.07040 SERRE-JOINT À PANNEAUX



- Serre-joint puissant pour le serrage de panneaux, portes de cuisine, châssis...
- Tige en acier laminé, section 40x10.
- Surface de serrage 60x35.

				REF		€
40 x 10	1000	1	7040.10.1000	3510784010005	72,02	
40 x 10	1500	1	7040.10.1500	3510784015000	80,41	
40 x 10	2000	1	7040.10.2000	3510784020004	86,42	
40 x 10	2500	1	7040.10.2500	3510784025009	91,00	

CLASSIC

SER.00041 LOT DE 2 TÊTES DE DORMANT

- Support dormant épaisseur 27 mm.



		REF		€
1	041.00.002	3510780410021	42,14	

ACCESSOIRES

CLASSIC



SER.07050

SERRE-JOINT À MANCHE



- Manche anti-dérapant ergonomique.
- Idéal pour le serrage rapide et précis de pièces moyennes.
- Précis pour les petits serrages.
- Tige en acier, saillie en fonte et manche en plastique.

				REF		€
50	15 x 5	150	10	7050.155.015	3661589065599	9,64
50	15 x 5	200	10	7050.155.020	3661589065605	10,18
50	15 x 5	250	10	7050.155.025	3661589065612	10,61
80	22 x 6	150	10	7070.187.015	3510781870152	11,32
80	22 x 6	200	10	7070.187.020	3510781870206	12,05
80	22 x 6	250	10	7070.187.025	3510781870251	12,82
80	22 x 6	300	10	7070.187.030	3510781870305	13,38
120	30 x 8	800	4	7120.308.080	3661589065643	30,86
120	30 x 8	1000	4	7120.308.100	3661589065650	32,04
120	30 x 8	400	4	7120.308.040	3661589065629	24,46
120	30 x 8	600	4	7120.308.060	3661589065636	28,04

CLASSIC



SER.07120

SERRE-JOINT À POMPE À TIGE CHROMÉE ET CRANTÉE



- Serre-joint à pompe avec tête en fonte.
- Frein antiglissant en acier trempé et denté.
- Tige en acier chromé et crantée.

				REF		€
120	35 x 8	300	4	7120.358.030	3510783580301	26,42
120	35 x 8	400	4	7120.358.040	3510783580400	28,82
120	35 x 8	500	4	7120.358.050	3510783580509	29,94
120	35 x 8	600	4	7120.358.060	3510783580608	30,16
120	35 x 8	800	4	7120.358.080	3510783580806	31,94
120	35 x 8	1000	4	7120.358.100	3510783581001	34,66
120	35 x 8	1200	4	7120.358.120	3510783581209	42,97
120	35 x 8	1500	4	7120.358.150	3510783581506	45,87

CLASSIC



SER.00091

PRESSE PARALLÈLE À MANCHE



- Pression parallèle et perpendiculaire sur de larges mâchoires idéale pour caisson et cadrage.
- Tige crantée section 30 x 8 mm en acier C45.
- Poignée ergonomique anti-dérapante.
- Protecteurs en plastique doux pour respecter la surface des pièces à serrer.
- Petite butée positionnable pour une utilisation en dormant.

					REF		€
90	30 x 8	400	1	091.308.040	3661589086754	45,71	
90	30 x 8	600	1	091.308.060	3661589086761	56,21	
90	30 x 8	800	1	091.308.080	3661589086778	64,09	
90	30 x 8	1000	1	091.308.100	3661589086785	71,13	
90	30 x 8	1500	1	091.308.150	3661589086792	89,73	

ACCESSOIRES

CLASSIC

SER.07110 PRESSE SERRAGE RAPIDE UNE MAIN



- Idéal pour le serrage rapide d'une seule main
- Tige en acier, corps en plastique moulé.
- Serrage interne ou externe.

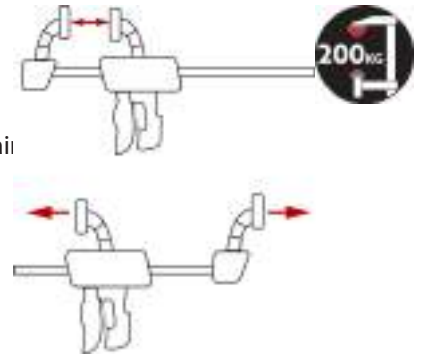

				REF		€
85	20 x 5	150	6	7110.185.015	3510780113243	24,25
85	20 x 5	300	6	7110.185.030	3510780113267	28,43
85	20 x 5	450	6	7110.185.045	3510780113274	29,82
85	20 x 5	600	6	7110.185.060	3510780113281	32,72

CLASSIC



SER.07301 PRESSE RAPIDE LÉGÈRE

- Mâchoire et crémaillère de serrage en plastique robuste.
- Tige section 20x5 mm en acier zingué, crantée.



				REF		€
90	20 x 5	150	1	7301.205.015	3661589086808	11,45
90	20 x 5	300	1	7301.205.030	3661589086815	12,92

CLASSIC

SER.07300 PRESSE SERRAGE PUISSANT



- Poignée ergonomique pour serrage à une main.
- Idéal pour les pièces moyennes.
- Ouverture progressive.
- Serrage interne ou externe.



				REF		€
80	20 x 5	300	10	7300.205.030	3661589022554	45,47

ACCESSOIRES

CLASSIC



SER.07086 ÉTAI EXTENSIBLE

- Multi-usages
- Facilite le maintien des pièces, objets, matériaux, ...
- Patins en caoutchouc antidérapant aux deux extrémités.
- Blocage de sécurité.

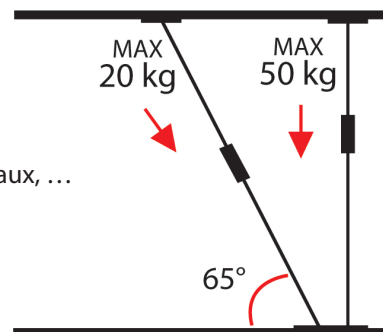

		REF		€
75 - 125	1	7086.075.125	3661589006271	36,90
100 - 175	1	7086.100.175	3661589025784	40,85
145 - 250	1	7086.145.250	3661589022585	41,67
160 - 290	1	7086.160.290	3661589006288	44,70

CLASSIC



SER.00400 SERVANTE D'ATELIER À ROULEAU

- Rouleau galvanisé, monté sur roulements.
- Hauteur réglable, blocage par vis.
- Charge maximum : 80 Kg.
- Hauteur maximum : 100 cm.
- Livrée à monter.

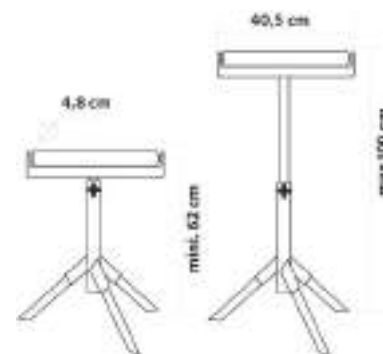

	REF		€
1	400.950.150	3510784009504	68,16
10	400.950.150.10	3510785434268	510,99

CLASSIC



SER.00406 SERVANTE ROULEAU + PLATEAU À BILLES PIED DOUBLE

- Rouleau galvanisé, monté sur roulements.
- Mixte : rouleau et plateau à billes escamotable.
- Hauteur réglable par crans et blocage par vis.
- Charge maximum : 100 Kg.
- Hauteur maximum : 109 cm.

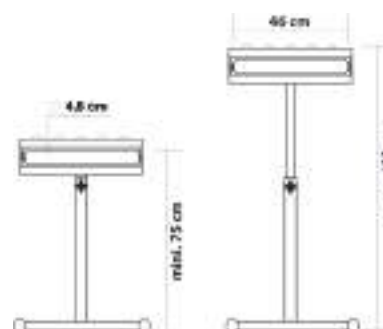

	REF		€
1	406.950.150	3661589088802	95,50





info@leman-sa.com

ACCESSOIRES

EXPERT  pour les travaux spécialisés et de haute technicité.

CLASSIC  pour les travaux courants et polyvalents.

 **WorkHardWorkFine**



ACCESSOIRES

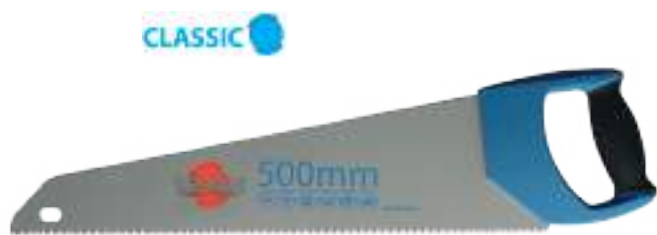

ACC.SE.03 SCIE ÉGOÏNE DE COFFREUR

- Grosse denture droite pour sciage rapide.
- Denture double affûtage diamant.
- Pas 3,7 TPI.



	REF		€
500	670.500.03	3510785401505	27,01

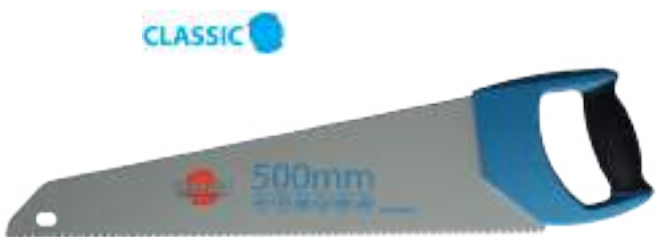

ACC.SE.07 SCIE ÉGOÏNE BARRACUDA

- Sciage propre et rapide de plâtre et matériaux tendres.
- Coupe transversale des fibres de bois.
- Denture fine trempée.
- Pas 7 TPI.



	REF		€
500	670.500.07	3510785401499	27,98



ACC.SE.34 SCIE ÉGOÏNE MATÉRIAUX POREUX

- Denture carbure 34 dents sur lame rigide de 3 mm.
- Poignée ergonomique massive.
- Coupe de béton poreux et panneaux isolants.



	REF		€
630	670.630.34	3661589084682	60,00



ACC.00510 LAMES SCIE A MAIN BI-MÉTAL

- Lames denture ondulée incassable.
- Sciage de tous les aciers.
- Acier rapide supérieur à 8% de cobalt
- PAS annoncé en denture TPI = dents par pouce.



			REF			€	
10	0,65	13	300	51099	100	3510780510998	260,42
10	0,65	13	300	51010	10	3510780104302	29,06
12	0,65	13	300	51120	100	3510780104319	260,42
12	0,65	13	300	51012	10	3510780104326	29,06

ACCESSOIRES



ACC.TLM040 TÉLÉMÈTRE LASER - 40M



- Ergonomique et simple d'utilisation pour toutes les opérations élémentaires (distance, surface, volume, Pythagore, addition et soustraction) et niveau à bulle.
- Rétro-éclairage et indicateur du niveau de batterie.
- Choix du repère de mesure : à l'avant ou à l'arrière de l'appareil.
- Mesures de 0,2 à 40 mm (1 mm minimum) +/- 2 mm. Laser catégorie 635nm Classe II.
- Livré avec 1 pochette de rangement avec passant, 1 dragonne, 2 piles AAA, notice d'utilisation.

			REF			ECOTAXE	€
26,5	54	118	TLM040	1	3661589080523	0,12	87,72



ACC.384.IAD INDICATEUR ANGULAIRE À AFFICHAGE DIGITAL



- Rétroéclairage automatique LCD.
- Mesures absolues et relatives.
- Angle en degrés, résolution 0,1°.
- Base magnétique.
- Inversion des chiffres selon vue utilisateur.

			REF			ECOTAXE	€
28	58	58	384.IAD.180	1	3661589084699	0,12	41,78



ACC.384.JPD JAUGE DE PROFONDEUR À AFFICHAGE DIGITAL



- Mesure horizontale et verticale.
- Précision de 0,1 mm.
- Règle de mesure avec vis de verrouillage, pignons amovibles.
- Plage de mesure: entraxe pieds 85 mm x profondeur 80 mm (50 mm avec utilisation de la pignons).
- Unité métrique et impériale.

			REF			ECOTAXE	€
25	140	110	384.JPD.080	1	3661589084736	0,12	41,78

ACCESSOIRES

CLASSIC



ACC.380.REGL
RÉGLET DE TOUPILLEUR



- Réglage en hauteur et en profondeur des outils de toupie.
- Réglet en alliage léger.
- Graduation paire et impaire recto/verso.



			REF			€
2	65	500	380.700.500	1	3510783807002	27,27

CLASSIC



ACC.RAIL
RAIL DE GUIDAGE



- Serrage excentrique pour s'adapter à tous les supports.
- Butée arrière coulissante.
- Rail aluminium.

		REF			€
53	600	RAIL.053.060	1	3661589086822	38,77
86	1250	RAIL.086.125	1	3661589086839	65,57

CLASSIC



ACC.406.LP
LÈVE-PORTE



- Lève-porte ou lève-plaque à pédale articulée pour une montée verticale.
- Patin rotatif anti-dérapant.
- Charge 100 kg max.
- Hauteur levée 60 mm max.

REF			€
406.033.100	1	3661589088819	44,02

ACCESSOIRES

EXPERT



ACC.56009 JEU DE 4 PALES MIXTES



- Lissage des sols en béton frais.
- Pour hélicoptère de sol \varnothing 900.

			REF			€
ÉCROU FLOTTANT	200	335	5600900	1	3661589016355	119,03
3 ÉCROUS FIXES - ENTRE-AXE 121 MM	205	355	5600901	1	3661589025029	119,03

CLASSIC



ACC.ABR MALAXEUR

M14

- Pour produits pâteux lourds, enduits, mortiers, bétons

			REF			€
120	575		ABR121	1	3661589026651	23,22
120	590		ABR122	1	3661589026668	25,54
140	590		ABR142	1	3661589046802	24,41
160	590		ABR161	1	3661589026699	28,95

CLASSIC



ACC.900 MÉLANGEUR DE COLLE



- Pour produits pâteux: peintures, plâtres, colles.

				REF			€
6 PANS	100	600	150	900.002	1	3661589012562	15,16
SDS+	100	400	150	900.006	1	3661589061546	18,40

ACCESSOIRES

CLASSIC



ACC.913.002

MANDRIN AUTO-SERRANT + ADAPTATEUR SDS+/SPIT



REF			€
913.002	1	3661589051028	51,95

CLASSIC



ACC.913.003

KIT MANDRIN + CLÉ + ADAPTATEUR SDS+/SPIT



REF			€
913.003	1	3661589043412	19,48

CLASSIC



ACC.CM13

CLÉ DE MANDRIN DE 1,5 À 13 MM

REF			€
CM13	1	3510780001137	3,91

CLASSIC



ACC.ADPSDS

ADAPTATEUR SDS+/SPIT POUR MANDRIN



REF			€
ADPSDS	1	3510780111133	8,04



ACCESSOIRES

CLASSIC



ACC.900.ECR
ÉCROU DE MEULEUSE



M14

REF			€
900.005	1	3661589012593	4,28

CLASSIC





ACC.900.CM
CLÉ DE MEULEUSE UNIVERSELLE

REF			€
900.004	1	3661589012586	8,07

CLASSIC



ACC.CM230
CLÉ DE MEULEUSE À DOUBLE ERGOT POUR DISQUES Ø230

REF			€
CM230	1	3510781111132	6,34

ACCESSOIRES



CLASSIC



ACC.LUBRI

SPRAY LUBRIFIANT QUALITÉ PROFESSIONNELLE 500 ML

- Améliore le glissement du bois.
- Sans silicone, ne laisse pas de trace et permet tout type de finition.
- 650 ml brut / 500 ml net.
- Produit dangereux, respecter les précautions d'emploi.

REF			€
LUBRISPRAY	12	3510785419029	14,11



CLASSIC



ACC.NET125

NETTOYANT POUR OUTILS DE COUPE 125 ML

- Lames, mèches défonceuses, fers, plaquettes...
- À diluer dans 5 fois son volume d'eau.
- Tremper l'outil et laisser agir quelques minutes. Brosser ensuite avec un pinceau en fibres synthétiques.
- Ne pas utiliser sur les outils en alliage léger (aluminium). Dans ce cas, démonter les tranchants pour en effectuer le nettoyage.
- Produit dangereux, respecter les précautions d'emploi.

REF			€
NET125	18	3661589041081	10,92

CLASSIC







ACC.EQM

ÉQUERRE MAGNÉTIQUE



- Positionnement de pièces avant soudage à 45°, 90° et 135°.

			REF			€
15	90	90	EQM090	1	3661589087997	8,52
25	110	110	EQM110	1	3661589088000	13,56

ACCESSOIRES

CLASSIC



ACC.00571

UNIVERSELLE | ÉLECTRODES RUTILE «E 6013»

- Universelles.



Ø	Icon	REF	Icon	Icon	€
2	300	571.20.04	4 kg	3661589030122	50,21
2,5	350	571.25.05	5 kg	3661589030139	47,94
3,2	350	571.32.05	5 kg	3661589030146	46,21
4	350	571.40.05	5 kg	3661589030153	47,30

CLASSIC



ACC.00572

UNIVERSELLE | ÉLECTRODES BASIQUES «E 7018»

- Excellentes résiliences jusqu'à 50°C.
- Bonne résistance à la fissuration à froid, laitier facile à enlever.



Ø	Icon	REF	Icon	Icon	€
2,5	350	572.25.05	5 kg	3661589030177	56,88
3,2	450	572.32.05	5 kg	3661589030184	45,50

CLASSIC



ACC.00573

ÉLECTRODES INOX «E 316-L»

- Soudage des inox et des aciers appliqués.
- Excellente résistance à la corrosion dans l'eau de mer.



Ø	Icon	REF	Icon	Icon	€
2	300	573.20.01	1 kg	3661589030207	59,47
2,5	300	573.25.01	1 kg	3661589030214	58,66
3,2	350	573.32.01	1 kg	3661589030221	56,55



info@leman-sa.com

MACHINES

MACHINES BOIS P. 466

MACHINES BÂTIMENT P. 508

MACHINES MÉTAL P. 530

MACHINES OUTDOOR P. 538





info@leman-sa.com

MACHINES BOIS

SCIES À RUBAN	P. 468
SCIES SUR TABLE	P. 472
DÉGAUCHISSEUSES - RABOTEUSES	P. 475
MORTAISEUSES À BÉDANE	P. 481
TOUPIE - ENTRAINEUR	P. 483
DÉFONCEUSE STATIONNAIRE	P. 485
COMBINÉS	P. 486
ASPIRATEURS À COPEAUX	P. 490
TOURS À BOIS	P. 495
AFFÛTEUSE - PONCEUSES	P. 500
SCIES À ONGLETS - SCIE À CHANTOURNER	P. 504





SRU470 (MONOPHASE) - SRU470T (TRIPHASE)
SCIE À RUBAN • 470 MM

- Bâti mécano-soudé rigide et robuste.
- Double berceau de table à crémaillère.
- Guide de lame supérieur monté sur crémaillère et réglable en hauteur par une manivelle.
- Réglage de tension de la lame par une manivelle avec graduation lisible de l'extérieur.
- Levier de détente rapide de la lame.
- Brosse de nettoyage sur le volant inférieur, permettant à la lame d'avoir une bonne adhérence.
- 2 vitesses de coupe par changement de position de la courroie suivant les pièces à découper (bois/acier).
- Guide de coupe longitudinale avec loupe de lecture pour la graduation et poignée de serrage rapide, graduation de chaque côté de la lame.
- Guide d'onglet réglable de - 60° à + 60°, positionnable à droite et à gauche de la lame.
- Contacteur de sécurité sur chaque porte.

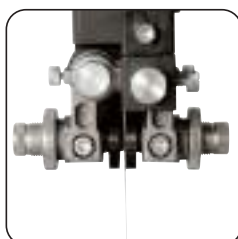

Volants en fonte d'acier équilibrés



Guide de lame supérieur et inférieur à galets



Table inclinable à 45°

GARANTIE	2
Puissance moteur (230/400V - 50Hz)	1900W-S1/2000W-S1
Encombrement (LxlxH)	900 x 680 x 1860 mm
Largeur de coupe	465 mm
Hauteur de coupe	265 mm
Longueur de la lame	3454 mm
Largeur de la lame	6 à 40 mm
Dimensions de la table (LxP)	725 x 485 mm
Inclinaison de la table	-10° à +45°
Hauteur de travail	950 mm
Diamètre des volants	475 mm
Vitesses de la lame	380 ou 820 m/min
Sortie d'aspiration	ø 100 mm (x 2)
Poids Net	156 Kg
Référence pour pièces détachées	
- Mono	110300(+ N°/vue éclatée)
- Tri	110400(+ N°/vue éclatée)
Gencod	
- Mono	3700501700177
- Tri	3700501700184
Colisage (LxlxH)	2000 x 830 x 530 mm
Poids Brut	175 Kg
Prix	1933,05€
Ecotaxe	2,08€

FOURNITURES ET ACCESSOIRES

- La machine est livrée avec le guide de refente, la rallonge de table, le guide d'onglet, 1 lame largeur 16 mm, clés et notice d'utilisation.



LEMAN	€
Kit de déplacement 110310	91,54

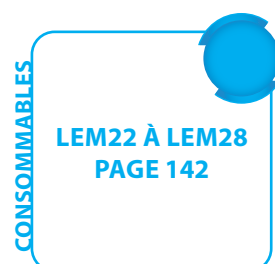



SRU356 (MONOPHASE) SCIE À RUBAN • 355 MM



- Bâti mécano-soudé rigide et robuste.
- Large berceau de table en fonte d'aluminium.
- Guide de lame supérieur et inférieur à galets.
- Guide de la lame supérieur monté sur crémaillère et réglable en hauteur par une manivelle.
- Levier de détente rapide de la lame.
- Brosse de nettoyage sur le volant inférieur, permettant à la lame d'avoir une bonne adhérence.
- 2 vitesses de coupe par changement de position de la courroie suivant la matière à découper, bois/acier.
- Guide de coupe longitudinale avec graduation du côté gauche de la lame.
- Guide d'onglet réglable de -60° à $+60^\circ$, positionnable à droite et à gauche de la lame.
- Contacteur de sécurité sur chaque porte.



Volants en fonte d'acier équilibrés

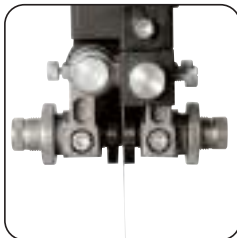

Guide de lame supérieur et inférieur à galets



Table inclinable à 45°

GARANTIE	2
Puissance moteur (230 V - 50Hz)	1450W-S1
Encombrement (LxlxH)	850 x 770 x 1800 mm
Largeur de coupe	345 mm
Hauteur de coupe	235 mm
Longueur de la lame	2630 mm
Largeur de la lame	6 à 20 mm
Dimensions de la table (LxP)	548 x 400 mm
Inclinaison de la table	0 à 45°
Hauteur de travail (sur piétement)	1040 mm
Diamètre des volants	350 mm
Vitesses de la lame	440 ou 900 m/min
Sortie d'aspiration	\varnothing 100 mm
Poids Net	100 Kg
Référence pour pièces détachées	110600 (+ N°/vue éclatée)
Gencod	3700501703383
Colisage (LxlxH)	1300 x 460 x 590 mm
Poids Brut	110 Kg
Prix	1372,29 €
Ecotaxe	2,08€

FOURNITURES ET ACCESSOIRES

- La machine est livrée avec le piétement, le guide de refente, le guide d'onglet, 1 lame largeur 10 mm, le kit de déplacement, clés et notice d'utilisation.

CONSOMMABLES

LEM39 À LEM46
LEM48

P. 142
P. 143



SRU355 (MONOPHASE)
SCIE À RUBAN • 355 MM



- Bâti mécano-soudé rigide et robuste.
- Piètement stable en acier.
- Large berceau de table en fonte d'alü.
- Guide de lame supérieur et inférieur à 3 roulements.
- Réglage de tension de la lame par une molette.
- Brosse de nettoyage sur le volant inférieur, permettant à la lame d'avoir une bonne adhérence.
- Guide de coupe longitudinale avec graduation de chaque côté de la lame.
- Guide d'onglet réglable de - 60° à + 60°, positionnable à droite et à gauche de la lame.
- Contacteur de sécurité sur chaque porte.



Volants en fonte d'acier équilibrés



2 vitesses de coupe, pour bois et métaux non-ferreux

GARANTIE	2
Puissance moteur (230 V - 50Hz)	900W-51
Encombrement (LxlxH)	870 x 750 x 1700 mm
Largeur de coupe	345 mm
Hauteur de coupe	205 mm
Longueur de la lame	2490 mm
Largeur de la lame	6 à 20 mm
Dimensions de la table (LxP)	548 x 400 mm
Inclinaison de la table	0 à 45°
Hauteur de travail (sur piètement)	1020 mm
Diamètre des volants	350 mm
Vitesse de la lame	440 ou 900 m/min
Sortie d'aspiration	ø 100 mm
Poids Net	84 Kg
Référence pour pièces détachées	110200 (+ N°/vue éclatée)
Gencod	3700501700160
Colisage (LxlxH)	1155 x 380 x 520 mm
Poids Brut	91 Kg
Prix	946,39€
Ecotaxe	2,08€

FOURNITURES ET ACCESSOIRES

- La machine est livrée avec le piètement, le guide de refente, le guide d'onglet, 1 lame largeur 16 mm, clés et notice d'utilisation.



LEMAN	€
Kit de déplacement 110201	97,11

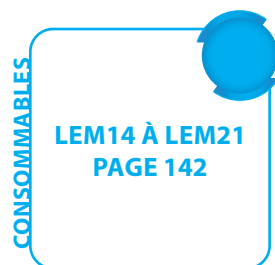



LOSRU250 (MONOPHASE) SCIE À RUBAN • 250 MM



- Bâti mécano-soudé rigide et robuste.
- Socle percé permettant la fixation de la machine sur un piètement ou un établi.
- Sortie d'aspiration Ø60mm à l'arrière de la machine.
- Moteur asynchrone, endurant et silencieux.
- Table de sciage en fonte d'aluminium inclinable à 45°, graduation de chaque côté de la lame.
- Guide de refente positionnable à droite ou à gauche de la lame.
- Guide d'onglet réglable à ±60°, positionnable à droite de la table.
- Guides de lame supérieur et inférieur à 3 roulements.
- Réglage de la tension de la lame par une molette.
- 2 volants en fonte d'aluminium parfaitement usinés et équilibrés, revêtus d'une bande de caoutchouc.
- Brosse de nettoyage sur le volant inférieur, permettant à la lame d'avoir une bonne adhérence.
- Contacteur de sécurité sur chacune des portes.



Volants en fonte d'aluminium équilibrés, et contacteurs de sécurité

GARANTIE	2
Puissance moteur (230 V-50Hz)	350W-S1
Encombrement (LxlxH)	480 x 400 x 815 mm
Largeur de coupe	245 mm
Hauteur de coupe	80 mm
Longueur de la lame	1710 mm
Largeur de la lame	6 à 13 mm
Dimensions de la table (LxP)	300 x 300 mm
Inclinaison de la table	0 à 45°
Hauteur de travail	375 mm
Diamètre des volants	250 mm
Vitesse de la lame	700 m/min
Sortie d'aspiration	ø 60 mm
Poids Net	25 Kg
Référence pour pièces détachées	110000 (+ N°/vue éclatée)
Gencod	3700501700146
Colisage (LxlxH)	800 x 330 x 420 mm
Poids Brut	29 Kg
Prix	373,31€
Ecotaxe	2,08€

FOURNITURES ET ACCESSOIRES

- La machine est livrée avec la table en fonte d'aluminium, le guide de refente, le guide d'onglet, 1 lame largeur 8 mm, clés et notice d'utilisation.



LEMAN	€
Piètement 110001	62,41

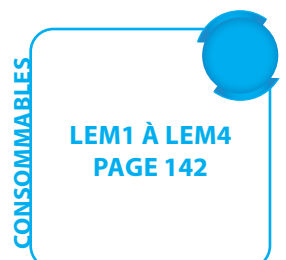

SST315 (MONOPHASE)

SCIE SUR TABLE AVEC INCISEUR ET CHARIOT RAS DE LAME • 315 MM



- Bâti et habillage du carter moteur en mécano-soudé.
- Table de sciage et rallonge droite en fonte d'acier + deuxième rallonge droite et de sortie en mécano-soudé.
- Table du chariot de grandes dimensions avec règle graduée et butée extensible à 2250mm.
- Béquille de renfort permettant une meilleure stabilité de la machine lors de l'usinage de grandes dimensions sur le chariot de coupe.
- Sortie d'aspiration sur le cache lame Ø30mm, reliée au collecteur par un flexible (fourni).



Chariot ras de lame de 2000mm



Lame Ø 315 inclinable à 45° et inciseur de 100mm



Guide de refente avec réglage micrométrique

GARANTIE	2
Puissance moteur (230V-50Hz)	3000W-S1
Encombrement (LxlxH)	3100 x 2850 x 1100 mm
Vitesse de rotation de la lame	4500 T/min
Diamètre de la lame	315 mm
Alésage de la lame	30 mm
Inclinaison de la lame	de 0 à 45° à droite
Diamètre de l'inciseur	100 mm
Alésage de l'inciseur	20 mm
Vitesse de rotation de l'inciseur	8500 T/min
Hauteur de coupe maxi lame 315/250	100/70 mm
Hauteur de coupe à 45° lame 315/250	80/55 mm
Dimensions de la table de sciage + rallonges (L x l)	800 x 1260 mm
Dimensions de la rallonge arrière (L x l)	310 x 500 mm
Dimensions du chariot de coupe (L x l)	2000 x 270 mm
Course de délignage contre la règle	2050 mm
Largeur Maxi de délignage contre le guide	1230 mm
Sortie d'aspiration	100 mm
Poids Net	285 Kg
Référence pour pièces détachées	070800 (+ N°/vue éclatée)
Gencod :	3700501714761
Colisage (LxlxH) :	
- Machine	930 x 760 x 1040 mm
- Chariot	2070 x 310 x 240 mm
Poids Brut	316 Kg
Prix	4611,17€
Écotaxe	2,08€

FOURNITURES ET ACCESSOIRES

- La machine est livrée avec le guide de refente, la butée de délignage, une lame carbure Ø 315 de 40 dents, un inciseur extensible Ø 100 mm de 2x12 dents, les rallonges de table, le presseur, le guide d'onglet, le poussoir, clés et notice d'utilisation.



	LEMAN	€
Kit de déplacement	330201	113,57

CONSOMMABLES

BOIS MASSIF

222.315.3024 P. 76

328.315.3048 P. 78

PANNEAUX ET DÉRIVÉS

336.315.3072 P. 87

338TF.315.96 P. 89

356.100.20212 P. 90

SST256 (MONOPHASE)

SCIE SUR TABLE AVEC CHARIOT RAS DE LAME • 255 MM



- Bâti et habillage du carter moteur en mécano-soudé.
- Table de sciage en fonte d'acier avec rallonge de droite et de sortie en mécano-soudé.
- Table du chariot de grandes dimensions avec règle graduée et butée extensible à 2280 mm.
- Trappe de nettoyage sur l'habillage du carter moteur, permettant d'évacuer les sciures et les chutes de bois gênantes.
- Réglage par deux manivelles indépendantes.
- Sortie d'aspiration sur le cache lame Ø 30 mm, reliée au collecteur par un flexible (fourni).



Chariot ras de lame de 1320mm.
Lame inclinable à 45°



Guide de refente avec réglage micrométrique

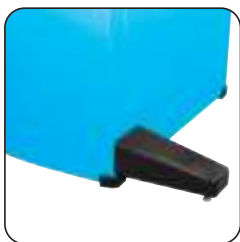

Béquille de renfort du bâti

GARANTIE	2
Puissance moteur (230V-50Hz)	2100W-56/40%
Encombrement (LxlxH)	2260 x 2070 x 1160 mm
Vitesse de rotation de la lame	4060 T/min
Diamètre de la lame	255 mm
Alésage de la lame	30 mm
Inclinaison de la lame	de 0 à 45° à droite
Hauteur de travail	850 mm
Hauteur de coupe maxi	80 mm
Hauteur de coupe à 45°	50 mm
Dimensions de la table de sciage + rallonges (L x l)	1210 x 620 mm
Dimensions du chariot (L x l)	1320 x 238 mm
Dimensions de la table du chariot (L x l)	600 x 400 mm
Course de délignage contre la règle	1200 mm
Largeur Maxi de délignage	610 mm
Sortie d'aspiration	100 mm
Poids Net	152 Kg
Référence pour pièces détachées	070400 (+ N°/vue éclatée)
Gencod :	3700501706254
Colisage (LxlxH) :	
- Machine	860 x 625 x 570 mm
- Chariot	1380 x 380 x 130 mm
- Table du chariot	890 x 515 x 150 mm
- Rallonge de table	805 x 305 x 55 mm
Poids Brut	165 Kg
Prix	2378,97€
Ecotaxe	2,08€

FOURNITURES ET ACCESSOIRES

- La machine est livrée avec le guide de refente, le chariot latéral, la butée de délignage, une lame carbure 36 dents, les rallonges de table, le poussoir, clés et notice d'utilisation.



OPTION

LEMAN	€
Kit de déplacement 070410	117,51

CONSOMMABLES

BOIS MASSIF	
222.250.3024	P. 76
334.250.3048	P. 78
PANNEAUX ET DÉRIVÉS	
336.250.3060	P. 87
338TF.250.80	P. 89

LOSST315 (MONOPHASE)

SCIE SUR TABLE TRANSPORTABLE À CHARIOT • 315 MM



2200W



54 Kg



- Piètement en acier, repliable sans outil pour faciliter le stockage ou le transport sur les chantiers.
- Kit composé de 2 roulettes et de 2 manettes escamotables pour un déplacement aisé de la machine.
- Puissant moteur asynchrone de 2200W, endurant et silencieux, sortie d'aspiration Ø100mm au niveau du carter moteur.
- Prise d'aspiration sur le protège-lame, reliée au collecteur de sciures par un flexible (fourni).
- Trappe de nettoyage située sous le carter moteur afin d'évacuer les sciures et les chutes de bois.
- Table de sciage en acier galvanisé, rallonge de table arrière 550x800mm en acier galvanisé, munie de 2 renforts.
- Lame réglable en hauteur par une manivelle, et inclinable jusqu'à 45° à droite par une molette.
- Guide de coupe longitudinal avec poignée de serrage excentrique, graduation de chaque côté de la lame.
- Table de chariotage avec coulissement sur rail grâce à 3 galets.
- Guide d'onglet monté sur la table de chariotage, réglable à ±45° et équipé d'une butée de longueur pour les coupes répétitives.



Lame inclinable à 45 et réglable en hauteur°

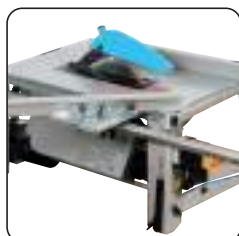

Piètement repliable

GARANTIE	2
Puissance moteur (230 V - 50Hz)	2200W-S6/20%-5min
Encombrement (LxlxH)	915 x 1999 x 900 mm
Vitesse de rotation	2800 t/min
Diamètre de la lame	315 mm
Alésage de la lame	30 mm
Inclinaison de la lame	de 0° à 45° à droite
Hauteur de travail	855 mm
Hauteur de coupe Maxi	83 mm
Hauteur de coupe à 45°	58 mm
Sortie d'aspiration	Ø 100 mm
Dimensions de la table (lxP)	550 x 800 mm
Dimensions de la rallonge (lxP)	550 x 800 mm
Dimensions du guide (LxH)	580 x 60 mm
Poids Net	54 Kg
Référence pour pièces détachées	070100 (+ N°/vue éclatée)
Gencod	3700501700078
Colisage (LlxH)	
- Machine	940 x 650 x 470 mm
- Chariot	1280 x 240 x 140 mm
Poids Brut	65 Kg
Prix	770,76€
Ecotaxe	2,08€

FOURNITURES ET ACCESSOIRES

- La machine est livrée avec le guide de refente, le guide d'onglet, 1 lame carbure en 24 dents, le chariot latéral, la rallonge de table arrière en mécano-soudé, le kit de déplacement, clés et notice d'utilisation.



OPTION

LEMAN	€	LEMAN	€
Rallonge latérale 070101	65,96	Règle pour extension de table 070102	29,19

CONSOMMABLES

BOIS MASSIF
222.315.3024 P. 76
328.315.3048 P. 78
PANNEAUX ET DÉRIVÉS
336.315.3072 P. 87
MULTI-MATÉRIAUX
223.315.3020 P. 95
224.315.3048 P. 96

RAD310 (MONOPHASE) - RAD310T (TRIPHASE) DÉGAUCHISSEUSE - RABOTEUSE • 310 MM



- Bâti mécano-soudé rigide et robuste.
- Tables de dégauchissage en fonte d'acier avec lèvres anti-bruit, ajustables et d'une longueur totale de 1800 mm.
- Guide en aluminium profilé, monté sur une glissière queue d'aronde en fonte d'acier, inclinable à 45°.
- Passage en rabotage en relevant les tables, nul besoin de démonter le guide. Ouverture papillon grâce à de puissantes charnières. Indicateur de position pour hauteur de rabotage.
- Table de rabotage en fonte d'acier montée sur 1 fût central Ø 110 mm et maintenue en sortie par un 2ème fût.
- Avance automatique débrayable. Option mortaiseuse, mandrin de 16 mm, filetage M20x1,5, rotation à gauche.



Table de rabotage montée sur 2 fûts

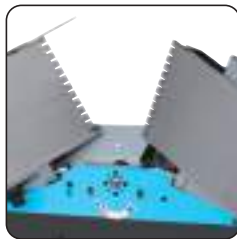

Ouverture papillon



Rouleaux d'entraînement ø 40 mm pour l'avance de la pièce de bois. Arbre de 95 mm à 4 fers



Entraînement des rouleaux par chaîne. Entraînement moteur à double courroie.

GARANTIE	2
Puissance moteur (230 V /400V - 50Hz)	2200W-51
Encombrement (LxHxh)	1800 x 890 x 970 mm
Vitesse de rotation de l'arbre	4000 t/min
Diamètre de l'arbre	95 mm
Nombre de fers	4
Dimensions des fers (mm)	310 x 30 x 3,0
Filetage de l'arbre pour adaptation mandrin	M20 x 1,5 mm
Diamètre des rouleaux d'entraînement	40 mm
Sortie d'aspiration	ø 100 mm
DÉGAUCHISSAGE	
Largeur de dégauchissage	310 mm
Dimensions des tables (Lxl)	1800 x 315 mm
Dimensions du guide (LxH)	1115 x 150 mm
Inclinaison du guide	de 90° à 135°
Profondeur de passe	de 0 à 3 mm
Hauteur de travail	820 mm
RABOTAGE	
Largeur de rabotage	310 mm
Hauteur de rabotage	220 mm
Profondeur de passe	jusqu'à 3 mm
Vitesse d'avance	8 m/min
Dimensions de la table (Lxl)	750 x 310 mm
Poids Net	310 Kg
Référence pour pièces détachées	
- Mono	210200 (+ N°/vue éclatée)
- Tri	210300 (+ N°/vue éclatée)
Gencod	
- Mono	3700501700313
- Tri	3700501705448
Colisage (LxlxH)	1880 x 620 x 920 mm
Poids Brut	350 Kg
Prix	3103,65€
Ecotaxe	2,08€

FOURNITURES ET ACCESSOIRES

- La machine est livrée avec le guide de dressage inclinable, 4 fers en acier, 1 calibre de réglage des fers, l'indicateur de position, 1 poussoir, clés et notice d'utilisation.



LEMAN €

Kit de déplacement 210101 142,69



LEMAN €

Mortaiseuse 210220 510,19

CONSOMMABLES

031.30.302 P. 293
380.700.096 P. 292
322.500.01 P. 323

RAD250 (MONOPHASE)

DÉGAUCHISSEUSE - RABOTEUSE • 250 MM



1500W



148 Kg



- Bâti mécano-soudé rigide et robuste.
- Table de dégauchissage en fonte d'acier avec lèvres anti-bruit, ajustable et d'une longueur totale de 1080 mm.
- Guide en aluminium profilé monté sur une glissière queue d'aronde en fonte d'acier, rigide et largement dimensionné, inclinable à 45°.
- Indicateur de position pour hauteur de rabotage. Avance automatique débrayable.
- Option mortaiseuse, mandrin de 16 mm, filetage M20x1,5, rotation à gauche.



Table de rabotage montée sur 2 fûts

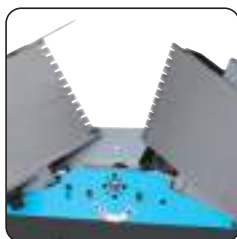

Ouverture papillon



Entraînement des rouleaux par chaîne. Entraînement moteur à double courroie

GARANTIE	2
Puissance moteur (230 V - 50Hz)	1500W-S1
Encombrement (LxlxH)	1080 x 550 x 1010 mm
Vitesse de rotation de l'arbre	4000 t/min
Diamètre de l'arbre	75 mm
Nombre de fers	3
Dimensions des fers (mm)	250 x 30 x 3,0
Filetage de l'arbre pour adaptation mandrin	M20 x 1,5 mm
Diamètre des rouleaux d'entraînement	32 mm
Sortie d'aspiration	ø 100 mm
DÉGAUCHISSAGE	
Largeur de dégauchissage	250 mm
Dimensions des tables (Lxl)	1080 x 255 mm
Dimensions du guide (LxH)	720 x 130 mm
Inclinaison du guide	90° et 135°
Profondeur de passe	de 0 à 3 mm
Hauteur de travail	830 mm
RABOTAGE	
Largeur de rabotage	250 mm
Hauteur de rabotage	180 mm
Profondeur de passe	jusqu'à 3 mm
Vitesse d'avance	8 m/min
Dimensions de la table (Lxl)	600 x 250 mm
Poids Net	148 Kg
Référence pour pièces détachées	210100 (+ N°/vue éclatée)
Gencod	3700501700306
Colisage (LxlxH)	1150 x 530 x 920 mm
Poids Brut	176 Kg
Prix	1870,58€
Ecotaxe	2,08€

FOURNITURES ET ACCESSOIRES

- La machine est livrée avec guide de dressage inclinable, 3 fers en acier, 1 calibre de réglage des fers, l'indicateur de position, 1 poussoir, clés et notice d'utilisation.

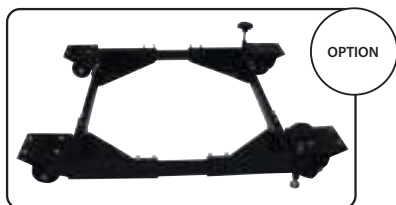

LEMAN €
Kit de déplacement 210101 142,69



LEMAN €
Mortaiseuse 270110 424,71

CONSOMMABLES

025.30.302 P. 293
380.700.075 P. 292
322.500.01 P. 323

RAD260 (MONOPHASE)

DÉGAUCHISSEUSE - RABOTEUSE • 260 MM



- Bâti en fonte d'aluminium, ce qui donne une machine légère et robuste.
- Tables de dégauchissage en fonte d'aluminium avec lèvres anti-bruit, d'une longueur totale de 1035 mm.
- Guide en aluminium profilé inclinable de 45°, rigide et largement dimensionné.
- Collecteur de copeaux amovible pour servir en dégauchissage et en rabotage, avec sortie d'aspiration Ø100 mm.
- Il doit être positionné de façon à appuyer sur le contacteur de sécurité en mode dégauchissage pour que la machine démarre.



Table de rabotage en fonte d'acier sur 4 vérins filetés



Rouleaux d'entraînement pour l'avance de la pièce de bois



Contacteur de sécurité

GARANTIE	2
Puissance moteur (230 V - 50Hz)	2000W-51
Encombrement (LxH)	1100 x 600 x 950 mm
Vitesse de rotation de l'arbre	6500 t/min
Diamètre de l'arbre	63 mm
Nombre de fers	2
Dimensions des fers (mm)	260 x 18 x 1,2
Sortie d'aspiration	ø 100 mm
DÉGAUCHISSAGE	
Largeur de dégauchissage	260 mm
Dimensions des tables (Lxl)	1035 x 280 mm
Dimensions du guide (LxH)	610 x 110 mm
Inclinaison du guide	de 90° à 135°
Profondeur de passe	de 0 à 3,0 mm
Hauteur de travail	850 mm
RABOTAGE	
Largeur de rabotage	255 mm
Hauteur de rabotage	160 mm
Profondeur de passe	jusqu'à 3 mm
Vitesse d'avance	5 m/min
Dimensions de la table (Lxl)	400 x 260 mm
Poids Net	65 Kg
Référence sur pièces détachées	210000 (+ N°/vue éclatée)
Gencod	3700501700290
Colisage (LxH)	710 x 570 x 560 mm
Poids Brut	72 Kg
Prix	1386,23€
Ecotaxe	2,08€

FOURNITURES ET ACCESSOIRES

- La machine est livrée avec le piètement, le guide de dressage inclinable, 2 fers réversibles en acier, 1 calibre de réglage des fers, clés et notice d'utilisation.



	LEMAN	€
Kit de déplacement	210001	77,59



	LEMAN	€
260 18 1,2 Acier , 2 coupes réversibles	210002	24,84

LODRA260 (MONOPHASE)
DÉGAUCHISSEUSE - RABOTEUSE • 260 MM

- Machine transportable, idéale pour les chantiers et le travail sur site.
- Socle percé pour pouvoir fixer la machine sur le piètement fourni ou sur un établi, les 4 patins en caoutchouc permettent d'absorber les vibrations.
- Tables de dégauchissage en fonte d'aluminium parfaitement rectifiées, avec lèvres anti-bruit.
- Guide de dégauchissage en profilé aluminium, inclinable à 45°.
- Avance automatique par 2 rouleaux d'entraînement en mode rabotage, avec peigne anti-recul.
- Collecteur de copeaux amovible servant en rabotage et dégauchissage. Il actionne les contacteurs de sécurité dans les deux modes de travail.



Guide en profilé aluminium inclinable à 45°

GARANTIE	2
Puissance moteur (230 V - 50Hz)	1500 W (charbon) - S1
Encombrement (LxlxH)	960 x 515 x 1100 mm
Vitesse de rotation	9000 t/min
Diamètre de l'arbre	50 mm
Nombre de fers	2
Dimensions des fers	260 x 16,5 x 1,5 mm (1 coupe)
Diamètre des rouleaux d'entraînement caoutchouc	25 mm
Sortie d'aspiration	100 mm
DEGAUCHISSAGE	
Largeur de dégauchissage	260 mm
Dimensions des tables (Lxl)	920 x 265 mm
Dimensions du guide (LxH)	635 x 125 mm
Inclinaison du guide	de 90° à 135°
Profondeur de passe	De 0 à 2 mm
Hauteur de travail (sur piètement)	970 mm
RABOTAGE	
Largeur de rabotage	255 mm
Hauteur de rabotage	de 5 à 120 mm
Longueur max de rabotage	1000 mm
Profondeur de passe	jusqu'à 3 mm
Vitesse d'avance	6 m/min
Dimension de la table (Lxl)	270 x 303 mm
Poids Net	33,5 Kg
Référence pour pièces détachées	210600 (+ N°/vue éclatée)
Gencod	3700501707817
Colisage (LxlxH) - Machine	1020 x 510 x 440 mm
Poids Brut	39 Kg
Prix	638,08€
Ecotaxe	2,08€

FOURNITURES ET ACCESSOIRES

- La machine est livrée avec le piètement, le guide inclinable, 2 fers en acier HSS 18 %, le réglage de fer, les poussoirs, clés et notice d'utilisation.



260 16,5 1,5 Acier HSS 18% - 1 Coupe 210601 27,60

LEMAN €

LODRA210

DÉGAUCHISSEUSE - RABOTEUSE • 210 MM



- Machine transportable, idéale pour les chantiers et le travail sur site (charpentiers, poseurs, menuisiers)
- Système d'aspiration intégré avec sac de récupération des copeaux
- Tiroir de rangement pour accessoires
- Tables de dégauchissage rectifiées en fonte d'aluminium, avec lèvres anti-bruit
- Table de rabotage en acier galvanisé
- Guide de dégauchissage en profilé aluminium, inclinable jusqu'à 45°



Guide en profilé aluminium inclinable à 45°



Système d'aspiration intégré (avec sac de récupération)

Tension/Fréquence	230 V / 50 Hz
Puissance Moteur (à Charbons)	1500 W - S1
Vitesse de Rotation	8500 t/min
Diamètre Arbre	Ø50 mm
Nombre de Fers	2
Dimensions des Fers	210 x 22 x 1,8mm 1 Coupe
Sortie Aspiration	Ø60 mm
Largeur de Dégauchissage	210 mm
Dimensions des Tables	730 x 210 mm
Dimensions du Guide	530 x 102 mm
Inclinaison du Guide	90° à 135°
Profondeur de Passe	jusqu'à 2 mm
Largeur de Rabotage	210 mm
Hauteur de Rabotage	6 à 210 mm
Dimensions de la Table	285 x 204 mm
Profondeur de Passe	2 mm
Pression Acoustique LpA	95,5 dB(A) à vide
Puissance Acoustique LwA	108,5 dB(A) à vide
Poids Net	27,1 kg
Poids Brut	31,1 kg
Dimensions Colisage	820 x 530 x 535 mm
Racine Pièces Détachées	210700
Gencod	3661589102553
Prix	525,80€
Ecotaxe	2,08€

FOURNITURES ET ACCESSOIRES

• La machine est livrée avec un sac de récupération des poussières, 2 fers en acier, un tuyau flexible 0,75 m, 3 colliers de serrage, un poussoir, une courroie de rechange, clés de service et notice d'utilisation.



				LEMAN	€
210	22	1,8	Acier HSS 18% - 1 Coupe (paire)	210701	22,89
			Piètement	210702	56,70

LORAB330 RABOTEUSE • 330 MM



1500W



30,7 Kg



- Machine très simple d'utilisation, idéale pour les chantiers et le travail sur site (charpentiers, poseurs, menuisiers)
- Table de rabotage en acier galvanisé avec rallonge repliable en entrée et en sortie
- Poignées de transport intégrées
- Sortie d'aspiration réversible avec adaptateurs
- Jauge de profondeur de passe



Table de rabotage en acier galvanisé







Jauge de profondeur de passe

Tension/Fréquence	230 V / 50 Hz
Puissance Moteur (à Charbons)	1500 W - S1
Vitesse de Rotation	8500 t/min
Diamètre Arbre	48 mm
Nombre de Fers	2
Dimensions des Fers	330 x 12 x 1,5 mm 2 coupes réversibles
Sortie Aspiration	Ø53 mm avec adaptateurs
Largeur de Rabotage	330 mm
Hauteur de Rabotage	152 mm
Dimensions de la Table	330 x 235 mm
Profondeur de Passe	de 0,5 à 3,0 mm
Vitesse d'Avance	6 m/min
Pression Acoustique LpA	83,8 dB(A) à vide
Puissance Acoustique LwA	96,8 dB(A) à vide
Poids Net	30,7 kg
Poids Brut	33,1 kg
Encombrement	630 x 560 x 550 mm
Dimensions Colisage	620 x 410 x 475 mm
Racine Pièces Détachées	210800
Gencod	3661589102546
Prix	465,92€
Ecotaxe	2,08€

FOURNITURES ET ACCESSOIRES

- La machine est livrée avec adaptateurs Ø65 & 100 mm, 2 fers en acier, clés de service et notice d'utilisation.



				LEMAN	€
330	12	1,5	Acier HSS 18% - 2 coupes réversibles (paire)	210801	49,67



MOR750 (MONOPHASE) MORTAISEUSE À BÉDANE • 750 W



- Base, colonne, tête, chariots et guide en fonte d'acier.
- Vérin à gaz permettant de maîtriser les mouvements de descente et de remontée de la tête.
- Rotation de la colonne sur sa base à 180°, afin de pouvoir travailler hors table.
- Butées de chariotage latéral avec graduation.
- Butées de profondeur de mortaisage avec graduation.
- 1 butée de longueur réglable pour les travaux répétitifs.
- Armoire métallique de rangement avec 1 étagère et porte fermant à clé.



Coulissement de la tête sur queue d'aronde



2 presseurs verticaux à serrage rapide et 1 presseur horizontal coulissant



Double chariotage latéral et longitudinal sur queue d'aronde

GARANTIE	2
Puissance moteur (230 V - 50HZ)	750W-S1
Encombrement (Lxlxh)	480 x 600 x 1790 mm
Vitesse de rotation	2800 t/min
Capacité de serrage du mandrin	3 à 16 mm
Diamètre de queue de bédane	15,9 mm
Bédane adaptable	6 à 16 mm
Dimensions de la table (LxP)	400 x 150 mm
Dimensions du guide (LxH)	400 x 50 mm
De l'axe de la bédane au guide (max)	140 mm
Course de la tête	235 mm
Sous les presseurs verticaux (max)	195 mm
Chariotage latéral	170 mm
Chariotage en profondeur	155 mm
Poids Net	124 kg
Référence pour pièces détachées	170100 (+ N°/vue éclatée)
Gencod	3700501700252
Colisage (LxlxH)	- Machine 560 x 470 x 760 mm
	- Armoire 500 x 400 x 640 mm
Poids Brut	131 Kg
Prix	1105,51€
Ecotaxe	2,08€

FOURNITURES ET ACCESSOIRES

- La machine est livrée avec l'armoire de rangement, les presseurs verticaux, la butée de longueur, 2 mèches à bédane de 8 et 10 mm, douille de 15,9, clés et notice d'utilisation.



CONSOMMABLES

306.500.04
PAGE 322

Adaptateur de perçage mandrin ø 16 MM	LEMAN	€
	170101	46,99



MOR375 (MONOPHASE)

MORTAISEUSE À BÉDANE D'ÉTABLI • 550 W



- Base, colonne et tête de mortaiseuse en fonte d'acier.
- Colonne avec coulissement de la tête sur queue d'aronde.
- Vérin à gaz permettant de maîtriser les mouvements de descente et de remontée de la tête.
- Butée de chariotage latéral.
- Butée de profondeur de mortaisage réglable.
- Presseur horizontal permettant de maintenir la pièce de bois avec serrage par manivelle.
- Base percée pour fixation de la machine sur un établi.



Chariotage latéral et longitudinal sur queue d'aronde



Système de mandrin pour fixation de la mèche

GARANTIE	2
Puissance moteur (230V-50Hz)	550W-S1
Encombrement (LxlxH)	350 x 350 x 800 mm
Vitesse de rotation	2800 T/min
Capacité de serrage du mandrin	de 3 à 13 mm
Diamètre de queue de bédane	15,9 mm
Bédane adaptable	6 à 12 mm
Dimension de la table (LxP)	180 x 157 mm
Dimension du guide (LxH)	180 x 50 mm
Dimension du socle (LxP)	320 x 270 mm
De l'axe de la bédane au guide (Max)	70 mm
Course de la tête	120 mm
Chariotage latéral	170 mm
Profondeur de la mortaise (maxi avec bédane de 12 mm)	70 mm
Poids Net	42 Kg
Référence pour pièces détachées	170300 (+ N°/vue éclatée)
Gencod	3700501706216
Collisage (LxlxH)	670 x 450 x 340 mm
Poids Brut	46 Kg
Prix	612,33€
Écotaxe	2,08€

FOURNITURES ET ACCESSOIRES

- La machine est livrée avec 2 mèches à bédanes de 8 et 10 mm, douille 15,9, clés et notice d'utilisation.



LEMAN	€
Adaptateur de perçage mandrin ø 13 MM	170001 26,25

CONSOMMABLES

306.500.04
PAGE 322

TOU030 (MONOPHASE) - TOU030T (TRIPHASE)

**TOUPIE EN ARBRE DE 30 MM
AVEC CHARIOT • 30 MM**



- Bâti robuste en acier mécano-soudé.
- Table de toupillage en fonte d'acier avec une ouverture pour des outils jusqu'à 180 mm de diamètre. Pré-perçage pour le montage d'un entraîneur, puits de profondeur 100 mm avec une sortie d'aspiration Ø 56/ 50 mm (adaptateur fourni).
- 4 vitesses de rotation dont 1 lente (1800 t/min) pour le ponçage. Indication de la vitesse par un voyant lumineux, changement de vitesse en modifiant la position de la courroie sur les poulies.
- Capot de toupie en fonte d'acier avec sortie d'aspiration Ø 100 mm, presseur horizontal et presseur vertical à galets.
- Table de chariotage en aluminium avec presseur vertical à serrage excentrique, guide d'angle, règle de grande dimension (extensible jusqu'à 1500 mm), butée de longueur avec réglage micrométrique équipée d'une règle à tenonner. La table de chariotage est démontable en un tour de main, sans outil.



Guide de toupie avec presseurs horizontal et vertical.



Chariot de tenonnage avec coulissement sur roulements à billes.



4 vitesses de rotation

GARANTIE	2
Puissance moteur (230/400 V - 50HZ)	2800W-S1
Encombrement (Lxlxh)	1900 x 1200 x 1250 mm
Vitesse de rotation du moteur	2800t/min
Vitesse de rotation de l'arbre	1800-3000-6000-9000t/min
Diamètre de l'arbre	30 mm
Filetage de l'arbre	M14
Hauteur de l'arbre	100 mm
Course de l'arbre	100 mm
Ø maximum de l'outil dans la table	180 mm
Profondeur du puits	100 mm
Ø maxi de l'outil dans le capot	200 mm
Sortie d'aspiration	Ø 100 mm
Dimensions de la table (LxP)	690 x 480 mm
Hauteur du travail	900 mm
Table de chariotage (LxP)	500 x 480 mm
Longueur du rail	1250 mm
Course du chariot	810 mm
Guide d'angle	de - 45° à + 45°
Poids Net	173 Kg
Référence pour pièces détachées	
- Mono	250000 (+ N°/vue éclatée)
- Tri	250100 (+ N°/vue éclatée)
Gencod	
- Mono	3700501700337
- Tri	3700501700344
Colisage (LxPxH) - Machine	730 x 520 x 680 mm
- Table chariot	510 x 480 x 300 mm
- Rail chariot	1240 x 300 x 100 mm
Poids Brut	191 Kg
Prix	2643,92€
Ecotaxe	2,08€

FOURNITURES ET ACCESSOIRES

- La machine est livrée avec les presseurs, la table et la règle de tenonnage, cylindre ponçeur (Hauteur 120 - grain 100), guide d'angle et règle extensible, des bagues de remplissage et de réglage, des bagues de lumière de table, adaptateur d'aspiration, clés et notice d'utilisation.



	LEMAN	€
Kit de déplacement	330201	113,57
Capot de tenonnage	270003	137,31
Rallonge de table	250006	65,04

	LEMAN	€
Guide à barettes	250003	141,28
Guide pour travail à l'arbre	250004	194,53



CONSOMMABLES

PAGE 240

ENT032 (MONOPHASE)
ENTRAÎNEUR



- L'entraîneur permet une avance régulière du bois, tout en apportant un maximum de sécurité.
- 4 vitesses d'entraînement fixes en avant et en arrière, par changement des pignons.
- Engrenages interchangeables en carbure fritté, carbonitrurés et traités.
- Peinture à poudre électrostatique, très résistante et très protectrice.
- Possibilité de travailler à 90° pour l'avance de pièce de bois sur chant contre le guide (l'utilisation d'un guide à barrettes est conseillée).
- Volant manivelle avec vis sans fin pour le réglage horizontal et vertical des tiges en rond d'acier de Ø 40 mm.



Entraînement par chaîne



Bras rallongé de 610 mm



3 Rouleaux ø 80

GARANTIE	2
Puissance moteur (230V - 50Hz)	185 W - S1
Encombrement (LxlxH)	1040 x 350 x 600 mm
Sens de rotation	Avant et arrière
Vitesses d'entraînement	4 - 8 - 9 - 18 m/min
Nombre de rouleaux	3
Diamètre des rouleaux	80 mm
Largeur des rouleaux	28 mm
Épaisseur du caoutchouc des rouleaux	14 mm
Course de suspension des rouleaux	15 mm
Course du bras	425 mm
Course de la potence	150 mm
Hauteur maxi de la pièce à usiner	150 mm
Poids Net	30 kg
Référence pour pièces détachées	250200 (+ N°/vue éclatée)
Gencod	3700501704984
Collisage (LxlxH)	700 x 580 x 280 mm
Poids Brut	37 Kg
Prix	811€
Écotaxe	2,08€

FOURNITURES ET ACCESSOIRES

- L'entraîneur est livré avec les 3 rouleaux caoutchouc de ø 80 mm, le bras rallongé de 610 mm et la notice d'utilisation.



	LEMAN	€
Rouleau caoutchouc, ø 80 mm	250200.005	26,43

LOTDE040 (MONOPHASE)

DÉFONCEUSE STATIONNAIRE • 40 MM



- Machine transportable, idéale pour les chantiers et le travail sur site.
- Machine d'appoint combinant la facilité d'utilisation d'une défonceuse et le confort de travail d'une toupie.
- Socle percé permettant la fixation de la machine sur un piétement ou un établi.
- Table en fonte d'acier avec rallonges en tôle mécano-soudée.
- Guide en profilé aluminium réglable en profondeur, presseurs vertical et horizontal, capot de protection transparent et sortie d'aspiration Ø100mm.
- Guide d'onglet réglable à ±60°.
- Hauteur de fraisage réglable par manivelle, variateur de vitesses électronique.



Table en fonte d'acier



5 pinces de serrage
(6- 6,35-8-12-12,7 mm)

GARANTIE	2
Puissance moteur (230 V - 50Hz)	1500 W (charbon) - S1
Encombrement (LxlxH)	1030 x 670 x 550 mm
Variateur	Oui
6 Vitesses de rotation	de 11500 à 24000 T/min
	1: 11500 T/min
	2: 13500 T/min
	3: 15500 T/min
	4: 17500 T/min
	5: 20000 T/min
	6: 24000 T/min
Dimensions de la table en fonte d'acier (Lxl)	610 x 360 mm
Dimensions des rallonges de table en mécano (Lxl)	2 de 210 x 360 mm
Dimensions totales de la table de travail	1030 x 360 mm
5 pinces de serrage	6 - 6,35 - 8 - 12 - 12,7 mm
Diamètre du puits	80 mm
Diamètre maxi de la mèche	55 mm
Hauteur de réglage	de 0,1 à 40 mm
Hauteur de travail	315 mm
Dimensions du guide (LxH)	700 x 75 mm
Sortie d'aspiration	100 mm
Poids Net	30 kg
Référence pour pièces détachées	250500 (+ N°/vue éclatée)
Gencod	3700501707824
Colisage (LxlxH)	660 x 520 x 380 mm
Poids Brut	32 Kg
Prix	444,27€
Ecotaxe	2,08€

FOURNITURES ET ACCESSOIRES

- La machine est livrée avec les protecteurs, 5 pinces de serrage (6- 6,35-8-12-12,7 mm), le guide d'onglet, les bagues de remplissage, les 2 rallonges de table en mécano-soudé, clés et notice d'utilisation.

CONSOMMABLES

PAGE 193

COM310 (MONOPHASE) - COM310T (TRIPHASE)
COMBINÉ 5 FONCTIONS • 310 MM



Rallonge de table en fonte d'acier et fixation basculante pour entraîneur.

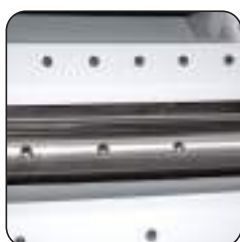

Arbre de dégauchissage de Ø70mm avec 3 fers 310x25x3.



Chariot ras de lame 2000mm, lame Ø315 ou Ø250, inciseur Ø100mm.



Toupie avec 4 vitesses de rotation.

- Vous pouvez adapter un inciseur conique ou extensible Ø100 mm en changeant le diamètre de votre lame principale 315 mm par une lame de 250 mm. En adaptant un inciseur vous pourrez alors déligner des panneaux et ainsi éviter les éclats pour les travaux de finition.
- Le sélecteur du sens de rotation en mode toupillage permet de travailler en avalant sous la seule condition d'utiliser un entraîneur.
- Le guide de dressage de dégauchisseuse renforcé offre une bonne rigidité.
- Les tables en fonte d'acier ouvrant à l'intérieur assurent la stabilité de la machine pour un travail précis.
- Ses servantes à rouleaux positionnées en bout de table de rabotage et de chariotage facilitent le déplacement des pièces de bois.
- Bâti en mécano-soudé avec renfort en fonte d'acier sur les parties à ouverture.
- La machine peut être séparée pour entrer dans les endroits étroits (bloc scie = 700 mm et bloc RAD = 580 mm).

GARANTIE	2	DÉGAUCHISSAGE	
Encombrement (LxlxH)	3200 x 2900 x 1200 mm	Largeur de dégauchissage	310 mm
Hauteur de travail	860 mm	Profondeur de passe	de 0 à 5 mm
SCIE		Dimensions des tables	1380 x 315 mm
Puissance moteur (230V/400V - 50Hz)	3000W / 3800W S1	Dimension du guide	1380 x 150 mm
Vitesse de rotation lame/inciseur	4500 T/min / 8500T/min	Inclinaison du guide	de 45° à 90°
Diamètre et alésage de la lame (mm)	315 x 30 / 250 x 30 mm	RABOTAGE	
Diamètre et alésage de l'inciseur (mm)	- / 100 x 20 mm	Largeur de rabotage	305 mm
Inclinaison de la lame	45°	Hauteur de rabotage	225 mm
Hauteur de coupe maxi	100 mm / 70 mm	Profondeur de passe	de 0 à 3 mm
Hauteur de coupe à 45°	80 mm / 55 mm	Vitesse d'avance	6 m/min
Dimension de la table (LxP)	860 x 300 mm	Dimension de la table (Lxl)	540 x 306 mm
Dimension de la rallonge (LxP)	505 x 300 mm	MORTAISEUSE (OPTION)	
Dimension du chariot de coupe (Lxl)	2000 x 270 mm	Mandrin type Wescott	0 à 16 mm
TOUPIE/TENONNEUSE		Dimension de la table	500 x 210 mm
Puissance moteur (230V/400V - 50Hz)	2800W S1	Hauteur de Mortaisage	140 mm
Vitesses de rotation	1800-3000-6000-9000	Course longitudinale	290 mm
Diamètre de l'arbre	30 mm	Course latérale	150 mm
Filetage de l'arbre	M14	Sortie d'aspiration du combiné	3 x ø100 mm
Hauteur de l'arbre	100 mm	Poids Net	565 Kg
Diamètre Maxi de l'outil dans la table / le capot	200 mm	Référence pour pièces détachées:	
Table de chariotage (L/l)	860 x 300 mm	- Mono	270000(+ N°/vue éclatée)
DÉGAUCHISSEUSE / RABOTEUSE		- Tri	270200(+ N°/vue éclatée)
Puissance moteur (230V/400V - 50Hz)	3000W / 3800W S1	Gencod:	
Vitesse de rotation	4800 T/min	- Mono	3700501705219
Diamètre de l'arbre	70 mm	- Tri	3700501705998
Dimensions des fers	310 x 25 x 3 mm	Colisage (LxlxH):	
Nombre de fers	3	- Machine	1570 x 1220 x 985 mm
		- Chariot	2100 x 320 x 245 mm
		Poids Brut	679 Kg
		Prix	8671,66€
		Ecotaxe	2,08€

FOURNITURES ET ACCESSOIRES

• La machine est livrée avec 1 lame carbure ø 315 de 40 dents, 3 fers de coupe, les presseurs, le guide d'onglet, le chariot latéral avec sa règle graduée, les bagues de remplissage et de réglage, les bagues lumière de table, 1 rouleau ponceur (hauteur 120 - grain 100), le guide pour le travail à l'arbre, 1 fixation basculante d'entraîneur, la règle à tenonner, clés et notice d'utilisation.



	LEMAN	€
Fixation basculante d'entraîneur	270001	112,34
Guide à barettes	250003	141,28
Guide pour travail à l'arbre	250004	194,03



	LEMAN	€
Kit de déplacement	270002	221,75



	LEMAN	€
Mortaiseuse	270010	554,49



	LEMAN	€
Capot de tenonnage	270003	137,31

CONSOMMABLES

BOIS MASSIF

222.315.3024 P. 76

328.315.308 P. 78

PANNEAUX ET DÉRIVÉS

336.250.3060 P. 87

338TF.250.80 P. 89

356.100.20212 P. 90

357.100.2018 P. 90

LEMAMAXIMUM P. 242

031.25.302 P. 293

322.500.01 P. 323

COM250 (MONOPHASE)
COMBINÉ 5 FONCTIONS • 250 MM



Lame \varnothing 250 mm et inciseur \varnothing 80 mm



Arbre de dégauchissage de \varnothing 75 mm avec 3 fers 250x30x3

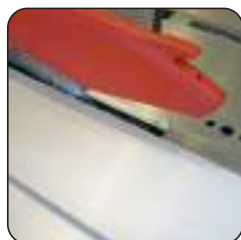

Chariot ras de lame de 1200 mm



Toupie avec 3 vitesses de rotation

- Elle est munie d'un inciseur \varnothing 80 mm qui permet de déligner des panneaux et ainsi éviter les éclats pour les travaux de finition. Vous pouvez adapter un inciseur conique si vous le souhaitez.
- Le guide de dressage de dégauchisseuse renforcé offre une bonne rigidité.
- Les tables en fonte d'acier assurent la stabilité de la machine pour un travail précis.
- Bâti en mécano-soudé avec renfort en fonte d'acier sur les parties à ouverture.
- La machine peut être séparée pour entrer dans les endroits étroits (bloc scie = 620 mm et bloc RAD = 500 mm).

GARANTIE	2	DÉGAUCHISSAGE	
Encombrement (Lxlxh)	1200 x 940 x 970 mm	Largeur de dégauchissage	250 mm
Hauteur de travail	850 mm	Profondeur de passe	de 0 à 5 mm
SCIE		Dimensions des tables	1090 x 255 mm
Puissance moteur (230V - 50Hz)	3000W S1	Dimension du guide	720 x 130 mm
Vitesse de rotation lame/inciseur	4050 / 6300 T/min	Inclinaison du guide	de 45° à 90°
Diamètre et alésage de la lame (mm)	250 x 30 mm	RABOTAGE	
Diamètre et alésage de l'inciseur (mm)	80 x 20 mm	Largeur de rabotage	245 mm
Inclinaison de la lame	45°	Hauteur de rabotage	180 mm
Hauteur de coupe maxi	60 mm	Profondeur de passe	de 0 à 2,5 mm
Hauteur de coupe à 45°	42 mm	Vitesse d'avance	4,8 m/min
Dimension de la table (Lxl)	1115 x 600 mm	Dimension de la table (Lxl)	600 x 250 mm
Dimension du chariot de coupe (Lxl)	1200 x 240 mm	MORTAISEUSE/PERCEUSE (OPTION)	
Course de délignage	1030 mm	Mandrin type Wescott	0 à 16 mm
Table de chariotage (Lxl)	600 x 420 mm	Dimension de la table	368 x 160 mm
TOUPIE/TENONNEUSE		Hauteur de Mortaisage	140 mm
Puissance moteur (230V - 50Hz)	3000W S1	Course longitudinale	80 mm
Vitesses de rotation	3500 - 5500 - 7000	Course latérale	85 mm
Diamètre de l'arbre	30 mm	Sortie d'aspiration du combiné	3 x ø 100 mm
Filetage de l'arbre	M14	Poids Net	400 Kg
Hauteur de l'arbre	90 mm	Référence pour pièces détachées : Mono	270100 (+ N°/vue éclatée)
Diamètre Maxi de l'outil dans le puit / le capot	140 mm / 200 mm	Gencod :	3700501705608
DÉGAUCHISSEUSE /RABOTEUSE		Colisage (LxlxH) :	1300 x 1130 x 1010 mm
Puissance moteur (230V - 50Hz)	2000W S1	Poids Brut	464 Kg
Vitesse de rotation	4000 T/min	Prix	6145,12€
Diamètre de l'arbre	75 mm	Ecotaxe	2,08€
Dimensions des fers	250 x 30 x 3 mm		
Nombre de fers	3		

FOURNITURES ET ACCESSOIRES

• La machine est livrée avec 1 lame carbure Ø 250 de 24 dents, 1 inciseur Ø 80 de 8 dents, 3 fers de coupe, les presseurs, la butée de délignage, le chariot latéral avec sa règle graduée, les bagues de remplissage et de réglage, les bagues lumière de table, 1 rouleau ponceur (hauteur 120 - grain 100), le guide à barrettes, le guide pour le travail à l'arbre, la règle à tenonner, 1 fixation basculante d'entraîneur, clés et notice d'utilisation.



	LEMAN	€
Fixation basculante d'entraîneur	270001	112,34
Guide à barrettes	250003	141,28
Guide pour travail à l'arbre	250004	194,03



OPTION



OPTION



OPTION

	LEMAN	€
Kit de déplacement	270001	112,34

	LEMAN	€
Mortaiseuse	270010	554,49

	LEMAN	€
Capot de tenonnage	270003	137,31

CONSOMMABLES

BOIS MASSIF

222.250.3024 P. 76

334.250.3048 P. 78

PANNEAUX ET DÉRIVÉS

336.250.3060 P. 87

338TF.250.80 P. 89

356.080.20210 P. 90

357.080.2012 P. 90

LEMAXIMUM P. 242

025.30.302 P. 293

322.500.01 P. 323



ASP302 (MONOPHASE) - ASP302T (TRIPHASE) ASPIRATEUR • 300 L



- Appareil destiné à être relié à une ou plusieurs machines à bois pour l'aspiration de copeaux, de sciure et de poussières de bois.
- Base mécano-soudée montée sur 4 roulettes multidirectionnelles.
- Hélice en acier riveté pour une plus grande résistance à l'usure et ailettes profilées pour optimiser le débit d'air et minimiser le bruit.
- Ventilateur, collecteurs et une colonne mécano-soudée.



Sac de filtration en feutre



Hélice en acier



Sangle à feuillard + attache de maintien du sac

GARANTIE	2
Puissance moteur (230V / 400V - 50Hz)	2200W-S1
Encombrement (LxlxH)	1500 x 730 x 1940 mm
Vitesse de rotation	2950 t/min
Diamètre de l'hélice	305 mm
Diamètre d'entrée du ventilateur	150 mm
Nombre et diamètre de connexion	3 x 100 mm
Longueur du flexible	2 m
Vitesse de l'air	45 m/s
Débit d'air	2864 m3/h
Diamètre des sacs	500 mm
Hauteur du sac de filtration	850 mm
Capacité de récupération	2 x 150 litres
Filtration des sacs	5 microns
Poids Net	47 Kg
Référence pour pièces détachées	
- Mono	091000 (+ N°/vue éclatée)
- Tri	091100 (+ N°/vue éclatée)
Gencod	
- Mono	3661589071682
- Tri	3661589072542
Colisage (LxlxH)	1170 x 560 x 570 mm
Poids Brut	52 Kg
Prix	600,60€
Ecotaxe	2,08€

FOURNITURES ET ACCESSOIRES

- La machine est livrée avec 2 sacs de filtration en feutre, 2 sacs de récupération en plastique, 2 bouchons obturateurs, 2 m de tuyau flexible, 2 colliers de serrage, 4 sangles à feuillard, 2 poignées et 4 roulettes de déplacement, clés et notice d'utilisation.

	LEMAN	€
Sac de récupération · Plastique · ø 500 x 1250 mm	090101	3,49
Sac de récupération · Coton · ø 500 x 1000 mm	090102	17,87
Sac de filtration · Feutre · ø 500 x 850 mm	090103	17,87
Sangle à feuillard pour sac	090104	6,79
Cartouche de filtration · ø 500 - h = 650 mm	090105	224,87
Collier de serrage · ø 100	090006	5,14
Tuyau flexible en pvc (vendu au mètre) · ø 100mm	090005	17,99
Boîtier de démarrage synchronisé ·	090007	199,17
Adaptateur · ø max 125 à 100 mm - l 130 mm	ADA100.120A	16,70





ASP165 (MONOPHASE) - ASP165T (TRIPHASE) ASPIRATEUR • 165 L



- Haut débit d'air, capacité de récupération élevée
- Unité de ventilation réversible pour pouvoir s'adapter facilement à la configuration des machines et de l'atelier
- Montage simple et rapide
- Hélice et ventilateur en acier mécano-soudé
- Base mécano-soudée montée sur 4 roulettes



Sac de filtration en feutre



Hélice en acier



Sangle à feuillard + attache de maintien du sac

Tension/Fréquence	230 V / 50 Hz (ASP165) 400 V / 50 Hz (ASP165T)
Puissance Moteur	1500 W - S1
Vitesse de Rotation	2800 t/min
Diamètre Hélice	Ø300 mm
Diamètre Entrée Ventilateur	Ø150 mm
Nombre de Connexions	3 Ø100 mm
Longueur du Flexible	2 m
Débit d'Air	2900 m³/h
Diamètre des Sacs	500 mm
Hauteur du Sac de Récupération	1250 mm
Capacité de Récupération	1x165 l
Hauteur du Sac de Filtration	1100 mm
Filtration du Sac	5 µ
Pression Acoustique LpA	83,4 dB(A) à vide
Puissance Acoustique LwA	98,17 dB(A) à vide
Poids Net	45 kg
Poids Brut	48 kg
Encombrement	985 x 560 x 2220 mm
Dimensions Colisage	1050 x 610 x 520 mm
Racine Pièces Détachées	091300 (ASP165) 091400 (ASP165T)
Gencod	3661589102560 (ASP165) 3661589102577 (ASP165T)
Prix	520,30€
Ecotaxe	2,08€

FOURNITURES ET ACCESSOIRES

- La machine est livrée avec un sac de filtration en feutre, un sac de récupération en plastique, 2 sangles à feuillard, 2 bouchons obturateurs, 2 mètres de tuyau flexible, 2 colliers de serrage, 4 roulettes de déplacement et notice d'utilisation.

	LEMAN	€
Sac de récupération · Plastique · ø 500 x 1250 mm	090101	3,49
Sac de filtration · Feutre · ø 500 x 1100 mm	091303	19,85
Sangle à feuillard pour sac	090104	6,79
Collier de serrage · ø 100	090006	5,14
Tuyau flexible en pvc (vendu au mètre) · ø 100mm	090005	17,99
Cartouche de filtration · ø 500 · h = 650 mm	090105	224,87

090101



090006



091303



090005



090105



090104





ASP152 (MONOPHASE) - ASP152T (TRIPHASE) ASPIRATEUR • 150 L



- Appareil destiné à être relié à une ou plusieurs machines à bois pour l'aspiration de copeaux, de sciure et de poussières de bois.
- Base mécano-soudée montée sur 4 roulettes multidirectionnelles.
- Hélice en acier riveté pour une plus grande résistance à l'usure et ailettes profilées pour optimiser le débit d'air et minimiser le bruit.
- Ventilateur et collecteur en acier mécano-soudé.
- Collecteur munis d'attaches métalliques et de bandes caoutchouc pour un serrage des sacs optimum.



Sac de filtration en feutre



Hélice en acier



Sangle à feuillard + attache de maintien du sac

GARANTIE	2
Puissance moteur (230V / 400V - 50Hz)	1500W-S1
Encombrement (LxlxH)	850 x 610 x 1950 mm
Vitesse de rotation	2950 t/min
Diamètre de l'hélice	305 mm
Diamètre d'entrée du ventilateur	125 mm
Nombre et diamètre de connexion	2 x 100 mm
Longueur du flexible	2 m
Vitesse de l'air	30,4 m/s
Débit d'air	1344 m3/h
Diamètre des sacs	500 mm
Hauteur du sac de filtration	850 mm
Capacité de récupération	1 x 150 litres
Filtration des sacs	5 microns
Poids Net	39 Kg
Référence pour pièces détachées	
- Mono	090800 (+ N°/vue éclatée)
- Tri	090900(+ N°/vue éclatée)
Gencod	
- Mono	3661589071675
- tri	3661589072535
Colisage (LxlxH)	920 x 580 x 580 mm
Poids Brut	43 Kg
Prix	448,09€
Ecotaxe	2,08€

FOURNITURES ET ACCESSOIRES

- La machine est livrée avec 1 sac de filtration en feutre, 1 sac de récupération en plastique, 1 bouchon obturateur, 2 m de tuyau flexible, 2 colliers de serrage, 2 sangles à feuillard, 1 poignée et 4 roulettes de déplacement, clés et notice d'utilisation.

	LEMAN	€
Sac de récupération - Plastique - ø 500 x 1250 mm	090101	3,49
Sac de récupération - Coton - ø 500 x 1000 mm	090102	17,87
Sac de filtration - Feutre - ø 500 x 850 mm	090103	17,87
Sangle à feuillard pour sac	090104	6,79
Cartouche de filtration - ø 500 - h = 650 mm	090105	224,87
Collier de serrage - ø 100	090006	5,14
Tuyau flexible en pvc (vendu au mètre) - ø 100mm	090005	17,99
Boîtier de démarrage synchronise -	090007	199,17
Adaptateur - ø max 125 à 100 mm - l 130 mm	ADA100.120A	16,70





LOASP060 (MONOPHASE) ASPIRATEUR • 60 L



- Base mécano-soudée montée sur 4 roulettes dont 2 multidirectionnelles.
- Large poignée pour un déplacement aisé.
- Buse d'aspiration au sol fixée sur la base.
- Puissant moteur asynchrone de 750W, endurant et silencieux.
- Hélice en acier riveté pour une plus grande résistance à l'usure et ailettes profilées pour optimiser le débit d'air et minimiser le bruit.
- Corps de ventilateur, collecteur et montants en acier mécanosoudé.
- Sac de filtration en feutre et sac de récupération en plastique.
- Connexion au ventilateur Ø100mm.
- Tuyau de connexion très résistant (double couche de PVC avec spire en polyamide), mais souple et très maniable.



Sac de filtration en feutre

GARANTIE	2
Puissance moteur (230 V - 50Hz)	750W-51
Encombrement (LxlxH)	870 x 380 x 1520 mm
Vitesse de rotation	2950 t/min
Diamètre de l'hélice	230 mm
Diamètre d'entrée du ventilateur	100 mm
Nombre et ø de connexion	1 x 100 mm
Longueur du flexible	0,75 m
Vitesse de l'air	14,15 m3/min - 500 CFM
Diamètre des sacs	370 mm
Hauteur du sac de filtration	650 mm
Capacité de récupération	1 x 60 litres
Filtration des sacs	5 microns
Poids Net	24 Kg
Référence pour pièces détachées	090000 (+ N°/vue éclatée)
Gencod	3700501700092
Colisage (LxlxH)	760 x 450 x 460 mm
Poids Brut	27 Kg
Prix	345,35€
Ecotaxe	2,08€

FOURNITURES ET ACCESSOIRES

• La machine est livrée avec 1 sac de filtration en feutre et 1 sac de récupération en plastique, 1 buse d'aspiration au sol, 0,75 m de flexible, 2 colliers de serrage, 2 sangles à feuillard, clés et notice d'utilisation.

	LEMAN	€
SAC DE RÉCUPÉRATION · Plastique · ø 370 x 750 mm	090001	2,76
SAC DE RÉCUPÉRATION · Coton · ø 370 x 640 mm	090002	11,56
SAC DE FILTRATION · Feutre · ø 370 x 650 mm	090003	11,44
SANGLE À FEUILLARD ·	090004	5,51
TUYAU FLEXIBLE EN PVC (VENDU AU MÈTRE · ø 100mm)	090005	17,99
COLLIER DE SERRAGE · ø 100	090006	5,14





LOASP050 ASPIRATEUR À COPEAUX • 50 L



- Aspirateur polyvalent pour copeaux et sciures, sur chantier ou en atelier.
- Cuve en acier de 50l, bloc moteur avec poignée de transport
- Set d'adaptateurs permettant de se connecter sur tout type de machine portable
- Sac de filtration 0,5µ en papier



Poignée de transport



Fournitures Standards

Tension/Fréquence	230 V / 50 Hz
Puissance Moteur	1200 W - S1
Classe de Protection	Classe I
Indice de Protection	IPX0
Diamètre Hélice	Ø130 mm
Diamètre Entrée Cuve	Ø100 mm
Adaptateurs de Connexion	Ø100/40/37/35/32 mm
Longueur du Flexible	2 m
Dépression	2,5 kPa
Débit d'Air	183 m ³ /h
Capacité de Récupération	50 l (cuve)
Surface de Filtration	0,3 m ²
Filtration du Sac	0,5 µ
Cable	H05VV-F 3x0,75mm ²
Longueur de Cable	1,9m
Pression Acoustique LpA	79,3 dB(A) à vide
Puissance Acoustique LwA	92,3 dB(A) à vide
Poids Net	10,5 kg
Poids Brut	12,4 kg
Hauteur de l'Appareil	670 mm
Encombrement	400 x 400 x 660 mm
Dimensions Colisage	420 x 420 x 715 mm
Racine Pièces Détachées	091200
Code-barres	3661589102584
Prix	163,90€
Ecotaxe	2,08€

FOURNITURES ET ACCESSOIRES

- La machine est livrée avec 2 sacs filtres en papier, 2 mètres de tuyau flexible, 2 colliers de serrage, un filtre plissé, adaptateurs et notice d'utilisation.

	LEMAN	€
Sac Papier de Rechange	091201	13,34
Filtre Plissé de Rechange	091202	26,67
Set d'Adaptateurs	091203	16,70
Tuyau Flexible PVC (au M)	090005	17,99
Collier de Serrage Ø100mm	090006	5,14

091201



090006



091202



090005



091203



TAB120 (MONOPHASE)

TOUR À BOIS ÉLECTRONIQUE • 1200 MM



- Piètement en fonte d'acier, stable et esthétique.
- Banc en fonte d'acier, percé pour pouvoir être fixé sur le piètement (ou sur un établi).
- Variateur électronique avec affichage digital de la vitesse de rotation. Elle peut varier selon le positionnement de la courroie.
- Vitesse lente 0 à 1200 T/min ou rapide de 1200 à 3200 T/min.
- Support d'outil en fonte d'acier, orientable dans toutes les positions grâce à son bras articulé en fonte. Positionnement sur le banc par serrage excentrique.
- Les poupées sont en fonte d'acier, elles sont percées de façon à pouvoir déloger les outils (chasse pièce fourni) et permettre le passage d'une mèche ou d'un fleuret de perçage.
- Diviseur multi - positions



Variateur électronique



Broche d'entraînement CM2 fileté M33 x 3,5



Rallonge et support d'outil extérieur

GARANTIE	2
Puissance moteur (230 V - 50Hz)	1500W-S1
Encombrement (LxlxH)	1900 x 420 x 1180 mm
Hauteur du banc	900 mm
Vitesse de rotation	
- Vitesse lente	De 0 à 1200 t/min
- Vitesse rapide	De 1200 à 3200 t/min
Distance entre pointes	1200 mm
Diamètre au dessus du banc	450 mm
Diamètre au dessus de la rallonge	750 mm
Longueur du support d'outil	300 mm
Broche d'entraînement	M33 x 3,5
Cône de la poupée fixe	CM2
Cône de la poupée mobile	CM2
Perçage de la poupée mobile	ø 10 mm
Poids Net	190 Kg
Référence pour pièces détachées	150200 (+ N°/vue éclatée)
Gencod	3700501704816
Colisage (LxlxH)	1720 x 550 x 560 mm
Poids Brut	234 Kg
Prix	3070,38€
Ecotaxe	2,08€

FOURNITURES ET ACCESSOIRES

- La machine est livrée avec le piètement, l'ensemble du support outil, la rallonge pour le tournage extérieur, 1 plateau tournant de 150mm, 1 pointe à griffes, 1 contre-pointe tournante, 1 goupille d'indexation, 1 chasse pièce, clés et notice d'utilisation.



	LEMAN	€
Buse d'aspiration réglable	BAS100	60,88
Copieur 1010 mm	COP120	321,93



	LEMAN	€
Lunette de tournage	150200.LUN	83,09

CONSOMMABLES

PAGE 432

TAB110 (MONOPHASE) TOUR À BOIS • 1100 MM



- Piètement en fonte d'acier, stable et esthétique.
- Banc en fonte d'acier, percé pour pouvoir être fixé sur le piètement (ou sur un établi).
- Le changement de vitesse se fait automatiquement, par palier, sans toucher à la courroie.
- Support d'outil de 300 mm en fonte d'acier, orientable dans toutes les positions grâce à son bras articulé en fonte. Positionnement sur le banc par serrage excentrique.
- Poupée fixe et poupée mobile percées à 10 mm pour pouvoir déloger les outils (chasse pièce fourni) et pour le passage d'une mèche ou d'un fleuret de perçage.



Rotation de la tête jusqu'à 180°



Broche d'entraînement
CM2 fileté M33 x 3,5



Poupée fixe et mobile percée
à 10 mm

GARANTIE	2
Puissance moteur (230 V - 50Hz)	1100W-S1
Encombrement (LxlxH)	1700 x 420 x 1180 mm
Hauteur du banc	890 mm
Nombre de vitesses	10
Vitesse de rotation (variable)	De 500 à 2000 t/min
Distance entre pointes	1100 mm
Diamètre au dessus du banc	400 mm
Longueur du support d'outil	300 mm
Positionnement de la tête	0°- 60°- 90°-120°- 180°
Broche d'entraînement	M33 x 3,5
Cône de la poupée fixe	CM2
Cône de la poupée mobile	CM2
Perçage de la poupée mobile	ø 10 mm
Poids Net	130 Kg
Référence pour pièces détachées	150100(+ N°/vue éclatée)
Gencod	3700501700214
Colisage (LxlxH)	1620 x 450 x 520 mm
Poids Brut	140Kg
Prix	1164,63€
Ecotaxe	2,08€

FOURNITURES ET ACCESSOIRES

- La machine est livrée avec le piètement, l'ensemble du support d'outil, 1 plateau de 150 mm, 1 pointe à griffes, 1 contre-pointe tournante, 1 chasse pièce, clés et notice d'utilisation.



OPTION

	LEMAN	€
Buse d'aspiration réglable	BAS100	60,88
Copieur 1010 mm	COP110	267,63



	LEMAN	€
Lunette de tournage	150100.LUN	74,71

CONSOMMABLES

PAGE 432

TAB085 (MONOPHASE) TOUR À BOIS • 850 MM



- Piètement en acier, stable et rigide.
- Banc en fonte d'acier avec une extension positionnée derrière la tête, percé pour pouvoir être fixé sur le piètement.
- Le changement de vitesse se fait automatiquement, par palier, sans toucher à la courroie.
- Tête en fonte d'acier avec carrossage métallique, positionnable à 90° pour usiner les pièces de grand diamètre hors du banc et à 180° pour avoir une position de tournage plus confortable en utilisant le support d'outil sur l'extension de banc.
- Support d'outil de 300 mm en fonte d'acier, orientable dans toutes les positions grâce à son bras articulé en fonte. Positionnement sur le banc par serrage excentrique.
- Poupée fixe et poupée mobile percées à 10 mm pour pouvoir déloger les outils (chasse pièce fourni) et pour le passage d'une mèche ou d'un fleuret de perçage.



Moteur avec courroie

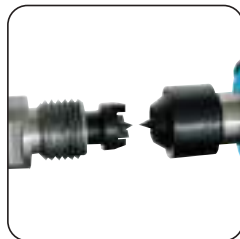

Alignement des pointes CM2 et broche d'entraînement fileté M33 x 3,5 mm



10 Vitesses variables de 500 à 2000 tr/min

GARANTIE	2
Puissance moteur (230 V - 50Hz)	450W-51
Encombrement (LxlxH)	1520 x 480 x 1130 mm
Hauteur du banc	880 mm
Nombre de vitesses	10
Vitesse de rotation (variable)	De 500 à 2000 t/min
Distance entre pointes	850 mm
Diamètre au dessus du banc	305 mm
Longueur du support d'outil	300 mm
Positionnement de la tête	0°- 60°- 90°-120°-180°
Broche d'entraînement	M33 x 3,5
Cône de la poupée fixe	CM2
Cône de la poupée mobile	CM2
Perçage de la poupée mobile	ø 10 mm
Poids Net	75 Kg
Référence pour pièces détachées	150000 (+ N°/vue éclatée)
Gencod	3700501700207
Colisage (LxlxH)	1380 x 330 x 370 mm
Poids Brut	79 Kg
Prix	721,88€
Ecotaxe	2,08€

FOURNITURES ET ACCESSOIRES

- La machine est livrée avec le piètement, l'ensemble du support d'outil, 1 plateau de 150 mm, 1 pointe à griffes, 1 contre-pointe tournante, 1 chasse pièce, clés et notice d'utilisation.



OPTION



CONSOMMABLES

PAGE 432

	LEMAN	€
Buse d'aspiration réglable	BAS100	60,88
Copieur 850 mm	COP085	254,42

	LEMAN	€
Lunette de tournage	150000.LUN	62,29

TAB050 (MONOPHASE)

TOUR À BOIS ÉLECTRONIQUE • 510 MM



- Banc en fonte d'acier, percé pour être fixé sur un piétement ou sur un établi.
- Moteur DC à courant continu délivrant une vitesse constante et offrant un excellent rendement.
- 3 plages de vitesses mécaniques par changement de la position de la courroie, puis réglage de la vitesse par variateur électronique avec compteur digital.
- Tête en fonte d'acier, broche d'entraînement M33x3,5 avec indexation à 24 positions.
- Broche d'entraînement avec 2 sens de rotation, la rotation inversée permettant notamment une finition de ponçage de très grande qualité.
- Support d'outil orientable de 200 mm en fonte d'acier, positionnement sur le banc par serrage excentrique.
- Poupée mobile en fonte d'acier positionnable sur le banc par serrage excentrique.
- Porte-accessoires fixé sur le banc.



Indexation 24 positions

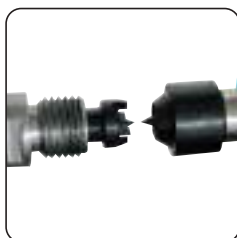

Tête en fonte d'acier, broche d'entraînement M33x3,5



Variateur électronique avec affichage digital

GARANTIE	2
Puissance moteur (230V - 50Hz)	750 W - S1
Encombrement (LxlxH)	1050 x 310 x 445 mm
Nombre de vitesses	3
Vitesse de rotation (variable)	250-750 + 550-1650 + 1300-3850 t/min
Distance entre pointes	510 mm
Diamètre au dessus du banc	ø 320 mm
Longueur du support d'outil	200 mm
Broche d'entraînement	M33x3,5
Cône de la poupée fixe	CM2
Cône de la poupée mobile	CM2
Perçage de la poupée mobile	ø 10mm
Poids Net	52 Kg
Référence pour pièces détachées	150600 (+ N°/vue éclatée)
Gencod	3661589084187
Colisage (LxlxH)	985 x 525 x 315 mm
Poids Brut	59 Kg
Prix	992,15€
Ecotaxe	2,08€

FOURNITURES ET ACCESSOIRES

- La machine est livrée avec le plateau tournant Ø76 mm, l'ensemble du support d'outil de 200 mm, 1 pointe à griffes, 1 contre-pointe tournante, 1 chasse-pièce, 1 porte-accessoires, clés et notice d'utilisation.



OPTION

	LEMAN	€
Rallonge de banc 1120 mm	150304	162,07
Extension du piétement	150302	96,92
Piètement	150301	152,42

CONSOMMABLES

PAGE 432

TAB040 (MONOPHASE) TOUR À BOIS • 406 MM



- Poupée fixe, mobile et banc en fonte d'acier avec usinage très soigné.
- La base du banc est percée pour pouvoir être fixée sur le piètement ou sur un établi.
- Porte-accessoires positionné sur le banc.
- Poupée mobile en CM2 positionnable sur le banc par son serrage excentrique. Elle est équipée d'une contre-pointe tournante, réglable par une manivelle.
- Les poupées sont percées à un Ø 10 mm de façon à pouvoir déloger les outils (chasse-pièce fourni) et permettre le passage d'une mèche ou d'un fleuret de perçage.
- Support d'outil en fonte d'acier, orientable dans toutes les positions grâce à sa base articulée. Positionnement sur le banc par serrage excentrique.
- Une rallonge de banc pourra être positionnée de façon à obtenir une distance entre pointes de 1025 mm.



Diviseur 12 positions



Broche d'entraînement
filetée M33 x 3.5mm



6 vitesses mécaniques

GARANTIE	2
Puissance moteur (230V-50Hz)	580W-S1
Encombrement (LxlxH)	990 x 290 x 450 mm
Hauteur du banc	190 mm
Nombre de vitesses	6
Vitesse de rotation	1 - 350 T/min 2 - 670 T/min 3 - 1025 T/min 4 - 1500 T/min 5 - 2225 T/min 6 - 3250 T/min
Distance entre pointes	406 mm
Diamètre au dessus du banc	305 mm
Longueur du support outil	200 mm
POUPÉE FIXE	
Cône de la poupée fixe	CM2
Filetage de la broche d'entraînement	M33 x 3,5 mm
Diviseur	12 positions
POUPÉE MOBILE	
Cône de la poupée mobile	CM2
Course de la contre-pointe tournante	65 mm
Perçage des poupées	ø 10 mm
Poids Net	42 Kg
Référence pour pièces détachées	150300 (+ N°/vue éclatée)
Gencod	3700501706100
Colisage (LxlxH)	850 x 455 x 290 mm
Poids Brut	47 Kg
Prix	628,38€
Ecotaxe	2,08€

FOURNITURES ET ACCESSOIRES

- La machine est livrée avec le piètement, l'ensemble du support d'outil, 1 plateau de 150 mm, 1 pointe à griffes, 1 contre-pointe tournante, 1 chasse pièce, clés et notice d'utilisation.



OPTION

	LEMAN	€
Rallonge de banc 620 mm	150303	128,99
Extension du piètement	150302	96,92
Piètement	150301	152,42

CONSOMMABLES

PAGE 432

AFF251 (MONOPHASE) AFFÛTEUSE À EAU • 250 MM



- Affûteuse à eau qui répond aux attentes des amateurs avertis mais aussi des professionnels pour l'affûtage de leurs outils.
- Cette affûteuse est équipée d'une meule à eau en corindon de qualité supérieure grain 220 et d'un disque de démorfilage composé d'un feutre.
- Support universel en F conçu pour recevoir tous les accessoires tels que dispositif d'affûtage pour couteaux, ciseaux, fers de rabot, gouges etc...
- Positionnement du support en F à la verticale ou à l'horizontale avec molette de réglage de la hauteur.
- Bâti mécano-soudé muni de patins antidérapants pour garantir la stabilité de la machine et limiter les vibrations.
- Interrupteur marche/arrêt avec 2 positions de rotation: permet d'affûter dans le sens du tranchant ou contre le tranchant sans changer le positionnement de l'outil.



Poignée de transport



Interrupteur marche/arrêt avec sélection du sens de rotation



Support universel en F Ø12mm avec molette de réglage

GARANTIE	2
Puissance moteur (230V- 50Hz)	150W-S1
Vitesse de rotation du moteur	1450 T/min
Encombrement (LxlxH)	340 x 265 x 335 mm
Diamètre de la meule	ø 250 mm
Largeur de la meule	50 mm
Alésage de la meule	12 mm / Ecrou M12
Vitesse de rotation de la meule	95 T/min
Diamètre du disque de démorfilage	Ø 200 mm
Largeur du disque	30 mm
Alésage du disque	12,5 mm / Ecrou M8
Diamètre de la tige pour accessoires d'affûtage	ø 12 mm
Longueur du câble d'alimentation	1,8 m
Poids Net	16,1 Kg
Référence pour pièces détachées	350100(+ N°/vue éclatée)
Gencod	3661589065353
Colisage (LxlxH)	380 x 380 x 380 mm
Poids Brut	18 kg
Prix	376,69€
Ecotaxe	2,08€

FOURNITURES ET ACCESSOIRES

- La machine est livrée avec 1 meule ø 250 grain 20, 1 disque de démorfilage ø 200mm, le bac à eau, le gabarit pour mesure d'angle, le dispositif pour les tranchants droits, la pâte à polir, le dispositif d'affûtage et le disque de démorfilage pour gouges, le redresse meule diamanté, le prépare meule et notice d'utilisation.

	LEMAN	€
Meule corindon • 220 grain ø 250	350000.042	42,89
Disque de démorfilage ø 200	350000.009	35,98
Dispositif d'affûtage pour tranchants droits	350000.034	20,44
Redresse meule diamanté	350001	54,09
Pâte à polir	350002	15,97
Gabarit pour mesure des angles	350003	9,61
Dispositif d'affûtage pour gouges	350004	45,65
Disque de démorfilage pour gouges	350005	57,58
Prépare meule	350006	17,38



PON250 (MONOPHASE) COMBINÉ PONCEUR • 250 MM



- Bâti en fonte d'acier, rigide et robuste, avec trous de fixation et patins en caoutchouc.
- Capteur de sciure au niveau de la bande avec une sortie d'aspiration commune avec le disque, ce qui évite de multiplier les branchements.
- Butée d'appui en bout de table de la bande. Elle sert également de table lorsque la bande est à la verticale.
- Manette de détente rapide de la bande.
- Molette de centrage de la bande située à l'arrière.



Guide d'onglet



Bande orientable de 0° à 90°



Table en fonte d'acier, inclinable à 45°

GARANTIE	2
Puissance moteur (230 V - 50Hz)	800 W - S1
Encombrement (LxlxH)	630 x 540 x 470 mm
Dimensions de la table (LxP)	355 x 200 mm
Inclinaison	45° vers le bas
Guide d'onglet	- 60° à +60°
Sortie d'aspiration	ø 62 mm
DISQUE DE PONÇAGE	
Diamètre	250 mm
Fixation	Autocollant / Adhésive
Vitesse de rotation	1400 t/min
BANDE DE PONÇAGE	
Dimensions de la bande (Lxl)	1219 x 150 mm
Vitesse	517 m/min
Inclinaison	0° et 90°
Longueur de la table d'appui	500 mm
Poids Net	54 Kg
Référence pour pièces détachées	190100 (+ N° vue éclatée)
Gencod	3700501700276
Colisage (LxlxH)	Machine: 720 x 410 x 440 mm Piétement: 770 x 80 x 150 mm
Poids brut	56 Kg
Prix	763,27€
Ecotaxe	2,08€

FOURNITURES ET ACCESSOIRES

- La machine est livrée avec le piétement, guide d'onglet, 1 disque grain 80 autocollant, 1 bande grain 80, clés et notice d'utilisation.

CONSOMMABLES

PAGES
347, 361 ET 362

PON306 (MONOPHASE) PONCEUSE À DISQUE • 305 MM



- Bâti en fonte d'acier avec trous de fixation et patins en caoutchouc.
- Sortie d'aspiration Ø52 mm extérieur (45mm intérieur).
- Table en fonte d'aluminium inclinable à 45° vers le bas.
- Guide d'onglet pour le ponçage de pièces biseautées.



Moteur asynchrone



Frein du disque



Table inclinable à 45°

GARANTIE	2
Puissance moteur (230V-50Hz)	900W-51
Encombrement (LxH)	435 x 500 x 400 mm
Dimension totale de la table (LxP)	435 x 210 mm
Inclinaison de la table	45° vers le bas
Guide d'onglet	- 60° à + 60°
Sortie d'aspiration	ø 52 mm
DISQUE DE PONCAGE	
Diamètre	305 mm
Fixation	Autocollant / Adhesive
Vitesse de rotation	1450 T/min
Poids Net	30 kg
Référence pour pièces détachées	190500(+ N°/vue éclatée)
Gencod	3700501706261
Colisage (LxH)	460 x 430 x 420 mm
Poids Brut	33 Kg
Prix	323,75€
Ecotaxe	2,08€

FOURNITURES ET ACCESSOIRES

- La machine est livrée avec le guide d'onglet, 1 disque autocollant grain 80, clés et notice d'utilisation.



LOPON150 (MONOPHASE) COMBINÉ PONCEUR • 150 MM



- Bâti en fonte d'acier alliant robustesse et stabilité. Trous de fixation permettant d'installer la machine sur un piétement ou un établi. Puissant moteur asynchrone de 370W, endurant et silencieux.
- Capteur de sciure au niveau de la bande, sortie d'aspiration Ø67mm commune avec le disque ce qui évite de multiplier les branchements.
- Butée d'appui en bout de table de la bande. Bien dimensionnée, elle permet également de canaliser les sciures vers le capteur.
- Manette de détente rapide de la bande. Elle se sort aisément par l'avant, sans besoin de démonter quoi que ce soit.
- Molette de centrage de la bande située également à l'avant. Table en fonte d'aluminium inclinable jusqu'à 45° vers le bas.
- Guide d'onglet réglable à ±60° pour le ponçage des pièces biseautées.
- Support de bande relevable à 90°, avec possibilité de fixer la table inclinable pour un meilleur confort de travail.



Table en fonte d'aluminium inclinable à 45°

GARANTIE	2
Puissance moteur (230 V - 50 Hz)	370W-S1
Encombrement (LxlxH)	480 x 350 x 325 mm
Dimensions de la table	215 x 146 mm
Inclinaison	45° vers le bas
Guide d'onglet	- 60° à + 60°
Sortie d'aspiration	ø 67 mm
Disque de ponçage. Diamètre	150 mm
Fixation	Autocollant / Adhesive
Vitesse de rotation	2850 t/min
Bande de ponçage. Dimensions de la bande (Lxl)	914 x 100 mm
Vitesse	435 m/min
Inclinaison	0° et 90°
Longueur de la table d'appui	310 mm
Poids Net	16 kg
Référence pour pièces détachées	190000 (+ N° vue éclatée)
Gencod	3700501700269
Colisage (LxlxH)	560 x 315 x 350 mm
Poids Brut	18 Kg
Prix	226,73€
Ecotaxe	2,08€

FOURNITURES ET ACCESSOIRES

- La machine est livrée avec le guide d'onglet, 1 disque grain 80, 1 bande grain 80, clés et notice d'utilisation.



SOR310 (MONOPHASE)
SCIE À ONGLET RADIALE • 305 MM

- Socle en fonte d'aluminium moulé sous pression, percé pour pouvoir fixer la machine sur un établi.
- Table de sciage en fonte d'aluminium, orientable de 45° à droite et à gauche.
- Guide de coupe réglable en longueur suivant les dimensions de la pièce de bois à couper.
- Système de coulissement sur roulements à billes.
- Butée de profondeur de coupe réglable.
- Barre de maintien à l'arrière pour une stabilité parfaite.
- Double laser de visualisation de la coupe alimenté par le secteur.
- Sortie d'aspiration avec sac de récupération des sciures.



Transmission par courroie



Tête avec coulissement radial

 Tête inclinable de 45°
à droite et à gauche

GARANTIE	2		
Puissance moteur (230V - 50HZ)	2000 W (charbons) - S1		
Encombrement (L x l x h)	1020 x 920 x 760 mm		
Vitesse de rotation	4500 T/min		
Diamètre de la lame	305 mm		
Alésage de la lame	30 mm		
Inclinaison de la tête (à droite et à gauche)	45°		
Orientation de la table (gauche - droite)	45°		
Indexation de la table (gauche - droite)	0°et15°,22,5°,30°,45°		
Sortie d'aspiration (avec sac)	ø 40 mm		
Translation de la tête	210 mm		
Orientation de la table / Inclinaison de la tête / Capacités de coupe			
0°	0°	340 x 105 mm	
45°	0°	240 x 105 mm	
0°	45°	240 x 105 mm	45° à gauche, left (-15 mm à droite, right)
45°	45°	240 x 55 mm	45° à gauche, left (-15 mm à droite, right)
Poids Net	22 kg		
Référence pour pièces détachées	030500 (+ N° vue éclatée)		
Gencod	3700501711814		
Colisage (mm)	910 x 575 x 530 mm		
Poids Brut	26 kg		
Prix	557,51€		
Ecotaxe	0,42€		

FOURNITURES ET ACCESSOIRES

- La machine est livrée avec le presseur vertical et horizontal, 1 lame carbure 60 dents, le sac de récupération des sciures, les rallonges de table, le double laser, 1 jeu de charbon supplémentaire, clés et notice d'utilisation.

CONSOMMABLES
BOIS MASSIF
964.305.3032 P. 81
964.305.3060 P. 81
MÉTAL
964.305.80AL P. 104
964.305.96AL P. 104

SOR250 (MONOPHASE)

SCIE À ONGLET RADIALE • 255 MM



- Machine idéale pour les travaux de délignage et de mise à longueur du bois, ses dérivés et du plastique. Permet de réaliser des coupes d'équerre, des coupes biseautées et des coupes composées.
- Socle en fonte d'aluminium moulé sous pression, avec trous de fixation permettant d'installer la machine sur un piétement ou un établi. Table de sciage rotative en fonte d'aluminium, orientable de 47° à droite et à gauche. Indexation par gâchette aux angles les plus courants.
- Extensions de table pour les pièces de grandes dimensions.
- Presseur vertical à vis positionnable à droite ou à gauche de la lame.
- Tête de sciage inclinable de 48° à gauche et 2° à droite. Translation de la tête de sciage (coupe radiale) pour des capacités de coupes accrues, système de coulissement sur roulements à billes.
- Butée de profondeur de coupe réglable : possibilité de faire des rainures.
- Barre de maintien à l'arrière du socle pour une stabilité parfaite.
- Laser de visualisation de coupe alimenté par le secteur.
- Sortie d'aspiration Ø41 mm avec sac de récupération des sciures.
- Poignée et système de blocage de translation de la tête pour le transport.



Tête avec coulissement radial



Table indexée

GARANTIE	2
Puissance moteur (230V - 50HZ)	2000 W (charbons) - S6 (25%)
Encombrement (L x l x h)	720 x 985 x 560 mm
Vitesse de rotation	5000 T/min
Diamètre de la lame	255 mm
Alésage de la lame	30 mm
Inclinaison de la tête (à gauche et à droite)	48° gauche / 2° droite
Orientation de la table (gauche - droite)	47°
Indexation de la table (gauche - droite)	0° et 15°, 22,5°, 31,6°, 45°
Sortie d'aspiration (avec sac)	ø 41 mm
Translation de la tête	220 mm
Orientation de la table Inclinaison de la tête	Capacités de coupe / Kop Kantelbaarheid
0° 0°	305 x 75 mm
45° 0°	210 x 75 mm
0° 45°	305 x 36 mm
45° 45°	210 x 36 mm
Poids Net	14 kg
Référence pour pièces détachées	030600 (+ N° vue éclatée)
Gencod	3661589080950
Colisage (mm)	790 x 480 x 400 mm
Poids Brut	17 kg
Prix	338,10€
Ecotaxe	0,42€

FOURNITURES ET ACCESSOIRES

- La machine est livrée avec le presseur vertical, 1 lame carbure 40 dents, le sac de récupération des sciures, les rallonges de table, le laser, clés et notice d'utilisation.

CONSOMMABLES

BOIS MASSIF

964.255.3024 P. 84

964.255.3040 P. 84

964.255.3060 P. 84

MÉTAL

964.255.30AL P. 104

EST290 (MONOPHASE)
STAND ÉTABLI POUR MACHINES



- Etabli de qualité professionnelle, rigide et parfaitement stable.
- Stand entièrement pliable, équipé d'une roulette pour le déplacement sur le chantier.
- Bras télescopique gradué, équipé d'une servante à rouleau réglable en hauteur, avec possibilité de relever une butée pour le travail en série. L'extensibilité va de 1635 à 2900 mm.
- 3 prises intégrées (norme CE) pour le branchement de diverses machines.
- Étau de serrage multi-positions avec capacité maximum de 350 mm.



Prises



Étau



Lampe

Encombrement (LxlxH)	2900 x 700 x 1030 mm
Charge maxi	150 Kg
Longueur mini (entre butées)	1635 mm
Longueur maxi (entre butées)	2900 mm
Hauteur de travail	820 mm
Longueur des supports machine	505 mm
Diamètre des rouleaux	20 mm
Longueur des rouleaux	110 mm
Poids Net	26,5 Kg
Référence pour pièces détachées	230100 (+ N° vue éclatée)
Gencod	3700501705028
Colisage (LxlxH)	1700 x 300 x 320 mm
Poids Brut	28,5 Kg
Prix	337,75€

FOURNITURES ET ACCESSOIRES

- L'appareil est livré avec les 2 servantes à rouleau et leur butée, l'étau de serrage, la lampe d'appoint et son support, un jeu de 2 supports de fixation, la notice d'utilisation.

	LEMAN	€
Etau	230100.011	67,98
Support de fixation avec mâchoires de serrage	230100.100	22,21



SAC407 (MONOPHASE)

SCIE À CHANTOURNER AVEC PÉDALE • 400 MM



- Bâti en fonte d'acier, rigide et robuste, avec trous de fixation.
- Variateur de vitesse électronique permettant d'adapter la coupe au matériau.
- Souffleur flexible orientable et sortie d'aspiration Ø 35 sous la table.
- Boîtier de rangement pour les lames et le petit outillage.
- Levier de réglage rapide de la tension de la lame.
- Cache de protection et presseur de bois.



Table en fonte d'aluminium inclinable à 45°



Flexible avec mandrin Ø 3 mm pour micro outillage



Commande de marche/arrêt par pédale

GARANTIE	2
Puissance moteur (230 V - 50Hz)	90 W (charbons) - S1
Encombrement (LxlxH)	640 x 335 x 390 mm
Mise en marche	Interrupteur et commande à pédale
Variateur	Electronique
Vitesse de coupe	550 à 1600 cps/min
Longueur des lames (avec ergots)	127 mm
Dimensions de la table (lxP)	254 x 414 mm
Inclinaison à gauche	45°
Profondeur de coupe	400 mm
Hauteur de coupe	52 mm (20 mm à 45°)
Flexible	1050 mm
Vitesse de rotation du flexible	1650 à 4800 t/min
Pince de serrage	Ø 3,2 mm
Sortie d'aspiration	Ø 35 mm
Puissance de la lampe	LED : 1 W
Alimentation de la lampe	2 piles alcalines R3 AAA (non fournies)
Poids Net	11,7 Kg
Référence pour pièces détachées	130300 (+ N° vue éclatée)
Gencod	3700501708784
Colisage (LxlxH)	660 x 325 x 400 mm
Poids Brut	13,5 Kg
Prix	258,38€
Ecotaxe	2,08€

FOURNITURES ET ACCESSOIRES

- La machine est livrée avec le guide d'onglet, la lampe, le souffleur, le presseur, le cache de protection, le flexible micro outillage, 1 lame de scie à ergots, 2 adaptateurs pour lames sans ergot, un adaptateur d'aspiration conique (Ø 35 à 24 mm intérieur), clés et notice d'utilisation.

CONSUMMABLES

PAGES
137 ET 138



info@leman-sa.com

MACHINES BÂTIMENT

PONCEUSES MURS ET PLAFONDS	P. 510
ASPIRATEURS	P. 514
MALAXEURS	P. 522
CAROTTEUSE	P. 524
SURFACEUSE À BÉTON	P. 525
SCIE CARRELAGE	P. 526
CHAUFFAGE - ÉCLAIRAGE	P. 527



POG225 (MONOPHASE)

PONCEUSE MUR ET PLAFOND • 225 MM



KIT225255 (MONOPHASE)

KIT ASPIRATEUR & PONCEUSE MUR ET PLAFOND • 225 MM



Prix	1617€
Ecotaxe	1,25€

- Carter équipé d'une brosse pour les poussières avec une partie détachable pour les angles.
- Moteur à démarrage progressif et puissant.
- Fixation immédiate du disque sur double face velcro.
- Flexible d'aspiration (4m) à baïonnette équipé d'un adaptateur Ø58/35mm pour le branchement sur un aspirateur.
- Support d'assise et de protection du flexible d'aspiration.



Tête articulée



Partie détachable du plateau pour les angles



Fixation du disque sur pad double face velcro

GARANTIE	2
Puissance moteur (230 V - 50 Hz)	550W
Longueur du bras	1540 mm
Vitesse de rotation à vide	650-1600 Tr/min
Vitesse de rotation en charge	280-950 Tr/min
Diamètre de ponçage	ø 225 mm
Sortie d'aspiration	ø 35 mm
Fixation du disque	Velcro
Pression acoustique	91 dB(A)
Puissance acoustique	102 dB(A)
Vibration main-bras	3,2m/s ²
Classe de protection	II
Poids Net	4,7 kg
Référence pour pièces détachées	225 (+ N° vue éclatée)
Colisage (lxLxH)	1530 x 278 x 305 mm
Gencod	3661589025166
Poids Brut	9,8 Kg
Prix	966,16€
Ecotaxe	0,42€

FOURNITURES ET ACCESSOIRES

- La machine est livrée avec un flexible d'aspiration (ABR003), 5 disques de ponçage GR80, une housse de transport, une poignée de transport (ABR001), un Pad double face (ABR002), clés et notice d'utilisation.



	LEMAN	€
Poignée de transport	ABR001	48,77
Pad double face 210 mm	ABR002	40,94
Flexible à baïonnette 4 m - ø42/35mm	ABR003	45,03
Adaptateur Aspirateur ø58/42mm rotation libre	ABR010	17,64

CONSOMMABLES

PAGES
374 ET 375

LOPOG226 (MONOPHASE)

PONCEUSE MUR ET PLAFOND • 225 MM

750W

4,7 Kg



KIT226306 (MONOPHASE)

KIT ASPIRATEUR & PONCEUSE MUR ET PLAFOND • 225 MM

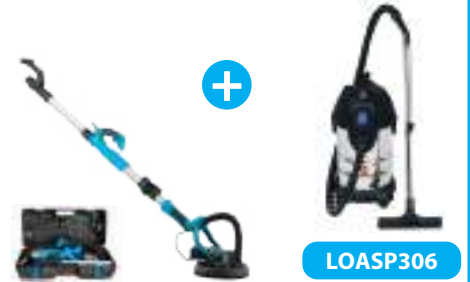

Prix 464,08€
Ecotaxe 1,25€

LOASP306

- Moteur situé sur la tête de ponçage, transmission directe sur le plateau.
- Démarrage progressif avec variateur électronique permettant d'adapter la vitesse de rotation à votre travail.
- Bras repliable facilement et rapidement, sans outil, pour faciliter le transport et le stockage de votre appareil.
- Tête articulée équipée de LED 10W pour un éclairage efficace de la surface de travail, partie détachable pour le ponçage dans les angles.
- Fixation du disque de ponçage par velcro, directement sur le plateau.
- Poignée frontale et poignée principale avec revêtement «Soft Grip», bras télescopique pour adapter la prise de la poignée arrière à votre position de travail. Flexible d'aspiration (4m) à clips équipé d'un adaptateur à rotation libre pour le branchement sur nos aspirateurs ASP255 et LOASP306.
- Démarrage à la gâchette avec bouton de verrouillage pour un travail en continu.



Eclairage LED sur la tête de ponçage.



Tête articulée.

GARANTIE	2
Puissance moteur (230V - 50Hz)	750W
Longueur du bras	1200 à 1800 mm
Vitesse de rotation à vide (t/min)	800-1700 t/min
Diamètre de ponçage	ø225 mm
Sortie d'aspiration	ø38 mm
Fixation du disque	Velcro
Pression acoustique	88dB (A)
Puissance acoustique	99 dB (A)
Vibration main-bras	3,71 m/s ²
Classe de protection	II
Poids Net	4,7 Kg
Référence pour pièces détachées	600600 (+ N°/vue éclatée)
Gencod	366189084637
Colisage (LxlxH)	735 x 345 x 260 mm
Poids Brut	10,9 Kg
Prix	323,40€
Ecotaxe	0,42€

FOURNITURES ET ACCESSOIRES

- La machine est livrée avec le bras télescopique, le flexible d'aspiration, l'adaptateur pour aspirateur (ABR008), 6 disques de ponçage (grains 80, 100, 120, 150, 180, 240), la valise de transport, une paire de charbons de rechange, clés et notice d'utilisation.



600600.003

LEMAN €

Plateau de ponçage velcro 600600.003 40,94

CONSOMMABLES

PAGES
374 ET 375

LOPOG224 (MONOPHASE)

PONCEUSE MUR ET PLAFOND • 225 MM

620W

4,7 Kg



KIT224306 (MONOPHASE)

KIT PONCEUSE MUR ET PLAFOND & ASPIRATEUR



Prix	426,20€
Ecotaxe	1,25€

- Moteur situé sur le bras principal assurant maniabilité et confort d'utilisation, transmission par arbre flexible.
- Démarrage progressif avec variateur électronique permettant d'adapter la vitesse de rotation à votre travail.
- Bras démontable facilement et rapidement, sans outil, pour faciliter le transport et le stockage de votre appareil. Tête articulée, plateau de ponçage muni d'un pad velcro double face. Poignée frontale ergonomique, articulée, et réglable sur l'avant du bras.
- Démarrage par commutateur avec bouton de verrouillage pour un travail en continu.
- Flexible d'aspiration (4m) à baïonnette équipé d'un adaptateur à rotation libre pour le branchement sur nos aspirateurs ASP255 et LOASP306.



Tête articulée



Bras démontable sans outil



Fixation du disque sur pad double face velcro

GARANTIE	2
Puissance moteur (230 V - 50 Hz)	620 W
Longueur du bras	1480 mm
Vitesse de rotation à vide	1000 - 2000 t/min
Diamètre de ponçage	225 mm
Fixation du disque	velcro
Pression acoustique	91 dB (A)
Puissance acoustique	102 dB (A)
Vibration main-bras	2,8 m/s ²
Classe de protection	II
Poids Net	4,7 Kg
Référence pour pièces détachées	225E (+ N° vue éclatée)
Collisage (lxLxH)	860 x 300 x 270
Gencod	3661589046710
Poids Brut	7,3 Kg
Prix	282,40€
Ecotaxe	0,42€

FOURNITURES ET ACCESSOIRES

- La machine est livrée avec un flexible d'aspiration (ABR003L), 5 disques de ponçage (grains 60, 100, 240), une housse de transport, une poignée de transport, un Pad double face, un adaptateur aspirateur (ABR010), clés et notice d'utilisation.



ABR001L



ABR002L



ABR003L



ABR010

	LEMAN	€
Pad double face 210 mm	ABR002L	40,94
Flexible à baïonnette 4 m - ø42/35mm	ABR003L	45,03
Poignée	ABR001L	22,64
Adaptateur aspirateur ø58/42mm rotation libre	ABR010	17,64

CONSOMMABLES

PAGES
374 ET 375

LOPOM226 (MONOPHASE)

PONCEUSE MURALE • 225 MM



- Système d'aspiration intégré pour pouvoir utiliser la machine sans aspirateur, flexible d'aspiration (2m) à clips et sac de récupération des poussières lavable avec bandoulière.
- Démarrage progressif avec variateur électronique permettant d'adapter la vitesse de rotation à votre travail.
- Démarrage à la gâchette avec bouton de verrouillage pour un travail en continu.
- Tête de ponçage profilée pour pouvoir poncer dans les angles.
- Fixation du disque de ponçage par velcro, directement sur le plateau.
- Poignée principale avec revêtement « Soft Grip », poignée latérale auxiliaire positionnable à droite ou à gauche de l'appareil.



Tête de ponçage profilée pour les angles



Sac de récupération des poussières 25L (lavable) avec bandoulière



Bouton de verrouillage et variateur de vitesse

GARANTIE	2
Puissance moteur (230 V - 50 Hz)	900W
Vitesse de rotation à vide	1000-2000 t/min
Support disque	Velcro
Diamètre pad	ø 215 mm
Diamètre de ponçage	ø 225 mm
Sortie d'aspiration	ø 35 mm
Type d'abrasifs	Velcro
Pression acoustique	82 dB(A), K=3dB(A)
Puissance acoustique	93 dB(A), K=3dB(A)
Vibration main-bras	4,64m/s ² , K=1,5m/s ²
Classe de protection	II
Poids Net	2,6 kg
Référence pour pièces détachées	600200 (+ N° vue éclatée)
Colisage (LxLxH)	300 x 270 x 260 mm
Gencod	3661589093073
Poids Brut	4 Kg
Prix	144,38€
Ecotaxe	0,42€

FOURNITURES ET ACCESSOIRES

- La machine est livrée avec une poignée auxiliaire, un sac de récupération des poussières, un flexible d'aspiration, 6 disques de ponçage (grains 80,100,120,150, 180, 240), une paire de charbons de rechange, clé et notice d'utilisation.



600204



600203



600201

	LEMAN	€
Sac de récupération des poussières 25L (lavable)	600201	24,48
Plateau de ponçage velcro Ø 215	600204	40,94
Flexible d'aspiration 2m ø38/32 mm	600203	14,69

CONSOMMABLES

PAGES
374 ET 375



ASP255 (MONOPHASE)

ASPIRATEUR "POLYPROPYLÈNE" "SYNCHRONISÉ" • 25 L

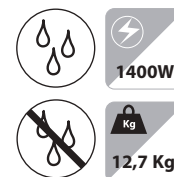

- Grande puissance d'aspiration permanente.
- Surface importante du filtre 8600cm².
- Variateur de vitesse en continu.
- Lampe témoin du filtre.
- Cuve en matière synthétique spéciale extrêmement robuste et anti-chocs résistant à toutes les corrosions.
- Moteur à double flux pour un refroidissement optimal. Deux circuits d'air séparés pour le refroidissement et l'aspiration.
- Détecteurs du niveau de l'eau et arrêt par palpeurs.



Deux cassettes à filtre en polyester classe M



Décolmatage automatique et électromagnétique des filtres par impulsion



Synchronisation avec machine électroportative

GARANTIE	2
Puissance moteur (230 V - 50 Hz)	1400 W
Débit d'air	73 l / sec
Dépression	270 mBar
Capacité utile	25 L
Longueur du câble	8 m
Matériel de la cuve	Synthétique spécial
Dimensions	400 x 400 x 560
Poids Net	12,7 Kg
Référence pour pièces détachées	400 (+ N° vue éclatée)
Niveau de bruit	69,5dB
Diamètre d'accessoires	ø 35 mm intérieur
Gencod	3661589025326
Colisage (lxLxH)	587 x 402 x 574 mm
Poids Brut	15,5 kg
Prix	729,49€
Ecotaxe	0,83€

FOURNITURES ET ACCESSOIRES

• La machine est livrée avec 1 jeu de 2 cassettes à filtre plissé 8600 cm² (Classe M) (ABR401), 1 tuyau flexible d'aspiration ø 45 - 35 mm de 5 m (ABR402), 1 adaptateur caoutchouc conique (ø 35) (ABR403) et notice d'utilisation.



	LEMAN	€
Jeu de 2 cassettes à filtre plissé 8600 cm ² (Classe M)	ABR401	175,43
Tuyau flexible d'aspiration ø45 - 35mm de 5m	ABR402	110,32
Adaptateur caoutchouc conique (ø 35)	ABR403	41,30
Filtre sac en papier (5 pcs)	ABR404	57,03
2 tubes en acier inoxydable 480 mm (ø 35)	ABR405	90,41
Poignée coudée (ø 35 mm)	ABR406	34,08
Suceur sol nu 370mm	ABR407	39,71
Balais brosse (insert) 370mm	ABR408	53,36
Suceur plat	ABR409	7,16





LOASP306 (MONOPHASE)

ASPIRATEUR "INOX" EAU ET POUSSIÈRE DÉCOLMATAGE MANUEL • 30 L

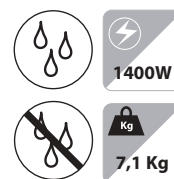

- Aspirateur eau et poussière à usage domestique ou artisanal, idéal pour la maison, l'atelier, le garage, le magasin, le chantier.
- Cuve en acier inoxydable, légère et résistante à la corrosion.
- Flotteur de sécurité permettant l'arrêt du moteur lorsque la cuve atteint son niveau maximum de remplissage.
- Base équipée de 4 roulettes dont 2 multidirectionnelles avec emplacements de rangement des accessoires.
- Poignée de transport et enrouleur de câble situés sur le couvercle.
- Tube en acier chromé télescopique, solide et fonctionnel.
- Prise synchronisée pour le branchement de vos appareils électroportatifs, y compris les ponceuses murs et plafonds.
- Décolmatage manuel du filtre sec par la fonction « Push & Clean » : permet de nettoyer le filtre sans avoir à éteindre ou à ouvrir l'appareil.



Décolmatage manuel du filtre



Prise de synchronisation pour machine électroportative
MAXI 1800W

Garantie	2
Puissance moteur (230V - 50HZ)	1400W
Débit d'air	45 l/s- 162 m3/h
Dépression	20kPa
Capacité totale	30 L
Capacité utile pour liquides	23 L
Longueur du câble	7,5 m
Matériel de la cuve	Inox
Type décolmatage du filtre	Push&Clean
Classe de poussières / zone	L
Dimensions	420 x 325 x 695 mm
Prise électrique synchronisée	1800W
Niveau de bruit	79 dB(A), Incertitude K=3dB(A)
Indice de protection	IPX4
Diamètre d'accessoires	35 mm
Poids Net	7,1 Kg
Référence pour pièces détachées	501300(+ N°vue éclatée)
Gencod	3661589076632
Colisage (LxlxH)	426 x 370 x 730 mm
Poids Brut	9,8 kg
Prix	176,14€
Ecotaxe	0,83€

FOURNITURES ET ACCESSOIRES

- La machine est livrée avec 1 tuyau flexible d'aspiration (ABR331), 1 tube télescopique métallique (ABR303), 1 filtre cartouche HEPA (ABR334), 1 suceur plat droit (ABR336), 1 suceur mixte (ABR332), 1 brosse ronde (ABR335), 1 adaptateur conique (ABR337), 1 sac papier (ABR333) et notice d'utilisation.



	LEMAN	€
Tube métal télescopique (ø 35)	ABR303	19,03
Flexible	ABR331	9,79
Suceur mixte eau et poussière	ABR332	9,42
Sac papier (Lot de 5 pièces)	ABR333	23,44
Filtre cartouche lavable HEPA (CL L)	ABR334	18,17
Brosse ronde	ABR335	6,00
Suceur plat	ABR336	3,67
Adaptateur conique	ABR337	6,00
Filtre éponge	ABR338	4,34





ASP701 (MONOPHASE) ASPIRATEUR INDUSTRIEL "INOX" • 70 LITRES

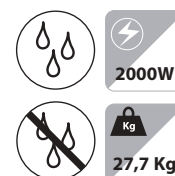

- Aspiration en bi-moteur puissant pour un travail en continu.
- Coupure mécanique (flotteur) du niveau d'eau et évitant l'endommagement des moteurs.
- Cuve en acier inoxydable légère et résistante à la corrosion.
- Tuyau de vidange.
- Chariot de transport.



Filter permanent polyester



Deux moteurs montés en parallèle à refroidissement by-pass



Cuve basculante en inox

GARANTIE	2
Puissance Moteur (230 V - 50 Hz)	2000 W
Débit d'air	106 l/sec / 382 m3/h
Dépression	200 mBar - 20 Kpa
Capacité totale	70 L
Capacité utile liquide	35 L
Longueur du câble	7,2 m
Matériel de la cuve	Acier Inoxydable
Dimensions	600 x 500 x 1030 mm
Poids Net	27,7 Kg
Référence pour pièces détachées	500 (+ N° vue éclatée)
Niveau de bruit	80 dB
Diamètre d'accessoires	ø 38 mm intérieure
Gencod	3661589051486
Colisage (LxlxH)	630 x 620 x 1080 mm
Poids Brut	30 kg
Prix	530,15€
Ecotaxe	0,83€

FOURNITURES ET ACCESSOIRES

- La machine est livrée avec le tuyau flexible d'aspiration 2,5m (LEM501), tubes S en acier chromé 50cm (LEM502), brosse ronde (LEM505), filtre en tissu 4700cm² (LEM507), suceur plat droit (LEM508), suceur à poussières 390 mm (LEM511), suceur à liquides 390 mm (LEM512) et notice d'utilisation.

	LEMAN	€
Tuyau flexible d'aspiration 2,5 m (ø 45 - 38)	LEM501	48,71
Tube S acier chromé (ø38)	LEM502	39,71
Brosse ronde (ø 44)	LEM505	8,16
Filter en tissu 4700 cm ²	LEM507	60,94
Suceur plastique plat droit (ø 44)	LEM508	7,94
Suceur à poussières plastique 390 mm (ø 38)	LEM511	30,72
Suceur à liquides plastique 390 mm (ø 38)	LEM512	33,16
Filter sac papier grand format double épaisseur (10 pces)	ABR517	52,44
Suceur tapis	ABR518	40,51
Filter nylon petit format	ABR514	36,10
Tubes S métalliques 50 cm (2 pcs) (ø 38)	ABR503	43,63
Suceur à poussières métallique 400 mm (ø 38)	ABR511	44,42
Suceur à liquides métallique 400 mm (ø 38)	ABR512	61,62





ASP305 (MONOPHASE) ASPIRATEUR INDUSTRIEL "INOX" • 30 LITRES UTILES



- Coupure mécanique (flotteur) du niveau d'eau pour éviter l'endommagement du moteur.
- Filtre panier en tissu polyester avec 1800 cm² de surface filtrante.
- Cuve en acier inoxydable légère et résistante à la corrosion.
- Chariot de transport



Filtre permanent en polyester



Moteur à refroidissement by-pass



Cuve en inox de 30 litres utiles.
Roues stables et renforcées

GARANTIE	2
Puissance moteur (230 V - 50 Hz)	1200 W
Débit d'air	53 l/sec / 190 m ³ /h
Dépression	200 mBar - 20 Kpa
Capacité totale	30 L
Capacité utile liquide	15 L
Longueur du câble	7,2 m
Matériel de la cuve	Acier inoxydable
Dimensions	430 x 470 x 810 mm
Poids Net	15,8 Kg
Référence pour pièces détachées	500 (+ N° vue éclatée)
Niveau de bruit	75dB
Diamètre d'accessoires	ø 38 mm intérieur
Gencod	3661589051479
Colisage (lxLxH)	520 x 470 x 860 mm
Poids Brut	16 kg
Prix	299,15€
Ecotaxe	0,83€

FOURNITURES ET ACCESSOIRES

- La machine est livrée avec le tuyau flexible d'aspiration 2,5m (LEM501), tubes S en acier chromé 50cm (LEM502), brosse ronde (LEM505), filtre en tissu 1800cm² (LEM506), suceur plat droit (LEM508), suceur à poussières 390 mm (LEM511), suceur à liquides 390 mm (LEM512) et notice d'utilisation.

	LEMAN	€
Tuyau flexible d'aspiration 2,5 m (ø 45 - 38)	LEM501	48,71
Tube S acier chromé (ø38)	LEM502	39,71
Brosse ronde (ø 44)	LEM505	8,16
Filtre en tissu 1800 cm ²	LEM506	36,11
Suceur plastique plat droit (ø 44)	LEM508	7,94
Suceur à poussières plastique 390 mm (ø 38)	LEM511	30,72
Suceur à liquides plastique 390 mm (ø 38)	LEM512	33,16
Filtre sac papier grand format double épaisseur (10 pcs)	ABR517	52,44
Suceur tapis	ABR518	40,51
Filtre nylon petit format	ABR514	36,10
Tubes S métalliques 50 cm (2 pcs) (ø 38)	ABR503	43,63
Suceur à poussières métallique 400 mm (ø 38)	ABR511	44,42
Suceur à liquides métallique 400 mm (ø 38)	ABR512	61,62





LOASP301 (MONOPHASE)
ASPIRATEUR "INOX" SOUFFLEUR
AVEC PRISE SYNCHRONISÉE • 30 L

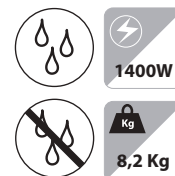

- Aspirateur eau et poussière à usage domestique, idéal pour la maison, l'atelier, le garage, la remise, le chantier ou le magasin.
- Fonction souffleur pour dégager les zones difficilement accessibles (angles, recoins, trous, etc.).
- Bouchon de vidange situé à la base de la cuve.
- Prise synchronisée pour le branchement de vos appareils électroportatifs.

Attention, cet appareil est toutefois déconseillé pour l'aspiration de plâtre et autres poussières fines.



Prise synchronisée

GARANTIE	2
Puissance moteur (230 V - 50Hz)	1400 W
Encombrement (LxlxH)	390 x 380 x 660 mm
Longueur du câble	7,5 m
Prise électrique synchronisée	Maxi 2000 W
Débit d'air	58 L/S
Dépression	20 Kpa
Capacité totale	30 L
Capacité utile liquide	22 L
Diamètre d'accessoires	36
Poids Net	8,2 Kg
Référence pour pièces détachées	300 (+ N° vue éclatée)
Gencod	3700501712484
Colisage (LxlxH)	380 x 390 x 645 mm
Poids Brut	9,6 Kg
Prix	153,04€
Ecotaxe	0,83€

FOURNITURES ET ACCESSOIRES

- La machine est livrée avec 1 tuyau flexible d'aspiration (ABR301), 1 tube télescopique métallique (ABR303), 1 filtre éponge (ABR322), 1 filtre cartouche HEPA (ABR319), 1 sac papier (ABR317), 1 suceur plat droit (ABR307), 1 suceur à poussières (ABR309), 1 adaptateur conique et notice d'utilisation.

	LEMAN	€
Filtre éponge	ABR322	4,34
Roues directionnelles	ABR305	5,75
Suceur plat droite	ABR307	3,67
Tuyau flexible d'aspiration (2,5 m)	ABR301	15,42
Tube métallique télescopique ø 35	ABR303	19,03
Filtre sac papier petit format (Lot de 5 pces)	ABR317	23,44
Filtre cartouche lavable HEPA	ABR319	18,17
Suceur pvc poussières et liquides	ABR309	9,42
Bloque filtre HEPA	ABR321	2,94





LOASP201 (MONOPHASE)
ASPIRATEUR "INOX"
SOUFFLEUR EAU ET POUSSIÈRE • 20 L



- Aspirateur eau et poussière à usage domestique, idéal pour la maison, l'atelier, le garage, la remise ou le magasin.
- Cuve en acier inoxydable, légère et résistante à la corrosion.
- Fonction souffleur pour dégager les zones difficilement accessibles (angles, recoins, trous, etc.).
- Flotteur de sécurité permettant l'arrêt du moteur lorsque la cuve atteint son niveau maximum de remplissage.



Filtre permanent en cartouche lavable

GARANTIE	2
Puissance moteur (230 V - 50Hz)	1250 W
Encombrement (LxlxH)	390 x 380 x 510 mm
Longueur du câble	5 m
Débit d'air	58 L/S
Dépression	20 Kpa
Capacité totale	20 L
Capacité utile liquide	13 L
Diamètre d'accessoires	36
Poids Net	6,3 Kg
Référence pour pièces détachées	300 (+ N° vue éclatée)
Gencod	3700501710398
Colisage (LxlxH)	389 x 382 x 515 mm
Poids Brut	7,5 Kg
Prix	116,37€
Ecotaxe	0,83€

FOURNITURES ET ACCESSOIRES

• La machine est livrée avec 1 tuyau flexible d'aspiration (ABR301), 1 tube plastique en 2 pièces (ABR304), 1 filtre éponge (ABR322), 1 filtre cartouche HEPA (ABR320), 1 sac papier (ABR316), 1 suceur plat (ABR307), 1 suceur à poussières (ABR310) et notice d'utilisation.

	LEMAN	€
Filtre éponge	ABR322	4,34
Roues directionnelles	ABR305	5,75
Suceur plat	ABR307	3,67
Tuyau flexible d'aspiration (1,5 m)	ABR301	15,42
Tube rallonge plastique (50 cm - 2 pces)	ABR304	9,06
Filtre sac papier petit format (Lot de 5 pces)	ABR316	23,44
Filtre cartouche lavable	ABR320	18,72
Suceur pvc poussières et liquides	ABR310	9,73





LOASP151 (MONOPHASE)
ASPIRATEUR "POLYPROPYLÈNE"
SOUFFLEUR EAU ET POUSSIÈRE • 15 L

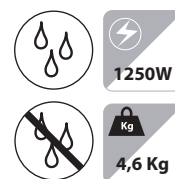

- Aspirateur eau et poussière à usage domestique, idéal pour la maison, l'atelier, le garage, la remise ou le magasin.
- Cuve en polypropylène, légère et facile d'entretien.
- Fonction souffleur pour dégager les zones difficilement accessibles (angles, recoins, trous, etc.).

GARANTIE	2
Puissance moteur (230 V - 50Hz)	1250 W
Longueur du câble	4 m
Débit d'air	58 L/S
Dépression	18 Kpa
Capacité totale	15 L
Capacité utile liquide	10 L
Diamètre d'accessoires	36
Poids Net	4,6 Kg
Référence pour pièces détachées	300 (+ N° vue éclatée)
Gencod	3661589050595
Colisage (LxlxH)	325 x 325 x 375 mm
Poids Brut	5,5 Kg
Prix	97,14€
Ecotaxe	0,83€

FOURNITURES ET ACCESSOIRES

- La machine est livrée avec 1 tuyau flexible d'aspiration (ABR302), 1 tube plastique en 3 pièces (ABR314), 1 filtre éponge (ABR324), 1 sac papier (ABR315), 1 suceur plat droit (ABR307), 1 suceur à poussières (ABR310) et notice d'utilisation.

	LEMAN	€
Filtre éponge	ABR324	4,22
Roues directionnelles	ABR305	5,75
Suceur plat	ABR307	3,67
Tuyau flexible d'aspiration (1,5 m)	ABR302	14,99
Tube rallonge plastique (34,5 cm - 3 pces)	ABR314	8,75
Filtre sac papier petit format (lot de 5 pces)	ABR315	22,76
Suceur pvc poussières et liquides	ABR310	9,73





LOASC180 (MONOPHASE)

ASPIRATEUR VIDE-CENDRES • 18 L



- Aspirateur à cendres autonome pour l'entretien des cheminées, barbecues, poêles à bois ou granulés.
- Moteur intégré au couvercle doté d'une puissance de 800 W.
- Cuve en tôle laquée, volume 18 litres.
- Clips de fermeture rapide.
- Interrupteur marche / arrêt sur le couvercle.
- Une poignée de transport.
- Calotte de protection du ventilateur moteur.
- Filtre amovible lavable équipé d'une protection totale en grille métallique.
- Aspire également : le charbon, le sable, la sciure et le verre.

GARANTIE	2
Puissance moteur (230 V - 50Hz)	800W
Débit d'air	22l/s - 79m ³ /h
Longueur du câble	4,5 m
Matériel de la cuve	Tôle laquée
Dimensions	290 x 290 x 355
Niveau de bruit	81dB (A)
Dépression	180mbar-18 Kpa
Capacité totale	18 L
Diamètre d'accessoires	38 mm intérieur
Poids Net	3,4 Kg
Référence pour pièces détachées	181 (+ N° vue éclatée)
Gencod	3661589054531
Colisage (LxIxH)	315x315x375 mm
Poids brut	4,2 Kg
Prix	64,31€
Ecotaxe	0,83€

FOURNITURES ET ACCESSOIRES

• La machine est livrée avec 1 tuyau flexible d'aspiration en métal (ABR181), 1 embout droit en aluminium (ABR182), 1 filtre cartouche HEPA (ABR183) et notice d'utilisation.



ABR181



ABR182



ABR183

	LEMAN	€
Tuyau flexible d'aspiration métal 1.1m (ø40-38)	ABR181	15,91
Embout aluminium droit 220mm (ø38)	ABR182	4,59
Filtre cartouche lavable HEPA (classe L)	ABR183	9,61



MAX180 (MONOPHASE)
MALAXEUR 2 VITESSES • 160 MM

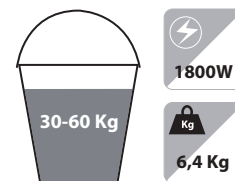

- Démarrage progressif.
- Régulateur de vitesse électronique pour un déploiement de force en douceur.
- Deux plages de régime: lent et rapide.
- Poignées ergonomiques pour un plus grand confort de travail.
- Démarrage à la gâchette avec bouton de verrouillage pour un travail en continu, avec protection contre la mise hors tension pour éviter tout redémarrage accidentel.
- Application: colle à carreaux, mortier, enduit, crépis, résine, peinture, plâtre.
- Capacité de malaxage : 30 à 60 kg.



2 modes de vitesse
Lent / rapide



Régulateur de vitesse
électronique

GARANTIE	2
Puissance moteur (230 V - 50 Hz)	1800 W
Vitesse de rotation	150-300/300-650 t/min
Vitesse	2
Fixation filtage extérieur	M14
Turbine recommandée	MAXI Ø 160 (L 590 mm)
Pression acoustique	85,8 db(A)
Puissance acoustique	96,8 db(A)
Vibration main-bras	1,5m/s2
Classe de protection	II
Poids Net	6,4 Kg
Référence pour pièces détachées	180 (+ N° vue éclatée)
Colisage (lxLxH)	655 x 420 x 255 mm
Gencod	3661589029676
Poids Brut	14 Kg
Prix	222,45€
Ecotaxe	0,42€

FOURNITURES ET ACCESSOIRES

• La machine est livrée avec une turbine ø 140 mm à trois branches, une turbine ø 160 mm à deux branches, 2 clés de montage, valisette de transport et notice d'utilisation.

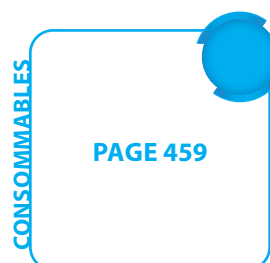



LOMAX120 (MONOPHASE) MALAXEUR 2 VITESSES • 120 MM



- Poignées ergonomiques avec revêtement « Soft Grip ».
- Démarrage progressif pour un déploiement de force en douceur.
- 2 modes mécaniques de vitesse : régime lent et régime rapide.
- Variateur électronique permettant d'adapter la vitesse de rotation à votre travail.
- Application : colles à carreaux, enduits, crépis, peintures, résines époxy, plâtres, mortiers.
- Capacité de malaxage : 15 à 25 kg.
- Démarrage à la gâchette avec bouton de déverrouillage pour éviter tout démarrage accidentel.



Bouton de déverrouillage



2 modes de vitesse
Lent / rapide

GARANTIE	2
Puissance moteur (230 V - 50 Hz)	1200 W
Vitesse de rotation	150-300/300-650 t/min
Vitesse	2
Fixation filtage extérieur	M14
Turbine recommandée	ø 120 (L 590 mm)
Pression acoustique	86 db(A)
Puissance acoustique	99 db(A)
Vibration main-bras	2,5 m/s ²
Classe de protection	II
Poids Net	5,7 Kg
Référence pour pièces détachées	120 (+ N° vue éclatée)
Colisage (lxLxH)	420 x 340 x 210 mm
Gencod	3661589046857
Poids Brut	7 Kg
Prix	121,97€
Ecotaxe	0,42€

FOURNITURES ET ACCESSOIRES

- La machine est livrée avec une turbine ø 120 mm à deux branches, 2 clés de montage et notice d'utilisation.



CAR201 (MONOPHASE) CAROTTEUSE • 2000 W



PACKCAR201 PACK CAROTTEUSE + BÂTI



Prix 2349,43€
Ecotaxe 0,42€

- Système de protection (disjoncteur différentiel PRCD) et possibilité de monter des couronnes diamantées en raccord 1/2 G(M) et 1"1/4(F).
- Boîte moteur 3 vitesses
- Indicateur de surcharge par une led
- Deux niveaux à bulle intégrés sur la poignée et le carter moteur
- Protection électrique, mécanique et thermique contre la surcharge
- Démarrage progressif contrôlé « Softstart » limitant la vitesse de démarrage



Interrupteur différentiel
10 mA(prcd)



Connecteur d'eau

GARANTIE	2
Puissance moteur (230V - 50HZ)	2000W
Vitesse de rotation à vide	930-1520-4270 t/min
Vitesse de rotation en charge	560-910-2560 t/min
Pression acoustique	97 dB(A)
Puissance acoustique	108 dB(A)
Vibration main-bras	1.5m/s2
Classe de protection	IP55
Diam maxi béton	160mm
Diam maxi brique	200mm
Raccord combiné	1"1/4 Mâle -1/2"G
Carottage à eau	OUI/ YES
Diam collerette de serrage	60mm
Poids Net	7,6 kg
Référence pour pièces détachées	2001 (+ N° vue éclatée)
Gencod	3661589053961
Colisage (Lx LxH)	600 x 195 x 390 mm
Poids Brut	12 kg
Prix	1236,68€
Ecotaxe	0,42€

FOURNITURES ET ACCESSOIRES

- La machine est livrée avec une poignée latérale, un kit d'arrosage avec raccord rapide auto-stop, un connecteur d'arrivée d'eau, une clé universelle de service, un interrupteur différentiel PRCD et une notice de montage.



25003



25008



25004



BAT250



25006A



25007

	LEMAN	€
Bâti pour perçage maxi Ø 250mm , longueur de course maxi 600mm, Pour moteur de 2000W et 2500W	BAT250	1236,40
Douille de frappe M12 Ø 16 (boîte de 50 pces)	25003	67,98
Kit de fixation : broche de serrage M12x200 avec écrous + douille M12 Ø 16 et outil de pose	25004	67,98
Pompe à vide 250W/230V - 7,2m3/hr - 10 L + 3 m de tuyau	25006A	1468,53
Kit pour vide d'air : bloc avec raccord + joint caoutchouc pour le socle du bâti D250mm	25007	113,75
Pompe à eau PVC 10L + 2,5 m de tuyau raccord	25008	220,52

POB126 (MONOPHASE)

SURFACEUSE À BÉTON • 125 MM



- Démarrage progressif « soft start »
- Variateur électronique
- Bouton de verrouillage pour un usage en continu
- Partie du carter détachable (ponçage dans les angles)
- Carter réglable en hauteur
- Sortie d'aspiration
- Moteur 2 charbons
- Poignée latérale fixation à droite ou à gauche
- Pour le ponçage, le lissage et l'ébavurage à sec des matériaux de construction (béton, pierre naturelle, granit, marbre, mortier) et pour l'élimination des résidus de colle et d'enduit.



GARANTIE	2
Puissance moteur (230 V - 50 Hz)	1600W
Vitesse de rotation	500-3000 t/min
Diamètre du plateau	Ø125 mm
Alésage du plateau	22,23 mm
Fixation plateau	vis M8 x 35
Sortie d'aspiration	ø 32 mm
Profondeur de décapage	1 à 5,5mm
Indice de protection	IP20
Encombrement L x H x E (mm)	380 x 290 x 200 mm
Pression acoustique	88,1 dB(A), K=3dB(A)
Puissance acoustique	99,1 dB(A), K=3dB(A)
Vibration main-bras	2,138 m/s ² , K=1,5m/s ²
Classe de protection	II
Poids Net	6,6 kg
Référence pour pièces détachées	600300 (+ N° vue éclatée)
Colisage (lxLxH)	505 x 420 x 205 mm
Gencod	3661589078704
Poids Brut	10,5 kg
Prix	307,60€
Ecotaxe	0,42€

FOURNITURES ET ACCESSOIRES

- La machine est livrée avec une valise de transport, un plateau diamanté double piste Ø 125 mm, 2 clés de montage, 1 poignée latérale et notice d'utilisation.



CONSOMMABLES	2500125	P. 17
	1500125	P. 17
	1100125	P. 18
	974	P. 18
	1400125	P. 29
	1750125	P. 29



STC250 (MONOPHASE)
SCIE SUR TABLE POUR CARRELAGE
• 250 MM



- Robuste et très stable avec une capacité de coupe maximale de 900 mm.
- Démontage de la table pour un nettoyage rapide et facile.
- Rail de guidage en aluminium qui offre un maximum de rigidité et de légèreté.
- Profondeur de coupe réglable montée sur ressort, et verrouillage mécanique.
- Guides de coupe gradués et mesure angulaire intégré 0° - 45°.
- Poignée, pieds pliants et roues de transport.



Pieds pliants



Tête de coupe inclinable
(0° à 45°)



Roues de transport



Guides de coupe gradués avec
mesure angulaire 0° - 45°

GARANTIE	2
Puissance moteur (230 V - 50 Hz)	1500 W - S2 (30min)
Diamètre disque max	ø 250 mm
Alésage	ø 25,4 mm
Longueur de coupe maxi	900 mm
Profondeur de coupe maxi à 90°	60 mm
Profondeur de coupe maxi à 45°	48 mm
Dimensions de la table de coupe	1010 x 503 mm
Vitesse de coupe	3000 t/min
Inclinaison de la table de coupe	0 - 45°
Indice de protection	IP54
Pompe à eau	8 W - IP28 - 600 l/H
Poids Net	65 kg
Références pour pièces détachées	250 (+ N° vue éclatée)
Colisage (LxlxH)	1410 x 605 x 560 mm
Gencod	3700501713719
Poids Brut	70 kg
Prix	922,27€
Ecotaxe	0,42€

FOURNITURES ET ACCESSOIRES

- La machine est livrée avec un guide de coupe intégré, un guide parallèle, un disque céramique jante continue ø 250 x 25,4 mm, la pompe à eau, clé et notice d'utilisation.

CONSOMMABLES

910250
960250

P. 24
P. 25

LOCSE300 (MONOPHASE)

CHAUFFAGE SOUFFLANT ÉLECTRIQUE

• 3000W



- Chauffage d'appoint idéal pour l'atelier, le garage ou le chantier.
- Appareil à usage privé ou domestique. Usage interdit autour d'une piscine, dans une salle d'eau ou une pièce de vie.
- Thermostat mécanique avec réglage de 30W à 3000W.
- Sélecteur 3 fonctions : arrêt, ventilation seule, chauffage soufflant.
- Piètement tubulaire en acier avec poignée de transport.
- Corps de chauffe orientable avec grille de protection.

GARANTIE	2
Puissance moteur (230V-50Hz)	30W
Encombrement (LxlxH)	320 x 250 x 360 mm
Puissance maximale	3000W ou 2580 kcal/h
Réglage puissance	30~3000 W
Température de sortie	85° C
Vitesse de chauffage (m ³ /h)	305 m ³ /h
Surface de chauffage à titre indicatif (m ²)	25 m ²
Fonctions	Ventilateur / Chauffage
Indice de protection	IPX4
Classe de protection	I
Poids Net	4,9 Kg
Longueur du câble	1,4 m
Référence pour pièces détachées	550000 (+ N° vue éclatée)
Gencod	3661589081230
Colisage (LxlxH)	325 x 260 x 375 mm
Poids Brut	6 Kg
Prix	91,51€
Écotaxe	1,67€

PLB020 (MONOPHASE)

PROJECTEUR DE CHANTIER LED SUR BATTERIE • 20 W



- Boîtier renforcé, en aluminium moulé sous pression avec poignée de transport.
- Projecteur orientable avec blocage dans la position choisie.
- Interrupteur marche - arrêt.
- Fonction Powerbank : port USB (5V, 1A) qui permet de recharger vos appareils comme votre smartphone, tablette, etc...
- Peut être posé, suspendu ou accroché à des surfaces métalliques à l'aide de deux puissants aimants intégrés.
- Vitre résistante aux chocs.
- IP54.

GARANTIE	2
Batterie	Li-ion 11,1V 4400 mAh
Puissance Max. (W)	20 W
LED 20W	SMD
Autonomie	3,5 H
Temps de charge	5 H
Température de la couleur	4000 K
Indice de rendu de couleur (IRC)	>80
Flux lumineux	1400 lm
Durée de vie	30000 h
Angle de rayonnement	120°
Indice de protection	IP54
Classe de protection	I
Dimensions L x H x E (mm)	195 x 220 x 65 mm
Gencod	3661589088031
Poids Net	1,4 kg
Prix	109,15€
Ecotaxe	0,42€

BLB003 (MONOPHASE)

BALADEUSE LED RECHARGEABLE



- 2 en 1 fonction baladeuse (en façade) et lampe torche (sur la tête).
- Corps en plastique renforcé ABS avec revêtement caoutchouc.
- 2 crochets escamotables et orientables à 360°.
- 2 aimants de maintien sur la face arrière du boîtier.
- Interrupteur 3 fonctions: lampe torche, baladeuse et arrêt.
- Poignée flexible orientable à 180° et aimantée.
- Témoin de charge.
- Chargeur secteur et allume-cigare inclus.
- IP20.



Crochets rotatifs à 360°



2 supports aimantés



Prise alimentation

GARANTIE	2
Batterie	Li-ion 3,7V 2000 mAh
Puissance Max. (W)	3 W + 1 W
LED	COB
Autonomie	8-9 h + 3-4 h
Température de la couleur	6000 K
Flux lumineux	210 lm + 90 lm
Durée de vie	30000 h
Angle de rayonnement	110°
Indice de protection	IP20
Dimensions de la lampe L x H x E (mm)	56 x 250 x 35 mm
Poids Net	0,24 kg
Gencod	3661589088055
Prix	44,10€
Ecotaxe	0,42€



info@leman-sa.com

MACHINES MÉTAL

SCIES À RUBAN

P. 532

PERCEUSES D'ÉTABLI - À COLONNE

P. 536



SRM100 (MONOPHASE)

SCIE À RUBAN MÉTAL MANUELLE · 100 MM



- Scie à ruban pour métaux, légère et compacte, idéale également pour les chantiers.
- Socle en fonte d'aluminium avec 4 patins en caoutchouc réglables.
- Descente manuelle de l'archet avec ressort de rappel.
- Archet pivotant jusqu'à 45°.
- Butée de longueur pour les coupes répétitives.
- Poignée de commande avec gâchette de démarrage.
- Poignée de détente rapide de la lame, guides de lame à roulements
- Variateur électronique pour adapter la vitesse de coupe au matériau.



Variateur de vitesse,
détente rapide de la lame.

GARANTIE	2
Puissance moteur (230V - 50Hz)	1500W-56/10%
Dimensions de lame HSS bi-métal M42	1140 x 13 x 0,65 mm
Vitesse de coupe	20-70 m/min
Etau de serrage	105 mm
Montée de l'archet	Manuelle
Descente	Manuelle
Capacité de coupes maxi à 90° <input type="radio"/> <input type="checkbox"/>	100 mm - 100 x 105 mm
Capacité de coupes maxi à 45° <input type="radio"/> <input type="checkbox"/>	55 mm - 55 x 60 mm
Dimensions avec archet en position haute(LxlxH)	600 x 560 x 580 mm
Pression acoustique	87,3 / 88,4 dB(A)
Puissance acoustique	96,2 / 97,4 dB(A)
Vibration poignée principale	0,971 m/s ²
Poids Net	18 Kg
Référence pour pièces détachées	800400 (+ N°/vue éclatée)
Gencod	3661589084828
Collisage (LxlxH)	560 x 370 x 410 mm
Poids Brut	20 Kg
Prix	498,57€
Ecotaxe	2,08€

FOURNITURES ET ACCESSOIRES

- La machine est livrée avec 1 butée de longueur, 1 jeu de charbons de rechange, 4 pieds réglables, 1 lame HSS bi-métal 14TPI, clés et notice d'utilisation.

CONSOMMABLES

LEM214 À 217
PAGE 148

SRM125 (MONOPHASE)

SCIE À RUBAN MÉTAL MANUELLE · 125 MM



- Moteur à courant continu sans balais: haut rendement, durabilité, niveau sonore réduit, pas d'entretien
- Machine légère et transportable, idéale pour les chantiers et le travail sur site
- Descente manuelle de l'archet avec ressort de rappel
- Archet pivotant jusqu'à 60°
- Butée de longueur pour les coupes répétitives
- Interrupteur électromagnétique, témoin de mise sous tension, poignée de commande avec gâchette de démarrage
- Poignée de réglage de la tension de la lame, guides de lame avec roulements
- Variateur électronique pour adapter la vitesse de coupe au matériau



Variateur de vitesse
Bouton de réarmement
Témoin de mise sous tension



Poignée de réglage de la tension
de la lame

Tension/Fréquence	230 V / 50 Hz
Puissance Moteur	400 W - S6 (30%)
Vitesse de Rotation	2000-4200 t/min
Dimensions de la lame	1435 x 12,7 x 0,65 mm
Vitesse de Coupe	38-80 m/min
Ouverture Etau	125 mm
Pivotement de l'archet	0° à 60°
Descente de l'archet	Manuelle
Montée de l'archet	Assistée
Capacités de coupe à 90° <input type="checkbox"/>	Ø125 mm / 127x125 mm
Capacités de coupe à 45° <input type="checkbox"/>	Ø80 mm / 80x100 mm
Pression Acoustique LpA	77 dB(A) à vide
Puissance Acoustique LwA	90 dB(A) à vide
Poids Net	23 kg
Poids Brut	25 kg
Encombrement (LxlxH)	630 x 310 x 690 mm
Dimensions Colisage	730 x 383 x 455 mm
Racine Pièces Détachées	800500
Gencod	3661589103642
Prix	556,82€
Ecotaxe	2,08€

FOURNITURES ET ACCESSOIRES

- La machine est livrée avec une butée de longueur, une lame hss bi-métal 8/12tpi et une notice d'utilisation.

CONSOMMABLES

LEM218 À 221
PAGE 148



SRM150 (MONOPHASE)

SCIE À RUBAN MÉTAL MANUELLE · 150 MM



- Bâti et archet de scie en fonte grise massive
- Orientation de l'archet de 0° à 60° à gauche pour les coupes à l'équerre
- Interrupteur IP54 basse tension avec arrêt d'urgence (coup de poing)
- Marche par appui sur gachette
- Guide lame par roulements
- Étau à serrage rapide
- Descente manuelle de l'archet avec ressort de rappel
- Tension de lame réglable par volant
- Dispositif de lubrification par 2 points en électro-pompe
- Système complet d'arrosage avec bac récupérateur de fluide
- Butée de coupe réglable pour les pièces en série
- Transmission par réducteur coaxial
- Équipée de série d'une lame Bi-métal haute qualité
- Equipée d'un rouleau pour amener les pièces de grandes longueurs
- Livrée de série avec socle



Étau à serrage rapide.



Archet orientable de 0° à 60° à gauche pour des coupes à l'équerre.

GARANTIE	2
Puissance moteur (230V - 50HZ)	550W-S1
Dimensions de lame HSS bi-métal M42	1735 x 13 x 0.65mm
Vitesse de coupe	34 m/min
Étau de serrage	170mm
Montée de l'archet	Manuelle
Descente	Assistée par ressort
Capacité de coupes maxi à 90°	150-150-150x140mm
Capacité de coupes maxi à 45°	115-115-115x140mm
Capacité de coupes maxi à 60°	70-70-70x90mm
Hauteur de travail	850mm
Dimensions avec archet en position haute(LxIxH)	1020X470X1520mm
Dimensions avec archet en position basse(LxIxH)	1020X470X1270mm
Poids net (socle inclus)	95 kg
Références pour pièces détachées	1500(+N°vue éclatée)
Colisage n°1 machine (LxIxH)	930X470X480mm
Colisage n°2 stand (LxIxH)	740X540X330mm
Gencod	3661589056801
Poids brut	101 kg
Prix	1109,16€
Ecotaxe	2,08€

FOURNITURES ET ACCESSOIRES

- La machine est livrée avec une lame HSS bi-métal 14TPI, un socle, une butée de coupe, clés de serrage, un rouleau de guidage pour les pièces et notice d'utilisation.

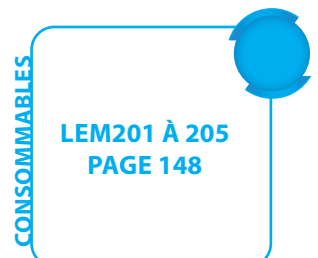

LEM201 À 205
PAGE 148



SRM170 (MONOPHASE) SCIE À RUBAN MÉTAL AUTOMATIQUE · 170 MM



- Bâti et archet de scie en fonte grise massive.
- Une vitesse continue.
- Orientation de l'archet de 0° à 60° à gauche pour les coupes à l'équerre.
- Un levier verrouillable pour l'orientation de l'archet.
- Grande précision de coupe par une excellente rigidité.
- Panneau de commande pour une utilisation simple.
- Commande basse tension 24V avec arrêt d'urgence (coup de poing).
- Gachette par appui en «Mode manuel».
- Guidage de lame ajustable et très précis par roulements 8 points.
- Étau à serrage rapide avec levier à rattrapage de jeu.
- Descente de l'archet réglable par vérin hydraulique.
- Montée de l'archet manuelle avec ressort de rappel ajustable.
- Arrêt automatique en fin de coupe.
- Carter ruban équipé d'un microrupteur de sécurité.
- Dispositif de lubrification par 2 points en électro-pompe.
- Système complet d'arrosage avec bac récupérateur de fluide.
- Butée de coupe réglable pour les pièces en série.
- Transmission par réducteur coaxial et vis sans fin.
- Équipée de série d'une lame Bi-métal haute qualité.
- Équipée d'un rouleau pour amener les pièces de grandes longueurs.
- Livrée de série avec socle.



Guidage de lame ajustable et très précis par roulements 8 points.



Descente de l'archet par vérin hydraulique avec débit réglable.



Étau à serrage rapide avec levier à rattrapage de jeu.

Garantie	2
Puissance moteur (230V-50hz) SRM170	900W-S1
Dimensions de lame HSS bi-métal M42	2110 x 20 x 0.90mm
Vitesse de coupe (moteur mono 220V)	80 m/min
2 Vitesses de coupe (moteur tri 380V)	40-80m/min
Étau de serrage	230mm
Montée de l'archet	Manuelle
Descente	Par vérin , débit réglable
Capacité de coupes maxi à 90°	170-170-210x140mm
Capacité de coupes maxi à 45°	120-120-110x110mm
Capacité de coupes maxi à 60°	70-70-60x60mm
Hauteur de travail <input type="radio"/> <input type="checkbox"/>	960mm
Dimensions avec archet en position <input type="radio"/> <input type="checkbox"/> e(LxlxH)	1180X500X1650mm
Dimensions avec archet en position <input type="radio"/> <input type="checkbox"/> e(LxlxH)	1180X500X1470mm
Poids net (socle inclus)	162 kg
Références pour pièces détachées	1700(+N°vue éclatée)
Colisage n°1 machine (LxlxH)	1260X550X900mm
Colisage n°2 stand (LxlxH)	880X560X150mm
Gencod	3661589056818
Poids brut	190 kg
Prix	2098,89€
Ecotaxe	2,08€

FOURNITURES ET ACCESSOIRES

- La machine est livrée avec une lame HSS bi-métal variable 5/8TPI, un socle, une butée de coupe, clés de serrage et un rouleau de guidage pour les pièces et notice d'utilisation.

CONSOMMABLES

LEM206 À 209
PAGE 148



PRE020 (MONOPHASE) - PRC020 (MONOPHASE) PERCEUSE D'ÉTABLI ET PERCEUSE À COLONNE



- Table, base et tête de perçage en fonte d'acier grise.
- Base percée pour pouvoir fixer la machine au sol (PRC020) ou sur un établi (PRE020).
- Broche montée sur roulements à billes.
- Table orientable à 360° et inclinable jusqu'à 45° avec gorge de récupération de lubrifiant.
- Montée et descente de la table par crémaillère.
- Butée de profondeur réglable.
- Bras de cabestan équipés de poignées «Softgrip».
- Étau avec mors de 100 mm (4") pour la fixation des pièces.
- Mandrin auto-serrant B18.



Bouton d'arrêt d'urgence
«Coup de poing»



Poulies en acier



Carter de mandrin basculant
et réglable

	PRE020	PRC020
GARANTIE	2	2
Puissance moteur (230 V - 50 Hz)	600W-S1	600W-S1
Vitesse de rotation du moteur	1400 t/min	1400 t/min
Encombrement (L x l x H)	690 x 350 x 1060 mm	690 x 350 x 1630 mm
Capacité de perçage	20 mm	20 mm
Cône Morse de broche	CM2	CM2
Diamètre de colonne	73 mm	73 mm
Course de broche	80 mm	80 mm
Nombre de vitesses	12	12
Vitesse de broche	180 - 2740 t/min	180 - 2740 t/min
Col de cygne	190 mm	190 mm
Distance broche table	470 mm	700 mm
Distance broche base	600 mm	1190 mm
Diamètre de broche	47 mm	47 mm
Dimensions table	305 x 305 mm	305 x 305 mm
Dimensions base	485 x 290 mm	485 x 290 mm
Poids Net	55 Kg	61 Kg
Référence pour pièces détachées	830300(+ N° vue éclatée)	830200 (+ N° vue éclatée)
Gencod	3661589071651	3661589071668
Collisage (L x l x H)	800 x 500 x 300 mm	1410 x 490 x 235 mm
Poids Brut	58 Kg	64 Kg
Prix	501,45€	573,57€
Écotaxe	2,08€	2,08€

FOURNITURES ET ACCESSOIRES

- La machine est livrée avec l'arbre porte-mandrin CM2-B18, un mandrin auto-serrant B18, un chasse-cône, un étau de serrage avec mors de 100mm, clés et notice d'utilisation.



ABR701

ABR704



ABR702

ABR705

	LEMAN	€
Arbre porte mandrin CM2-B18	ABR701	15,60
Mandrin auto-serrant B18	ABR702	122,07
Un chasse cône	ABR704	9,18
Étaux de perçage largeur MORS 100mm	ABR705	45,77

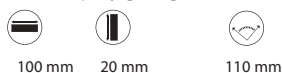

ENTRAXE

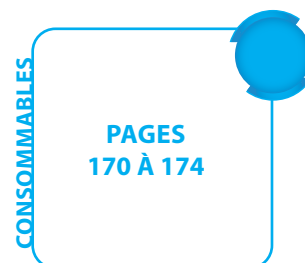



PRC016 (MONOPHASE) PERCEUSE RADIALE À COLONNE



- Précision de rotation garantie <0,03mm mesurée sur l'axe de perçage.
- Moteur aluminium.
- Axe équipé de roulements à billes.
- Montée et descente de la table par crémaillère.
- Coulisement de la tête par crémaillère jusqu'à 420 mm.
- Table tournante et inclinable à 45° et orientable à 360°.
- Socle robuste avec rainure en « T » et renforts arrières.
- Mandrin auto-serrant B16 livré de série.
- Butée de profondeur réglable.



Tête pivotante et radiale



Poulies en aluminium



Carter de mandrin basculant et réglable

GARANTIE	2
Puissance moteur (230 V - 50 Hz)	550W-S1
Alimentation Volt	230V/50hz
Capacité de perçage	16 mm
Cône Morse de broche	CM2
Diamètre de colonne	70 mm
Course de broche	80 mm
Nombre de vitesses	5
Vitesse de broche	500-2450
Col de cygne	420mm
Inclinaison de la tête	90° Gauche/ 45° Droite
Rotation de la tête	360°
Distance broche table	770mm
Distance broche base	1280mm
Diamètre de broche	40mm
Dimensions table	310mm
Dimensions base	420 x 250 mm
Dimensions (LongxLargxHauteur)	850 x 310 x 1620 mm
Poids net	61 kg
Référence pour pièces détachées	016 (+ N° vue éclatée)
Gencod	3661589046567
Collisage(LongxLargxHauteur)	1420 x 500 x 260
Poids brut	64 kg
Prix	572,54€
Ecotaxe	2,08€

FOURNITURES ET ACCESSOIRES

- La machine est livrée avec l'arbre porte mandrin CM2 - B16, un mandrin auto-serrant B16, un chasse cône, 1 kit visserie pour fixation des socles, clés et notice d'utilisation.

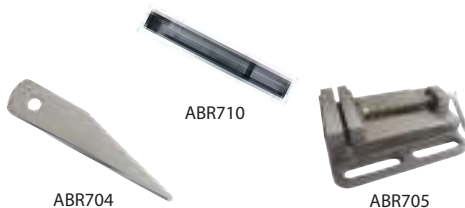

	LEMAN	€
Arbre porte mandrin CM2-B16	ABR710	112,34
Un chasse cône	ABR704	9,18
Étaux de perçage largeur MORS 100mm	ABR705	45,77

	ENTRAXE
	100 mm
	20 mm
	110 mm
	135 mm

CONSOMMABLES

PAGES
170 À 174



info@leman-sa.com

MACHINES OUTDOOR

SCIE À BUCHES **P. 540**

FENDEUSE À BUCHES **P. 541**

TARIÈRE **P. 542**



LOSAB601LC (MONOPHASE) SCIE À BÛCHE • Ø 600 MM



- Machine conforme à la nouvelle Norme NF EN 1870-6.
- Bâti mécanosoudé offrant robustesse, stabilité, et une résistance maximale à la torsion.
- Ancrage au sol possible.
- Moteur asynchrone de 3500W, robuste et puissant.
- 2 roues Ø200mm et large poignée pour un déplacement aisé.
- Interrupteur électromagnétique avec couvercle arrêt «coup de poing».
- Chariot de coupe et protecteur supérieur inter-verrouillés pour un travail en toute sécurité.
- Poignée de chariot réglable en hauteur pour plus de confort.
- Butée de longueur pour les coupes répétitives, rallonge de chariot coulissante pour les grandes longueurs.



Inter-verrouillage



Protecteur supérieur avec poignée réglable

GARANTIE	2
Puissance moteur (230V- 50HZ)	3500 W - S6 40%
Vitesse de rotation de la lame	1420 Tr/min
Encombrement (LxlxH)	1340 x 807 x 1240mm
Diamètre de la lame	600 mm
Alésage de la lame	30 mm
Diamètre de coupe	Ø Mini 80mm / Ø Maxi 210mm
Hauteur poignée de chariot	850 à 1150mm
Poids Net	97 Kg
Référence pour pièces détachées	300700 (+ N° vue éclatée)
Gencod	3661589098900
Collisage	1080 x 830 x 1220 mm
Poids Brut	123 Kg
Prix	1166,00€
Ecotaxe	2,08€

FOURNITURES ET ACCESSOIRES

- La machine est livrée avec les roues de déplacement, la butée de longueur, la rallonge de chariot, une lame carbure Ø600 de 40 dents, clés et notice d'utilisation.



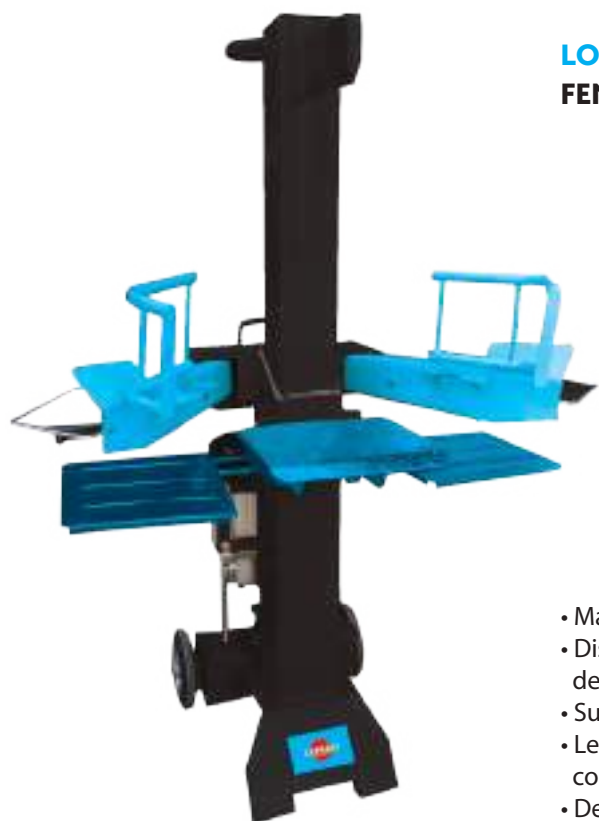

LOFEV082 (MONOPHASE) FENDEUSE À BÛCHE VERTICALE • 8 T



- Machine conforme à la nouvelle Norme NF EN 609-1.
- Dispositif de commande bi-manuelle, griffes de maintien, capots et arcs de protection des mains pour travailler en toute sécurité.
- Supports maintenant la bûche après l'opération de fendage.
- Leviers de commande avec poignées en caoutchouc pour un meilleur confort .
- Deux plateaux de stockage: un pour l'alimentation des bûches, un pour les pièces fendues.

GARANTIE	2
Puissance moteur	(230V-50Hz) : 3000 W - S6/40%
Encombrement (LxlxH)	955 x 750 x 1575 mm
Puissance de fendage	8 Tonnes
Vitesse de fendage	5 cm/s (±0,5 cm/s)
Vitesse de remontée du coin	12 cm/s (±0,5 cm/s)
Diamètre de bûche mini/maxi	70/400 mm
Longueur de bûche mini/maxi	300/550 mm
Pression hydraulique	24 MPa
Capacité du réservoir d'huile hydraulique	6 L
Type d'huile	HV46 ou HLP46
Poids Net	112 kg
Référence pour pièces détachées	310500 (+ N° vue éclatée)
Gencod	3661589096265
Colisage (LxPxH)	560 x 440 x 1090 mm
Poids Brut	118 kg
Prix	848,25€
Ecotaxe	0,42€

FOURNITURES ET ACCESSOIRES

- La machine est livrée avec de l'huile hydraulique, les roues de transport et la notice d'utilisation.



LOTAR052 (THERMIQUE)
TARIÈRE THERMIQUE • 52 CM3



- Tarière thermique idéale pour la réalisation de petites fondations, pour l'installation de poteaux, de piquets, de clôtures et pour la plantation de haies et d'arbustes.
- Poignées ergonomiques avec revêtement «Soft Grip» pour un plus grand confort d'utilisation.

GARANTIE	2
Type de moteur	Essence
Cylindrée du moteur	52 cm ³
Puissance moteur	1700W
Vitesse de rotation du moteur	9500tr/min
Machine débrayable	X
Carburateur	à membrane
Démarrage	au lanceur + starter
Capacité du réservoir	1,1 L
Carburant	Mélange 2,5 à 4%
Diamètre des mèches	100mm/150mm/200mm
Nombre de mèches	3
Longueur des mèches	800 mm
Diamètre maxi des mèches	300mm
Fixation de la mèche	Goupille clips 8x50 mm
Vitesse de rotation de la mèche	280 tr/min
Poids Net (Sans mèche et sans carburant)	9,5 K
Référence pour pièces détachées	360000 (+ N° vue éclatée)
Gencod	3661589054524
Colisage	1230x400x300mm
Poids Brut	22 Kg
Prix	406,56€

FOURNITURES ET ACCESSOIRES

- La machine est livrée avec 3 mèches (Ø 100, 150 et 200 mm), un récipient pour faire les mélanges de carburant, un entonnoir, une clé à bougie, 2 clés BTR et la notice d'utilisation.

	LEMAN	€
Mèche Ø 100 MM	360001	28,09
Mèche Ø 150 MM	360002	33,65
Mèche Ø 200 MM	360003	39,22
Mèche Ø 300 MM	360004	67,31
Rallonge de 400 MM	360005	22,52

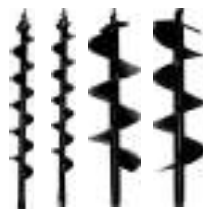



PROCÉDURE SAV - Revendeur

MACHINES sous garantie

- Machines garanties de 2 ans pour toutes les pièces (Hors pièces d'usures : lame, fers, charbons, courroie,...).
- Toutes demandes SAV doivent être effectuées en joignant la facture du client utilisateur + Référence machine + N° de série de la machine ainsi que le N° de la vue éclatée pour la pièce défectueuse.
- Tous les retours doivent être validés par le responsable SAV : Tél : 04.74 .83.69.88 ou par email : sav@leman-sa.com et non par le commercial.

L'envoi de toutes les pièces est gratuit mais la main d'œuvre est à réaliser par le revendeur ou l'utilisateur.

- Pour les échanges machines, l'envoi est effectué au retour du produit défectueux.

Les frais de port de retour en nos locaux sont à notre charge si un défaut est constaté sous un délai de 8 jours après livraison.

Si ce délai est dépassé ceux-ci seront à la charge du revendeur ou utilisateur.

L'expédition de la machine neuve ou réparée sera à notre charge.

Le Revendeur ne souhaite ou ne peut pas assurer le SAV :

- Nous avons un forfait pour toutes réparations en interne si le revendeur ne peut pas assurer le suivi (voir code produit MOE030). Ce barème est facturé par tranche de 30 minutes.

Délai d'intervention de 10 jours suite à la réception du produit défectueux.

- Les frais de port aller et retour sont à la charge du revendeur ou utilisateur.

MACHINES hors garantie

- Toutes demandes SAV doivent être effectuées en joignant la facture (facultatif) + Référence machine + N° de série de la machine (facultatif) ainsi que le N° de la vue éclatée pour la pièce défectueuse.
- Tous les retours doivent être validés par le responsable SAV : Tél : 04.74 .83.69.88 ou par email sav@leman-sa.com et non par le commercial.
- L'envoi de toutes les pièces est facturé et la main d'œuvre est à réaliser par le revendeur ou l'utilisateur.
- Les frais de port aller et retour sont à la charge du client.

Le Revendeur ne souhaite ou ne peut pas réaliser la réparation:

- Nous avons un forfait pour toutes réparations en interne si le revendeur ne peut pas assurer le suivi (voir code produit MOE030). Ce barème est facturé par tranche de 30 minutes.

Délai d'intervention de 10 jours suite à la réception du produit défectueux.

- Les frais de port aller et retour sont à la charge du revendeur ou utilisateur.

PROCÉDURE SAV - Utilisateur

Se reporter aux notices dans chapitre CERTIFICAT DE GARANTIE.

Conditions de la garantie:

- Ce produit est garanti pour une période de (un an ou deux ans) à compter de la date d'achat (bon de livraison ou facture).
- Les produits de marque LEMAN sont tous testés suivant les normes de réception en usage.
- Votre revendeur s'engage à remédier à tout vice de fonctionnement provenant d'un défaut de construction ou de matières.
- La garantie consiste à remplacer gratuitement les pièces défectueuses. Cette garantie n'est pas applicable en cas d'exploitation non conforme aux instructions d'utilisation de la machine, ni en cas de dommages causés par des interventions non autorisées ou par négligence de l'acheteur.
- Cette garantie se limite au remplacement pur et simple et sans indemnité des pièces défectueuses.
- Toute réparation faite au titre de la garantie ne peut avoir pour effet de proroger sa date de validité.
- Les réparations ne donnent lieu à aucune garantie.
- Les réparations au titre de la garantie ne peuvent être effectuées que dans les ateliers de votre revendeur ou de ses ateliers agréés.
- Le coût du transport du matériel reste à la charge du client.
- Procédure à suivre pour bénéficier de la garantie :
- Pour bénéficier de la garantie, le présent certificat de garantie devra être dûment rempli et envoyé à votre revendeur avant de retourner le produit défectueux.
- Une copie de la facture ou du bon de livraison indiquant la date, le type de la machine et son numéro de référence devra accompagner votre demande.
- Dans tous les cas un accord préalable de votre revendeur sera nécessaire avant tout envoi.

Référence du produit (celle de votre revendeur) :

Descriptif de la pièce défectueuse :

Modèle (...) :

Nom du produit :

Votre N° de client :

Votre nom :

Numéro de série :

Tél. :

Votre adresse :

N° de facture ou N° du bon de livraison :

(Pensez à joindre une copie de la facture ou du bordereau de livraison)

Date de votre demande :

Signature :

Date d'achat :

Description du défaut constaté :

CONDITIONS GENERALES DE VENTES 2021

I. OBJET

1. Les présentes ci-après dénommées « les Conditions Générales » ont pour objet de définir l'ensemble des modalités et conditions générales de vente de produits commandés, ci-après « les Produits », par le client, ci-après dénommé « le Client », à la société LEMAN, ci-après dénommée « LEMAN », ci-après dénommés collectivement « les Parties ».
2. Les relations contractuelles entre les Parties sont régularisées par un document définissant les modalités et conditions particulières de vente des Produits commandés par le Client, ci-après « le Contrat ».
3. La régularisation du Contrat implique l'acceptation préalable des présentes Conditions Générales. En conséquence, le Client reconnaît être parfaitement informé du fait que son accord concernant le contenu des présentes Conditions Générales, ne nécessite pas la signature manuscrite de ce document.
4. Les présentes Conditions Générales s'appliquent à chaque Contrat régularisé entre les Parties, quelles que soient les clauses pouvant figurer sur les documents du Client, et notamment ses conditions générales d'achat, sur lesquelles les présentes Conditions Générales prévalent.
5. LEMAN se réserve la possibilité d'adapter ou de modifier à tout moment les présentes Conditions Générales. En cas de modification, il sera appliqué à chaque commande les Conditions Générales en vigueur au jour de la commande.
6. Le fait pour LEMAN de ne pas se prévaloir à un moment donné de l'une quelconque des présentes Conditions Générales, ne peut valoir renonciation à s'en prévaloir ultérieurement.
7. Tout autre document que les présentes conditions générales de vente et notamment catalogues, prospectus, publicités, notices, n'a qu'une valeur informative et indicative, non contractuelle.

II. FORMATION DU CONTRAT

1. Le Contrat est réputé conclu à la date de réception par LEMAN de son devis dûment accepté, daté et signé par le Client ou de la confirmation écrite par LEMAN d'un bon de commande établi par le Client. L'acceptation de la commande par LEMAN pourra néanmoins résulter de la livraison des Produits commandés. Le devis devra être accepté par le Client dans le délai de validité de 60 jours à compter de son émission, sauf stipulations contraires.
2. Un Contrat ne peut être ni modifié, ni annulé, sans l'accord express, écrit et préalable de LEMAN, faute de quoi l'intégralité du prix des Produits sera facturé au Client et sera immédiatement exigible.
3. LEMAN se réserve le droit d'apporter à tout moment toute modification qu'il juge utile à ses Produits, sans obligation de modifier les Produits précédemment livrés ou en cours de commande.

III. CONDITIONS FINANCIERES - PAIEMENT

1. Prix

1.1 Sauf conditions particulières indiquées dans le devis établi par LEMAN, les prix des Produits objets de la vente figurent sur le catalogue LEMAN en vigueur au moment de la commande. A la date de formation du Contrat, les prix sont fermes et définitifs. Les commandes passées au-delà du délai de validité des devis ou offres de prix seront soumises aux tarifs ou barèmes de prix de LEMAN en vigueur au jour de la confirmation de la commande par LEMAN.

1.2 Les prix sont présentés hors taxes, la TVA s'appliquant en sus.

1.3 LEMAN se réserve le droit de modifier les prix des produits à tout moment. Toutefois, les Produits pour lesquels des commandes ont été passées seront facturés au prix convenu au moment de la commande.

2. Conditions de paiement

2.1 LEMAN se réserve le droit d'exiger du Client le paiement d'un acompte à la commande ou la constitution de garanties ou de sûretés.

2.2 Les factures de LEMAN sont payables à 45 jours fin de mois, sauf conditions particulières. Le paiement par le Client est irrévocable. En aucun cas les paiements qui sont dus à LEMAN ne peuvent être suspendus ni faire l'objet d'une quelconque réduction ou compensation sans accord écrit de sa part. Aucun escompte ne sera accordé en cas de paiement anticipé. Les paiements sont toujours considérés comme s'appliquant en premier lieu aux intérêts de retard puis à la dette la plus ancienne.

2.3 Tout paiement par lettre de change relevé entraînera la facturation de frais administratifs supplémentaires par facture.

2.4 En cas de retard de paiement des sommes dues par le Client, des pénalités de retard, calculées au taux d'intérêt appliqué par la Banque centrale européenne à son opération de refinancement la plus récente majoré de 10 points de pourcentage, du montant TTC du prix des Produits figurant sur la facture, seront automatiquement et de plein droit dues par le Client, sans formalité aucune ni mise en demeure préalable. Il sera dû en outre, de plein droit, une indemnité forfaitaire d'un montant de 40 € pour frais de recouvrement en cas de paiement à une date ultérieure à celle figurant sur la facture. Si les frais de recouvrement sont supérieurs à ce montant forfaitaire, une indemnisation complémentaire sera due, sur présentation des justificatifs.

2.5 En cas de retard de paiement des sommes dues par le Client :

- la totalité des sommes dues par ses soins, à quelque titre que ce soit à LEMAN, deviendra de plein droit et sans accomplissement d'aucune formalité judiciaire immédiatement exigible ;
- LEMAN se réserve le droit suspendre toutes les commandes en cours ;
- LEMAN pourra également se prévaloir des dispositions de l'article VII et XI des présentes Conditions Générales.

IV. LIVRAISON

1. La livraison des Produits est réalisée par leur remise directe soit au Client, soit au transporteur ou au prestataire désigné par lui ou, en cas d'accord des Parties, choisi par LEMAN et ce au départ des locaux de LEMAN. En l'absence d'instructions du Client, la livraison est considérée comme effectuée par un simple avis de mise à disposition, les Produits étant alors gardés et entreposés, aux frais, risques et périls du Client.
2. LEMAN est autorisé à procéder à des livraisons de façon globale ou partielle, sauf instructions expresses contraires préalables à l'acceptation de la commande.
3. Les délais de livraison sont donnés à titre strictement indicatif et ne constituent pas des délais de rigueur, les dépassements ne peuvent donner lieu à d'éventuelles pénalités, indemnités ou résolution du Contrat. Les clauses pénales figurant le cas échéant sur les documents commerciaux du Client sont donc inopposables à LEMAN.
4. En toute hypothèse, la livraison dans les délais ne peut intervenir que si le client est à jour de ses obligations envers LEMAN, quelle qu'en soit la cause.
5. Les données mentionnées dans les descriptifs ou catalogues sont données sous réserve d'éventuelles erreurs typographiques, d'impression ou de toute autre nature. Elles ne peuvent être invoquées pour refuser ou contester la livraison des produits.
6. Dans le cas où le Client souhaite charger LEMAN de l'installation des Produits, cette prestation fera l'objet d'une facturation supplémentaire. Un bon d'installation sera régularisé par le Client.

V. TRANSFERT DES RISQUES

Le transfert des risques des Produits vendus ou objets de la Prestation intervient à la date de la livraison telle que définie à l'article IV des présentes. L'expédition et le transport se font par conséquent aux risques et périls du Client. Le Client supportera ainsi l'ensemble des frais et risques relatifs à l'enlèvement et au transport des Produits vendus quel que soit le mode de transport et même dans le cas où les Parties auront convenu que le transporteur sera choisi par LEMAN. Il appartient au Client, en cas de manquants, de retards ou d'avaries survenues au cours du transport, de les notifier au transporteur, dans les trois jours de la réception par acte extrajudiciaire ou par lettre recommandée, et d'exercer tous les recours prévus aux articles L 133-3 et L 133-4 du Code de commerce.

VI. RESERVE DE PROPRIETE

1. LEMAN se réserve la propriété des Produits jusqu'au paiement intégral de leur prix par le Client. Ne constitue pas un paiement au sens de cette clause la remise d'une traite ou d'un chèque.
2. En cas de non-paiement du prix aux échéances convenues, LEMAN pourra à tout moment reprendre immédiatement possession des Produits en quelque lieu qu'ils se trouvent et mettre fin au Contrat de plein droit et sans accomplissement d'aucune formalité judiciaire par simple lettre recommandée avec accusé de réception.
3. En cas de transformation du Produit, la clause de réserve de propriété s'appliquera alors sur le produit transformé. En cas de revente du Produit par le Client, soit en l'état, soit après transformation, le Client s'oblige à transférer à LEMAN le prix payé par le sous-acquéreur à due concurrence du prix des Produits restant à payer.

VII. RESERVES A LA LIVRAISON

1. Le Client doit vérifier l'état, le nombre et la conformité des Produits au moment de la livraison. Le Client doit indiquer par écrit, par courrier recommandé avec AR, à LEMAN dans les trois (3) jours calendaires suivant la livraison des Produits toute réserve concernant les Produits. Il devra également notifier au transporteur, dans le même délai, lesdites réserves conformément à l'article VI des présentes. A défaut de notification (à LEMAN et au transporteur) dans les 3 jours, aucune réclamation ne pourra plus être prise en charge par LEMAN et sa responsabilité ne saurait être engagée.
2. Dans le cas où des réserves seraient émises, il appartiendra au Client de fournir toute justification quant à la réalité des défauts, non-conformités ou dommages éventuellement constatés. Il devra laisser à LEMAN toute facilité pour procéder à la constatation de ces anomalies et pour y apporter un plan de solution adéquate. Si le Client intervient lui-même ou fait intervenir un tiers pour résoudre une anomalie, LEMAN déclinera toute responsabilité vis-à-vis des anomalies alléguées.
3. Aucun retour de Produits ne pourra être effectué par le Client sans l'accord préalable et écrit de LEMAN. Les frais de retour ne seront à la charge de LEMAN que dans le cas où la réserve du client est effectivement constatée par lui ou son mandataire.
4. Lorsque, après contrôle, une non-conformité, un défaut, un manquant ou dommage est effectivement constaté par LEMAN ou son mandataire, LEMAN procédera, à son choix, au remplacement des parties défectueuses ou à leur remboursement, sans que le Client puisse prétendre à une quelconque indemnité de quelque nature que ce soit ou à la résiliation de la commande.
5. La réclamation effectuée par le Client dans les conditions et selon les modalités décrites par le présent article ne suspend pas son obligation de payer les produits concernés.

VIII. GARANTIE – RESPONSABILITE

Le Client renonce expressément à réclamer à LEMAN tout dommage indirect ou immatériel (tels que pertes d'exploitation, préjudice commercial, etc.) qu'il pourrait subir ou qui pourrait être réclamé par un tiers dans le cadre de l'exécution du Contrat.

En cas de manquement de LEMAN, sa responsabilité sera en tout état de cause limitée au montant hors taxe du Contrat.

IX. FORCE MAJEURE

En cas de survenance d'un événement hors du contrôle de LEMAN empêchant ou retardant l'exécution de la livraison et notamment en cas de force majeure, de manque de matières premières, de difficultés imprévues dans la production, de limitation ou d'arrêt de la production, de difficultés avec les sous-traitants ou fournisseurs, de grèves, de perturbation économique ou politique par un événement tel que la guerre, la guerre civile, l'embargo ou encore de difficultés de transport, ou d'événements assimilables tels qu'intempéries, la responsabilité de LEMAN ne pourra pas être engagée. Les délais de livraison seront allongés en conséquence.

LEMAN sera dans ces hypothèses en droit de résilier de plein droit le Contrat, sans accomplissement d'aucune formalité judiciaire, par simple lettre recommandée avec accusé de réception.

X. RESILIATION

1. En cas de manquement par le Client aux obligations des présentes Conditions Générales ou du Contrat, et notamment celles visées aux articles III et XIII des présentes, LEMAN pourra résilier de plein droit la commande en cause et tout ou partie des commandes en cours, qu'elles soient livrées ou en cours de livraison, et que leur paiement soit échu ou non, sans accomplissement d'aucune formalité judiciaire, sans préjudice des dommages et intérêts auxquels elle pourrait prétendre. La décision de résiliation sera notifiée par lettre recommandée avec accusé de réception.
2. Tout acompte versé par le Client restera acquis à LEMAN, sans préjudice de toutes autres actions qu'elle serait en droit d'intenter de ce fait à l'encontre du Client.
3. Le Client devra restituer par retour à ses frais les Produits objets des Contrats résiliés. A défaut, il pourra y être contraint en référé.

XI. CLAUSE PENALE

En cas d'action judiciaire ou toute autre action en recouvrement de créance engagée par LEMAN, les frais de sommation, de justice ainsi que les honoraires d'avocat et d'huissier et tous les frais annexes seront à la charge du client fautif ainsi que les frais liés ou découlant du non-respect par le client des conditions de paiement ou de livraison de la commande considérée. Par ailleurs et à titre de clause pénale, le client devra s'acquitter d'une indemnité égale à 15 % du montant total hors taxes de la facture à recouvrer.

XII. PROPRIETE INTELLECTUELLE

L'exécution du Contrat n'entraîne pas cession au profit du Client des droits de LEMAN sur les méthodes, procédés, savoir-faire, plans et documents techniques de toute nature réalisés ou mis en oeuvre par ses soins, ou sur les marques et plus généralement droits de propriété intellectuelle détenus par LEMAN.

XIII. IMPREVISION

Il est convenu expressément que les Parties acceptent les risques de changement de circonstances imprévisibles lors de la conclusion du Contrat rendant l'exécution excessivement onéreuse pour l'une ou l'autre des Parties.

XIV. PROTECTION DES DONNEES PERSONNELLES DES PERSONNES PHYSIQUES

LEMAN met en oeuvre des traitements de données à caractère personnel. LEMAN (Avenue de Savoie – BP 147 – 38354 LA TOUR DU PIN, immatriculée au RCS de BOURGOIN JALLIEU sous le numéro 306 807 223) est le responsable de ce traitement.

Il s'agit des données que le Client personne physique ou un représentant légal d'un Client fournit directement lors de la commande et/ou de la création d'un compte client (Civilité, Prénom et nom de famille, Adresse postale, Age et date de naissance, Adresse de courrier électronique, Numéro de téléphone, n°SIREN, n°SIRET, etc.). À tout moment, la personne physique – Client ou représentant légal d'un Client – dispose de la faculté de modifier ces informations en adressant à LEMAN un courrier électronique ou une lettre recommandée avec accusé de réception.

LEMAN recueille, enregistre, utilise et conserve les données à caractère personnel sur la base du consentement du Client et/ou de son représentant légal, du Contrat conclu avec le Client et de son intérêt légitime.

Le recueil, l'enregistrement, l'utilisation et la conservation des données ont pour finalité :

- la création du compte du Client**
- la gestion du compte Client**
- l'exécution et le suivi de la commande**
- la gestion des opérations de paiement et de livraison**
- la gestion de la relation Client**
- la gestion des communications et le suivi des échanges**
- la prospection commerciale**
- la gestion des demandes de droit d'accès, de rectification et d'opposition au traitement des données personnelles des personnes concernées ;**

Les informations personnelles collectées seront conservées aussi longtemps que nécessaire pour la gestion et le suivi de la commande du Client et la gestion et le suivi d'éventuels litiges qui pourraient survenir après la commande. Les données traitées sont archivées selon les durées de prescription et de conservation légales et notamment fiscales, commerciales et comptables.

Pour atteindre les finalités décrites ci-dessus et dans les limites nécessaires à la poursuite de ces finalités, les données du Client et/ou de son représentant légal pourront être transmises aux employés et préposés de LEMAN habilités à les traiter en raison de leurs fonctions. Les informations recueillies pourront également être transmises à des tiers liés à LEMAN par contrat pour l'exécution

de tâches sous-traitées nécessaires à la gestion et au suivi de la commande, à la gestion du compte Client, à la gestion et au suivi des opérations de paiement et de livraison sans qu'une autorisation du Client et/ou de son représentant légal soit nécessaire. Dans le cadre de l'exécution de leurs prestations, les tiers n'ont qu'un accès limité aux données et ont une obligation contractuelle de les utiliser en conformité avec les dispositions de la législation application en matière de protection des données personnelles.

Par ailleurs, d'autres destinataires peuvent avoir accès à tout ou partie des données personnelles selon leur degré d'habilitation et la finalité, à savoir notamment les services de police et les autorités judiciaires notamment en cas de réquisition judiciaire.

Conformément aux dispositions légales et réglementaires applicables, en particulier la loi n°78-17 du 6 janvier 1978 modifiée relative à l'informatique, aux fichiers et aux libertés et du règlement européen n°2016/679/UE du 27 avril 2016, le Client et/ou son représentant légal bénéficie d'un droit d'accès, de rectification, de portabilité et d'effacement de ses données (sauf si elles sont nécessaires à l'exécution du contrat, ou qu'elles sont nécessaires pour respecter les obligations légales de LEMAN ou constater ou exercer les droits de LEMAN) ou encore de limitation du traitement, ainsi que du droit de définir des directives relatives au sort de ses données après son décès. Il peut également, pour des motifs légitimes, s'opposer au traitement des données le

concernant et bénéficie d'un droit d'opposition à la prospection notamment commerciale.

Ces droits peuvent être exercés auprès de LEMAN qui a collecté les données à caractère personnel de la manière suivante : par courrier postal : Avenue de Savoie – BP 147 – 38354 LA TOUR DU PIN / par voie électronique france@leman-sa.com. La demande doit être accompagnée d'un justificatif d'identité.

Il est également possible pour le Client et/ou son représentant légal de formuler une réclamation auprès de la CNIL.

XV. LOI APPLICABLE - LITIGES

1. Les présentes Conditions Générales et le Contrat sont soumis au droit français.
2. TOUS LES LITIGES AUXQUELS LES CONDITIONS GENERALES ET LE CONTRAT POURRAIENT DONNER LIEU, CONCERNANT TANT LEUR VALIDITE, LEUR INTERPRETATION, LEUR EXECUTION, LEUR RESILIATION, LEURS CONSEQUENCES ET LEURS SUITES RELEVERONT DE LA COMPETENCE EXCLUSIVE DES JURIDICTIONS DEPENDANT DU SIEGE SOCIAL DE LEMAN.
3. Si le Client entend engager une action judiciaire, il devra impérativement l'introduire dans un délai d'un an à compter de la livraison ; passé ce délai son action sera prescrite.

LEMAN SAS

Capital de 885 000€ - R.C.S. BOURGOIN JALLIEU 84 B 88 – N° SIREN : 306 807 223 00053

N° d'identification TVA : FR 30 306 807 223 – APE 4662 Z

AVENUE DE SAVOIE · B.P.147 · SAINT-CLAIR DE LA TOUR · 38354 LA TOUR DU PIN CEDEX

Tél +33 (0)4 74 83 20 80 · Fax +33 (0)4 74 97 67 24

CARACTÉRISTIQUES TABLES ARTICLES

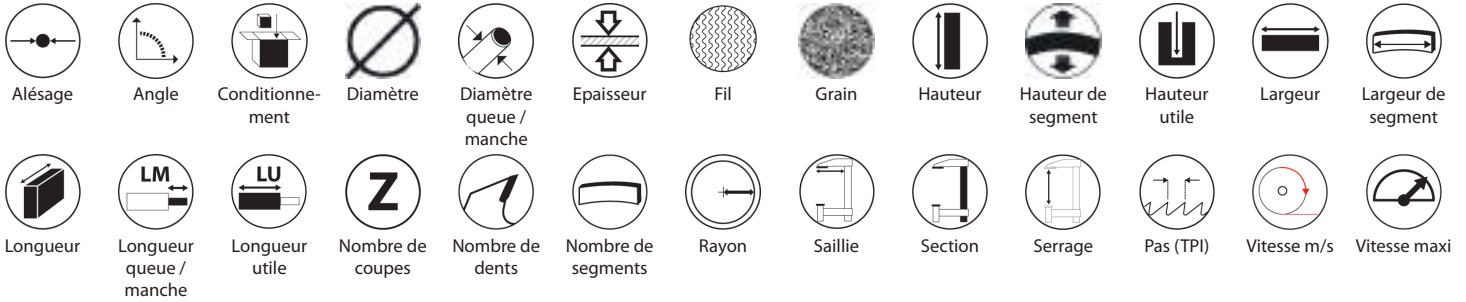

CARACTÉRISTIQUES PRODUITS

Dentures

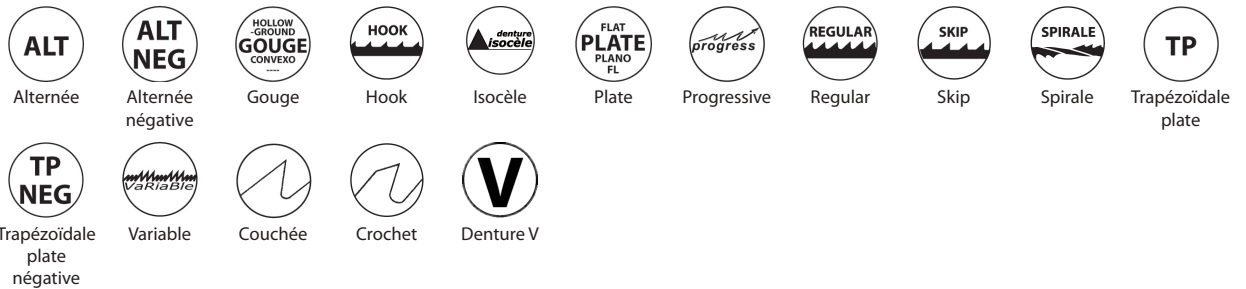

Affûtages

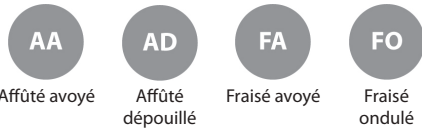

Emmanchements et fixations



Matière de l'outil

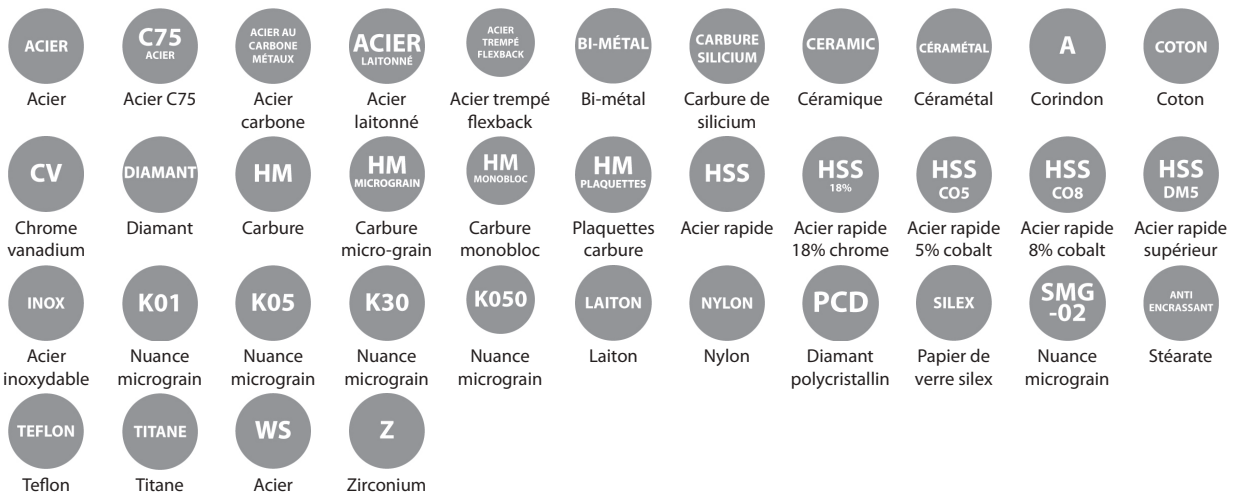

Conditionnements

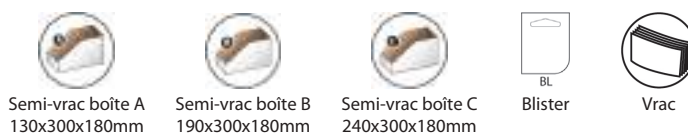

Conseils d'utilisation



LÉGENDE DES PICTOGRAMMES

Matériaux

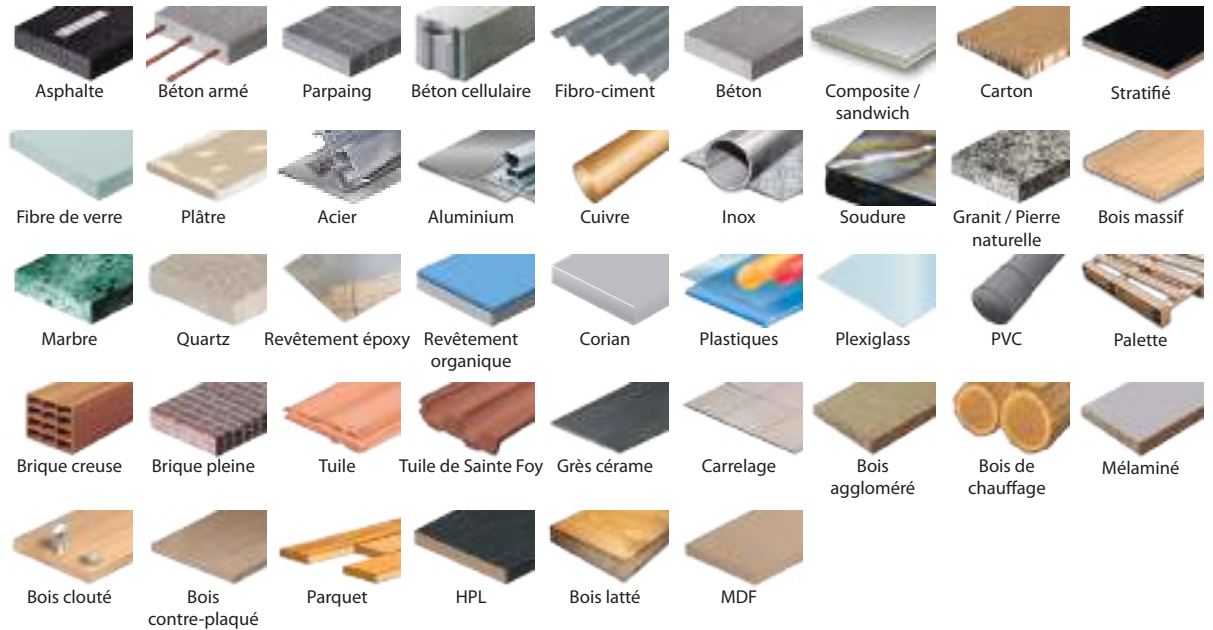

Avantages



Machines



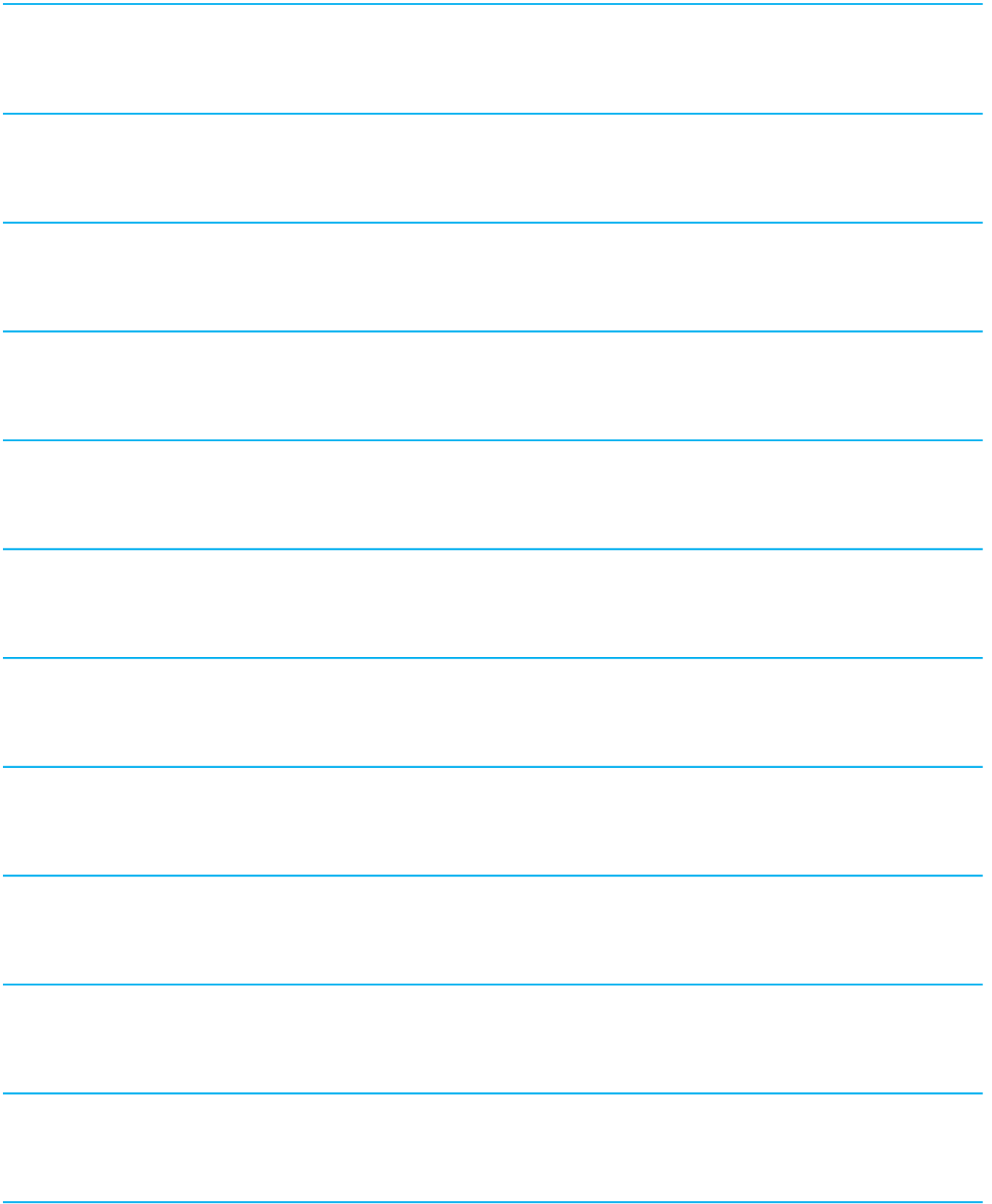

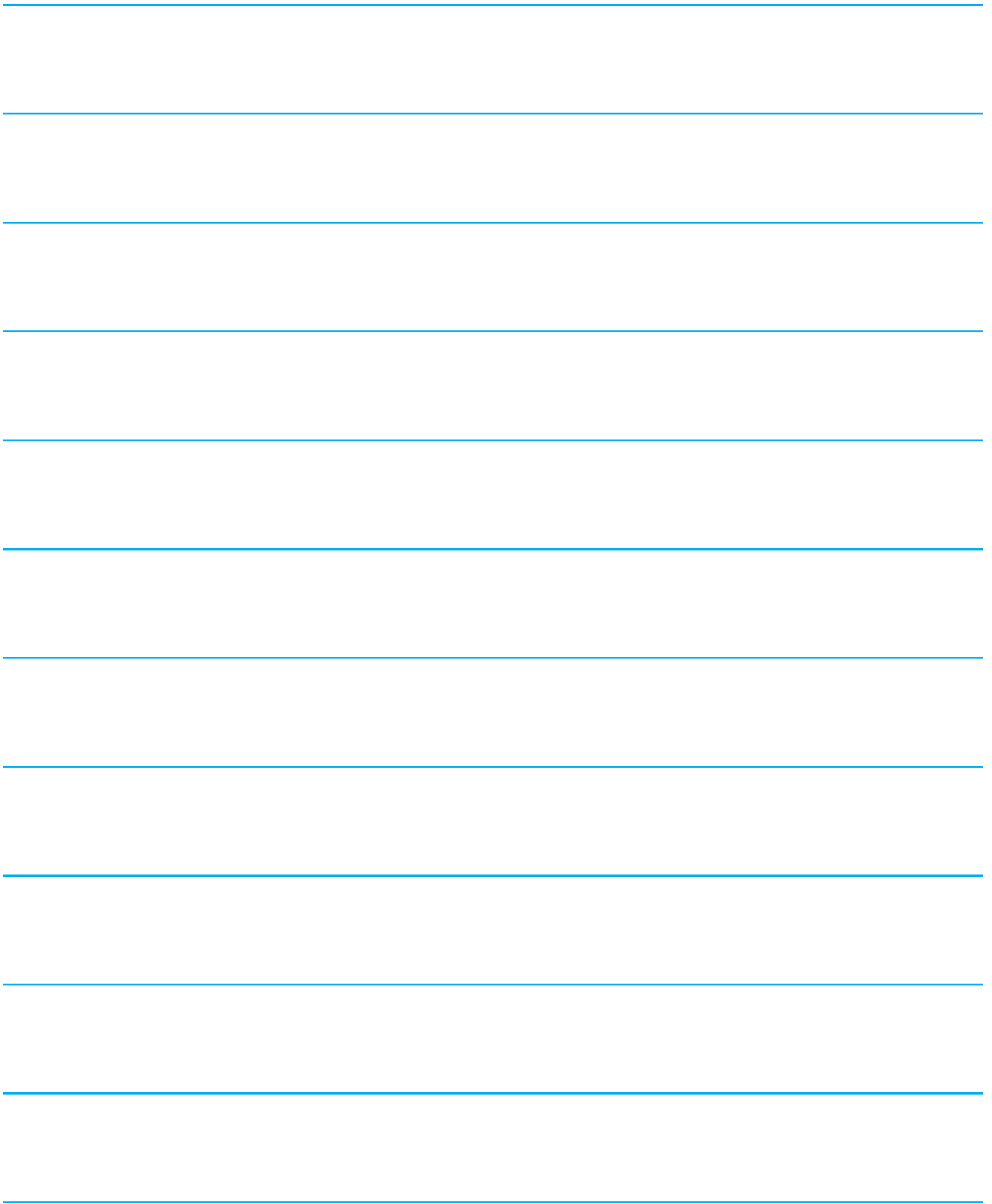



leman-sa.com

LEMAN[®]

PROFESSIONAL CUTTING SOLUTIONS

www.leman-sa.fr

LEMAN SAS

Avenue de Savoie
B.P. 147 - 38354
LA TOUR DU PIN CEDEX
FRANCE
france@leman-sa.com
Tél: + 33 04 74 83 20 83
Fax: + 33 04 74 83 20 82

LEMAN ESPAÑA

Export / Distribution Europe
C/Pujades, 51-55 Bo
08005 - BARCELONA
ESPAÑA
Tel: +34 934 127 461

LEMAN BALTIC

Kareiviu g. 6-202
09117 VILNIUS
LITHUANIA
baltic@leman-sa.com
Tél : +370 616 253 84
Fax : +370 454 424 41

LEMAN ITALIA SRL

Via Podgora 11 /
20122 MILANO
ITALIA
Mail : italia@leman-sa.com
Tél: +0039 3280 74 82 60

LEMAN PORT

Rua de Nossa Senhora da Maia, Nº77
1º Sala 16, 4470-204 Maia
PORTUGAL
fgoncalves@goncalvesegomes.com
Tel: +00351 93 313 04 59

LEMAN BENELUX

Rue de l'école, 4
1780 WEMMEL
BELGIUM
benelux@leman-sa.com
Tél : +32 2 251 12 70
Fax : +32 2 251 35 85

LEMAN GENEVA

Rue du Nant, 8
1207 GENEVA
SWITZERLAND
geneva@leman-sa.com
Tél : +33 04 74 83 20 83

CATLEMG2021



3 661589 097934



@lemanofficial



lemanvideo



@leman_official



@lemanpix



REVENDEUR